

CO 83 Access Control Plan

FINAL REPORT

October 2021

Prepared for:



In cooperation with:
El Paso County
City of Colorado Springs

Prepared by:
ATKINS
Member of the SNC-Lavalin Group

This page intentionally left blank.

Contents

Chapter	Page
1. Introduction.....	1
1.1. Project Overview	1
1.2. Study Limits	2
1.3. Objectives	3
1.4. Purpose	3
1.5. Need	4
1.6. Process.....	5
2. Corridor Conditions	7
2.1. Existing Corridor Access	7
2.2. Existing Corridor Traffic	8
2.3. Existing Intersection Analysis	8
2.4. Crash History	10
2.5. 2045 No-Action Corridor Conditions.....	14
2.6. Intersection Level of Service	15
3. Public Involvement.....	16
3.1. Property Owner Information	17
3.2. Initial Virtual Open House Meeting.....	17
3.3. One-on-One Property Owner Workshops	17
3.4. Second Virtual Open House Meeting	18
3.5. Second Virtual Meeting Follow-up.....	18
3.6. Project Meetings and Presentation to Elected Officials	18
4. Access Control Techniques.....	19
5. Access Recommendations.....	21
5.1. Roadway Sections and Access Descriptions	21
5.2. Level of Service Analysis.....	22
5.3. Crash Analysis.....	24
6. Next Steps	25
6.1. Approval Process	25
6.2. Plan Implementation.....	25
6.3. Plan Modification	27
7. References	29

Appendices

Appendix A.	ACP Legal Documents
Appendix B.	Existing Traffic Data
Appendix C.	Crash Data
Appendix D.	Results of Analysis
Appendix E.	Public Involvement Material

Figures

Figure 1. Study Area Limits	2
Figure 2. CO 83 ACP Process	5
Figure 3. Summary of Crash History between CO 21 and Old North Gate Road	11
Figure 4. Summary of Crash History between Old North Gate Road and Walker Road	12
Figure 5. Summary of Crash History between Walker Road and Palmer Divide Road.....	13
Figure 6. Methods of Access Control	19
Figure 7. ACP Implementation Process	26

Tables

Table 1. Future Growth Rates on CO 83	4
Table 2. Existing Access Conditions with Study Area	7
Table 3. Existing (2019) Average Daily Traffic.....	8
Table 4. Intersection LOS Criteria	9
Table 5. 2019 Existing Conditions Intersection LOS Results	10
Table 6. Projected (2045) Average Daily Traffic (vpd).....	15
Table 7. 2045 No-Action LOS Compared to 2019 Existing Conditions LOS	16
Table 8. Proposed Accesses by Study Area Section	21
Table 9. 2045 No-Action LOS Compared to 2045 LOS with ACP Implementation	23

Acronyms

ACP	Access Control Plan
ADT	Average daily traffic
AM	Morning peak hour
CCR	Code of Colorado Regulations
CDOT	Colorado Department of Transportation
City	City of Colorado Springs
CO	Colorado State Highway
County	El Paso County
E-X	Expressway
FHWA	Federal Highway Administration
GIS	Geographic Information System
HCM	Highway Capacity Manual
IGA	Inter-Governmental Agreement
LOS	level of service
MP	mile post
MUTCD	Manual on Uniform Traffic Control Devices
OTIS	Online Transportation Information System
PM	Evening peak hour
RIRO	right-in, right-out
R-A	Regional Highway
sec/veh	seconds per vehicle
SHAC	State Highway Access Code
TMC	turning movement count
TRB	Transportation Research Board
vpd	vehicles per day
vph	vehicles per hour

This page intentionally left blank.

1. Introduction

The Colorado Department of Transportation (CDOT) is developing an Access Control Plan (ACP) to address the future access needs within northern El Paso County along Colorado State Highway 83 (CO 83). The limits of the ACP are approximately 9.85 miles, beginning at the CO 21/Powers Boulevard southbound ramp and ending at County Line Road/Palmer Divide Road to the north. CO 83 is a north-south principal arterial roadway under CDOT jurisdiction. The ACP involved three stakeholders who ultimately will sign the Inter-Governmental Agreement (IGA), refer to **Appendix A**: CDOT, El Paso County (County), and the City of Colorado Springs (City).

Recent growth along the corridor has resulted in an increase in traffic on CO 83. Looking to the future, traffic volumes are expected to increase in the range of 17 percent to 86 percent along the corridor by the year 2045. Without changes to the highway, the projected increase in traffic volumes pose the potential to increase delay, produce higher levels of congestion/pollution, and expose all roadway users to an increase in the number of crashes.

The approved ACP will guide the agencies' decisions regarding the future access conditions while supporting the planning objectives of the City, County, and CDOT. The final recommendations of the ACP provide benefit to four primary areas of the transportation system: operations, safety, multi-modal, and future improvements. Some of the major findings and benefits of the ACP include:

- Changes in access conditions are identified, such as the elimination of an access or restriction on the type of turn movements allowed at a specific location. These recommendations will result in a reduction in the number of conflict points (locations where vehicles and/or pedestrians/bicycles cross paths with each other), which will improve overall safety for all transportation modes.
- The plan identifies the locations that may warrant the need for a traffic signal or conversion to a roundabout in the future to provide safe full movements for drivers along the highway. Clearly identifying the locations where a signal can be installed prevents the corridor from having too many traffic signals. While the locations where signals may be installed are established in the plan, no signal will be installed until warrants are met, which means that some intersections may remain unsignalized or may be candidates for conversion to another type of control such as a roundabout.
- The recommendations and conclusions in the ACP do not specify the future roadway footprint or laneage. The recommendations and conclusions do not prohibit future improvements to the roadway system along the corridor or on adjacent nearby streets. Efforts were made to identify possible future connectivity via roads or shared accesses that can alleviate the need for many direct accesses to the highway.

1.1. Project Overview

The implemented ACP will provide a binding document guiding the agencies' decisions regarding the future access conditions of CO 83. The State Highway Access Code (2 Code of Colorado Regulations [CCR] §601-1) requirements were followed in preparing this plan. The ACP will provide the City, County, and CDOT with roadway access planning documents in an effort to ensure that the CO 83 corridor remains consistent with its assigned access categories. The ACP is intended to support the planning objectives for the City, County, and CDOT. In addition, the ACP evaluates existing, planned (known developments underway), and proposed (locations where future development may occur) access points along CO 83 and makes recommendations for appropriate modifications.

1.2. Study Limits

The ACP limits begin to the south at the Powers Boulevard southbound ramp and end at County Line Road/Palmer Divide Avenue to the north. The limits of the evaluated portion of CO 83 are approximately between mile post (MP) 20.4 and MP 30.2. The total study area encompasses approximately 9.7 miles of roadway. The study area is shown in **Figure 1**.

Figure 1. Study Area Limits

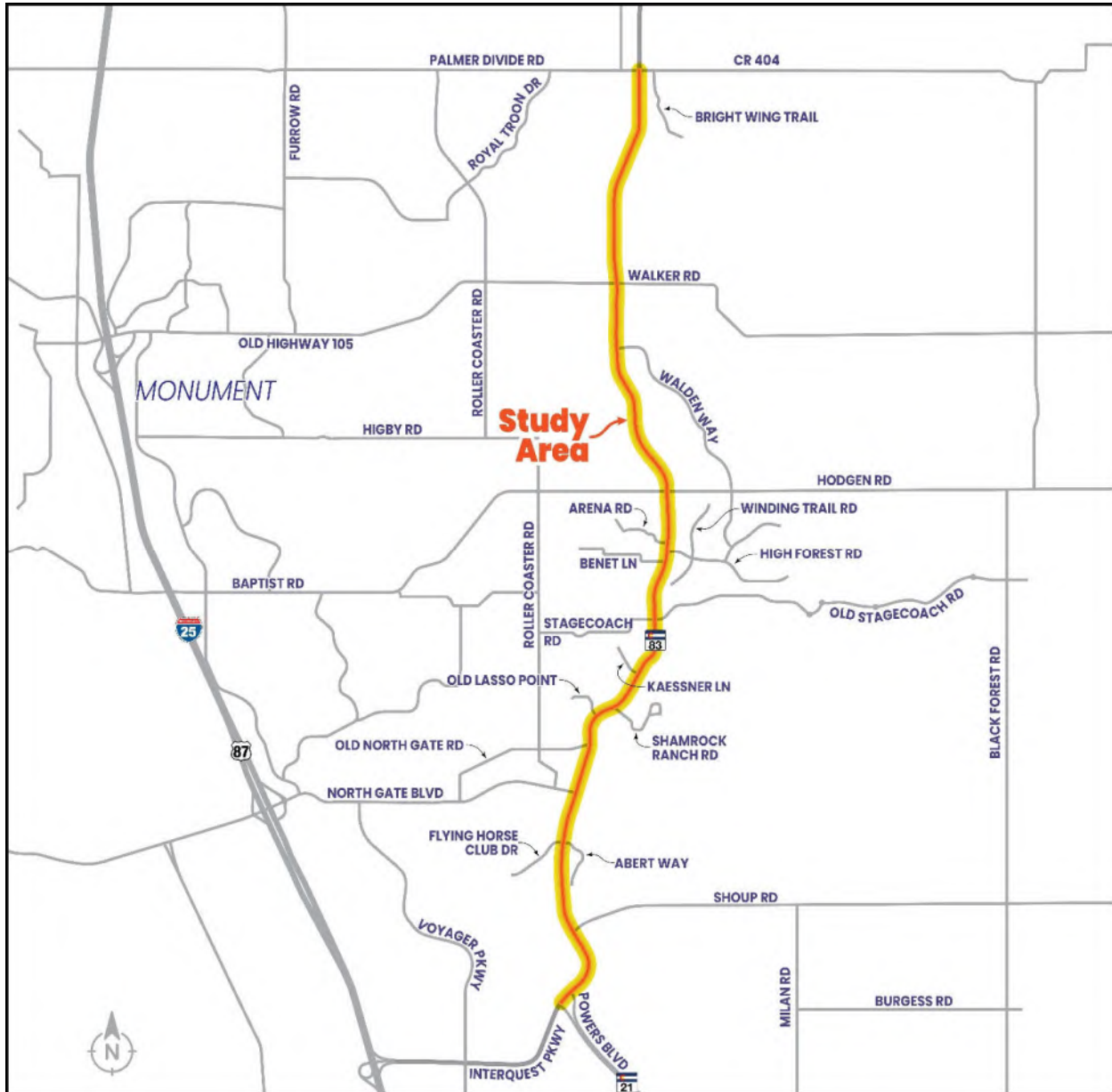

1.3. Objectives

Proper application of an ACP will allow all modes of transportation to move efficiently and safely along the study roadway by controlling the design, location, and frequency of access points and by better using the secondary or local roadway network to reduce future strain on the highway. The following are typical objectives of any ACP, including the CO 83 ACP:

- Provide effective and efficient through travel for traffic on the highway.
- Provide the appropriate level of access to properties adjacent to the study roadway.
- Maintain compatibility with existing and proposed off-system connections that provide local circulation to support the transportation system.
- Assist future development and redevelopment along CO 83 by identifying the locations and types of accesses.
- Maintain compatibility with previous and ongoing local planning efforts.
- Accommodate multi-modal transportation.

1.4. Purpose

The purpose of this ACP is to identify the location, type, and basic design elements of future access points within the study limits to provide reasonable access to adjacent properties while maintaining safe and efficient movement of all modes of transportation (vehicles, bicyclists, and pedestrians) along, adjacent to, or across CO 83.

According to the *State Highway Access Code March 2002 (SHAC)*, CDOT is required to provide access to individual properties when reasonable alternative access to the general street system does not exist and is not obtainable. CDOT has the ability to modify existing access points for safety and operational reasons and CDOT can recommend restricting the number of allowable vehicle movements. Without an ACP, all access to CO 83 would be governed strictly by the SHAC which in most cases would result in a more restrictive access conditions than what is recommended in the final ACP.

Changes in access are discussed in Section 2.6, “Changes in Land Use and Access Use” in the State Highway Access Code:

The Department or issuing authority may, when necessary for the improved safety and operation of the roadway, rebuild, modify, remove, or relocate any access, or redesign the highway including any auxiliary lane and allowable turning movement. The permittee and or current property owner will be notified of the change. Changes in roadway median design that may affect turning movements normally will not require a license modification hearing as an access permit confers no private rights to the permittee regarding the control of highway design or traffic operation even when that design affects access turning movements (p. 25, paragraph 7).

Furthermore, the ACP establishes when to implement access control from an operational standpoint and what types of access will be allowed, based on the standards set forth in the State Highway Access Code. According to Section 2.12, “Access Control Plans” of the State Highway Access Code:

The access control plan shall indicate existing and future access locations and all access related roadway access design elements, including traffic signals, that are to be modified and reconstructed, relocated, removed, added, or remain (p. 30, paragraph 2).

1.5. Need

To properly develop an ACP that will identify the appropriate access conditions to meet CDOT, City, and County’s long-range vision for the CO 83 corridor while achieving the project objectives, the study considered both the existing traffic conditions (2020) and the projected traffic conditions that are expected to occur by the long-range horizon year of 2045. The projected increase in traffic on the corridor was determined by forecasting traffic demand to 2045 based on the average annual growth from 2020. The current CDOT growth projections (from the CDOT Online Transportation Information System [OTIS] database) along CO 83 within the project limits of the ACP show a proposed growth factor varying between 1.17 and 1.86, as shown in **Table 1**.

Table 1. Future Growth Rates on CO 83

Start Location	End Location	Growth Factor
Palmer Divide Road	Walker Road	1.86
Walker Road	Hodgen Road	1.84
Hodgen Road	North Gate Boulevard	1.60
North Gate Boulevard	CO 21/Powers Boulevard	1.17

Source: El Paso County Travel Demand Model Forecasting

Numerous planned development projects were incorporated into the 2045 analysis. These development projects were identified by the County and City. Projected trip traffic for these developments was added to the final 2045 projected background traffic volume to account for additional demand along the CO 83 corridor and at the intersections near each of these planned developments.

Based on the projected traffic growth on the corridor (including the known planned developments), the number of conflicts, amount of delay, and level of congestion will increase without better access control. Proper control of the frequency, number, and location of access points on the study roadway can lead to the following reductions:

- Number and severity of crashes
- Delay experienced by motorists and multi-modal transportation users
- Pollution created by congested traffic conditions
- Congestion on CO 83 and the strain on the surrounding roads
- Number of consumers conducting business elsewhere

There are several ways to reduce the number and severity of crashes that occur on any roadway. First, crashes generally occur at locations where two vehicles conflict with each other. A potential conflict occurs each time vehicles turning at an access point cross paths with other roadway users (vehicle or pedestrian). If the number of conflict points increases, which is what occurs if additional access points are allowed, then the number of crashes on the roadways also increases. Conversely, if the number of conflict points is reduced, the number of crashes should decrease, creating safer roadways.

Second, some of the most severe crashes typically involve left-turn movements by vehicles attempting to enter or exit the roadway without the protection of traffic control devices, such as a traffic signal. With an ACP, some of the vehicle left-turn movements can be redirected to locations with a traffic signal where, under the protection of a green phase, the vehicles can either turn left onto or off of the highway. For other left turn movements, the ACP provides a road map for future highway improvement projects to plan for the need to provide U-turn options at intersections that are near to driveways or roads that are restricted to less than full movement. Additionally, pedestrians/bicyclists can more safely cross the highway at high-volume intersections under the protection of the “Walk” and “Do Not Walk” phases of a

traffic signal. Other options for reducing the potential for left-turn crashes are the use of roundabouts, 3/4-movement, or right-in, right-out (RIRO) only intersections.

To reduce vehicle congestion and delay, it is important to control the number of access points along the roadways as traffic increases. By allowing fewer accesses, vehicles do not have to slow as much or stop as often to turn into an access or allow vehicles to enter the roadway from access points. Additionally, future roadway improvement projects can use the recommendations from the ACP to assist in the decision-making process of where to consider the addition of deceleration and acceleration lanes, which help remove slower traffic from the highway mainline. By reducing the friction along the roadway, the roadway will not become strained by congestion and delay. Motorists will experience acceptable travel times and an overall safer and better driving experience, which may translate into maintaining return service for local businesses. Another benefit to reducing congestion on the study roadway is a reduction in the level of vehicle emissions, which reduces the level of air pollution along the corridor.

1.6. Process

The process followed in developing the CO 83 ACP is summarized in **Figure 2**.

Figure 2. CO 83 ACP Process

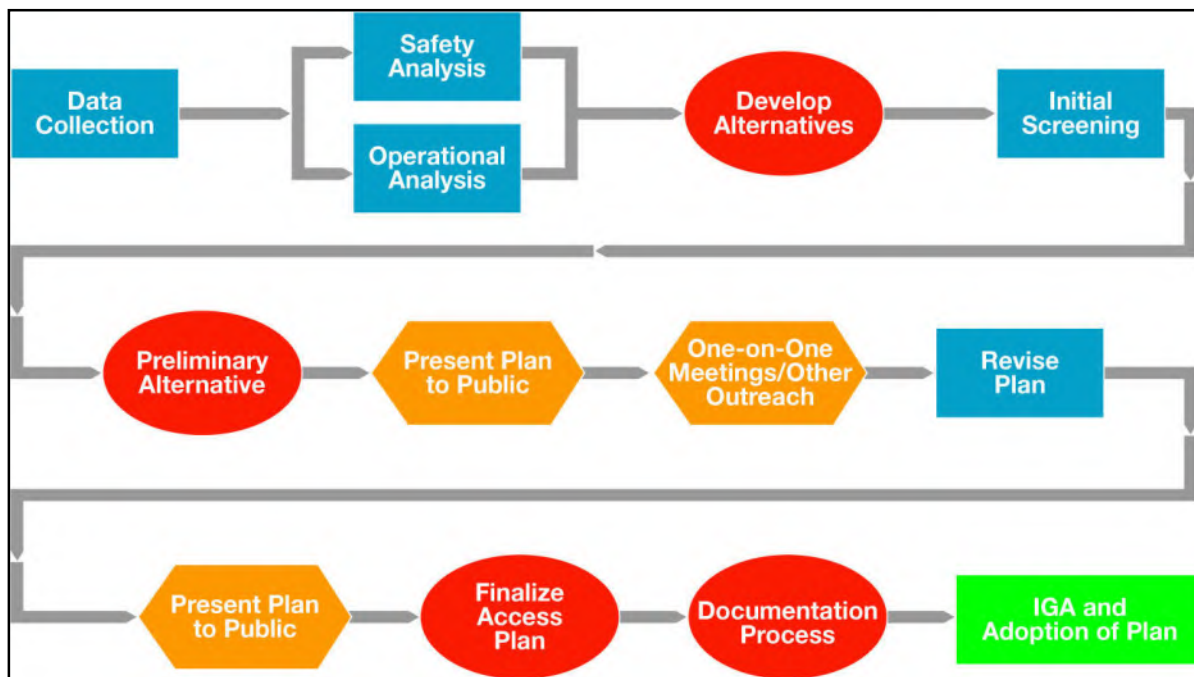

The process began with the data collection phase, during which all access locations were identified; traffic volumes (**Appendix B**) and crash data (**Appendix C**) were collected; and copies of relevant traffic/planning studies for the roadway were gathered. Traffic data was used to evaluate existing, future conditions without the ACP, and future with ACP conditions (**Appendix B**). Additionally, crash data was evaluated to identify locations where the crash patterns indicated a change in access may provide a benefit. The draft ACP was created based on the requirements of the SHAC, along with existing and planned access locations. The project team evaluated the alternatives to create a preliminary alternative, which then was presented to the public at a virtual open house. The initial public presentation served to introduce the project and the concept of access control to the public, as well as to present the preliminary recommendations. Comments were received from the public for further consideration. After the public presentation, additional outreach was conducted in the form of one-on-one property owner workshops to

identify solutions that best met the goals of the project and addressed the specific needs of those who signed up for the one-on-one meetings. The one-on-one meetings ensured that crucial public input was received and taken under consideration in the process. Based on all of the comments received, the ACP was revised to reflect a Preferred Alternative. The Preferred Alternative was presented at a final virtual public meeting where comments from the public were collected.

Additional public outreach included monthly project working meetings with the project team members. A final presentation was provided to the County's Transportation Advisory Committee, Planning Commission, and Board of County Commissioners to summarize the study process and complete the adoption process. Documentation of the overall ACP development and approval process occurred throughout. The recommended CO 83 ACP is contained within this final report. The plan adoption process started during the documentation process is expected to be completed by the end of 2021. Materials from the public outreach process, including exhibits, comment forms, and summary letters from one-on-one meetings, are included in the appendices of this document. **Appendix E** contains the intergovernmental agreement that was created and signed as part of the adoption process. Implementation of the ACP will occur in phases or incrementally over time based on the development and redevelopment process, available funding, and traffic or safety needs. The remaining sections of this report include the following discussion topics:

- Corridor conditions
- Public involvement process
- Access control techniques
- ACP recommendations
- Next steps

2. Corridor Conditions

This section provides a summary of the existing and future without the ACP conditions on CO 83 in terms of access, operations, and safety.

2.1. Existing Corridor Access

All access points can be separated into two categories: public ways or private driveways. Definitions relating to types of access are covered in 1.5, Definitions and Abbreviations, of the SHAC (pages 2-8):

“Public Way” means a highway, street, or road, open for use by the general public and under the control or jurisdiction of the appropriate local authority of Department and includes private roads open to the public.

“Driveway” means an access that is not a public street, road, or highway.

State highways are classified in accordance with the State Highway Access Category Assignment Schedule (2 CCR §601-1a), which was revised on August 13, 2013. The study area includes 9.85 miles of CO 83 from CO 21 (Powers Boulevard) to Palmer Divide Road (County Line Road) in north El Paso County. A review of the SHAC indicates that all portions of the study area are classified as either Expressway (E-X) or Regional Highway (R-A), as summarized in **Table 2**.

Table 2. Existing Access Conditions with Study Area

Section	Highway Category	Number of Accesses			Existing Traffic Signals	Segment Length (miles)
		Private Driveways	Public Road	Total		
CO 21 Southbound to Old North Gate Rd	E-X	3	9	12 ¹	5	2.75
Old North Gate Road to Walker Road	R-A	36	11	47 ²	2	5.00
Walker Road to Palmer Divide Road	R-A	11	2	13 ¹	1	2.10
Totals		50	22	72	8	9.85

1. All access locations are full movement.

2. Forty-six locations are full movement, and one access location is a right-in only driveway.

Per the SHAC, E-X are governed by the following characteristics:

- Intended to accommodate high traffic volumes at high travel speeds over long distances in a safe and efficient manner.
- Prioritize movement of traffic over access to private property.
- If the property has access to a local road, direct access to the highway will be prohibited.

R-A are governed by the following characteristics:

- The capacity to handle medium to high travel speeds and relatively medium to high traffic volumes in a safe and efficient manner.

- Provides interregional, intra-regional, and intercity travel needs.
- Provides service to through traffic movements with a lower priority on providing direct access to adjacent properties.

If an access meets established signal warrant criteria, it has the potential to become signalized in the future. According to the SHAC, the preferred spacing between signalized intersections is one mile for EX category and 0.5 mile for R-A category highways. Not all public roadways that access CO 83 are appropriate locations for traffic signals if the roadway is to remain in compliance with the SHAC. Hence, an ACP identifies locations where signals can be installed if warrants are met. Without the proper planning, such as the development of an ACP, signals may end up being placed at inappropriate locations, which may preclude the ability to provide appropriate traffic control at needed intersections in the future to benefit the entire system.

2.2. Existing Corridor Traffic

The project team collected intersection turning movement counts (TMCs) at most major intersections and average data traffic (ADT) data at several locations on CO 83 in September 2020 and the detailed data is available in **Appendix B**. Prior to using the volume to analyze the conditions on CO 83, adjustment factors were applied to better represent true CO 83 volumes. First, an analysis was completed to determine the impact of COVID-19 on traffic volumes. When traffic counts were collected in September 2020, the volume of traffic on most highways had decreased due to COVID compared to pre-COVID conditions and had not yet returned to historically normal conditions. Thus, based on historic data from CDOT and other sources, the ADT and TMC were adjusted to account for the reduction due to COVID. Second, I-25 is currently under construction in the vicinity of this corridor, which has resulted in a portion of traffic diverting onto CO 83 to avoid delays caused by the construction activities. Again, an analysis was done to determine a reasonable correct factor that was applied to the TMC and ADTs to reduce traffic volume to align with historic data and growth trends.

The adjusted ADTs for CO 83 are shown in **Table 3**. These values represent a typical weekday traffic level along CO 83. The volumes are highest at the south end of the study area between Shoup Road and CO 21 and lowest at the north end between Hodgen Road and Palmer Divide Road. The volumes build from a low point in the rural part of the study area and increase the further south one travels, which is also where more of the adjacent land is developed. A deeper look into the volumes shows that traffic is heavier in the southbound direction in the morning and northbound in the evening. This is consistent with drivers commuting into Colorado Springs in the morning and returning home in the evening.

Table 3. Existing (2019) Average Daily Traffic

Location	Northbound (vpd)*	Southbound (vpd)	Total (vpd)
South of Palmer Divide Road	3,610 (5% Trucks)	3,905 (3% Trucks)	7,515 (4% Trucks)
North of Hodgen Road	4,350 (5% Trucks)	4,965 (4% Trucks)	9,315 (4% Trucks)
South of Hodgen Road	4,810 (3% Trucks)	5,440 (2% Trucks)	10,250 (2% Trucks)
North of Shoup Road	10,445 (4% Trucks)	10,140 (4% Trucks)	20,595 (4% Trucks)
South of Shoup Road	11,250 (5% Trucks)	11,825 (5% Trucks)	23,075 (5% Trucks)

* Vehicles per day (vpd)

2.3. Existing Intersection Analysis

Traffic operations for each of the signalized and key unsignalized access points were analyzed using the methods described in the *Highway Capacity Manual 6th Edition* (HCM) (Transportation Research Board [TRB], 2016). According to the HCM, the overall performance of an intersection is determined based on

the length of delay, expressed as seconds per vehicle (sec/veh), experienced by motorists at the intersection. Depending on the length of delay that is experienced, each intersection can be scored on a level of service (LOS) scale and given a letter grade from LOS A to LOS F, with LOS A being the best possible grade for the intersection and grades of LOS D or better being considered acceptable operations. For signalized intersections, the delay for each individual turning movement is evaluated, then entire approaches are graded, and finally the intersection as a whole can be given a single LOS. For two-way stop-controlled intersections, each minor approach is given a separate LOS and the worst LOS is reported as a single rating for the intersection. For analysis purposes, all uncontrolled intersections/driveways were treated as stop-controlled access points. **Table 4** shows the criteria for establishing the LOS for the signalized and two-way stop-controlled intersections within the study area.

Table 4. Intersection LOS Criteria

Level of Service	Control Delay (sec/veh)	
	Unsignalized Intersection (Two-Way Stop-Controlled)	Signalized Intersection
A	0-10	≤10
B	>10-15	>10-20
C	>15-25	>20-35
D	>25-35	>35-55
E	>35-50	>55-80
F	>50	>80

Source: 2016 HCM

The adjusted TMC data provides distribution information for vehicles entering and exiting the study roadway at key intersections. These traffic data were input into the Synchro traffic model prepared for this study to determine LOS during the morning (AM) and evening (PM) peak hours. The results of the LOS analysis for the existing conditions are presented in **Table 5**, with detailed analysis sheets provided in **Appendix D**. Based on the results of the analysis, the majority of the intersections and driveways operate at LOS C or better (shown with blue, dark green, or light green backgrounds in the table) during the peak hours of the day. The only exception is the intersections of Stagecoach Road during the PM peak, which operate at LOS D. Even LOS D is considered acceptable operations.

Table 5. 2019 Existing Conditions Intersection LOS Results

Intersection	LOS/Delay (sec/veh)	
	AM	PM
Powers Blvd SB*	A/2	A/6
Powers Blvd NB*	C/24	B/15
CDOT Yard	B/13	C/19
Shoup Rd*	B/11	A/9
Flying Horse Club Dr/Abert Way*	B/12	B/13
North Gate Blvd*	C/21	C/21
Private Access (east of CO 83)	B/12	C/19
Old North Gate Road	C/15	B/14
Old Lasso Point	B/12	A/0
Shamrock Ranch Rd	A/0	A/0
Kaessner Lane	B/12	C/15
Stagecoach Rd	C/17	D/27
Private Access (west of CO 83)	B/15	C/21
Benet Lane	B/12	C/16
High Forest Rd	C/16	C/20
Arena Rd	B/12	C/17
Hogden Rd*	C/30	C/30
Walden Way	B/13	B/14
Walker Road/CR 105*	C/21	B/19
E Palmer Divide Ave*	B/11	B/10

Note: Blue = LOS A, Dark Green = LOS B, Light Green = LOS C, Orange = LOS D, Red = LOS E, Dark Red = LOS F

*Signalized intersection

2.4. Crash History

A summary of crash data that covered five years (December 31, 2014 to December 31, 2019) was provided by the CDOT Region 2 Traffic Unit. Detailed data related to the crash history on CO 83 can be found in **Appendix C**. The number of crashes by location are summarized in **Figure 3**, **Figure 4**, and **Figure 5**.

Overall, the study area has a higher-than-expected crash rate (depicted by the number of highway segments that are orange or red) based on a comparison to other highways with similar characteristics such as number of lanes, type of urban area, volumes, and intersection spacing. There are also five intersections that have a higher-than-expected crash history (shown with an orange inner circle around the number of crashes). This means that there is a moderate to high potential for crash reduction along the study area and particularly at the five intersections.

Figure 3. Summary of Crash History between CO 21 and Old North Gate Road

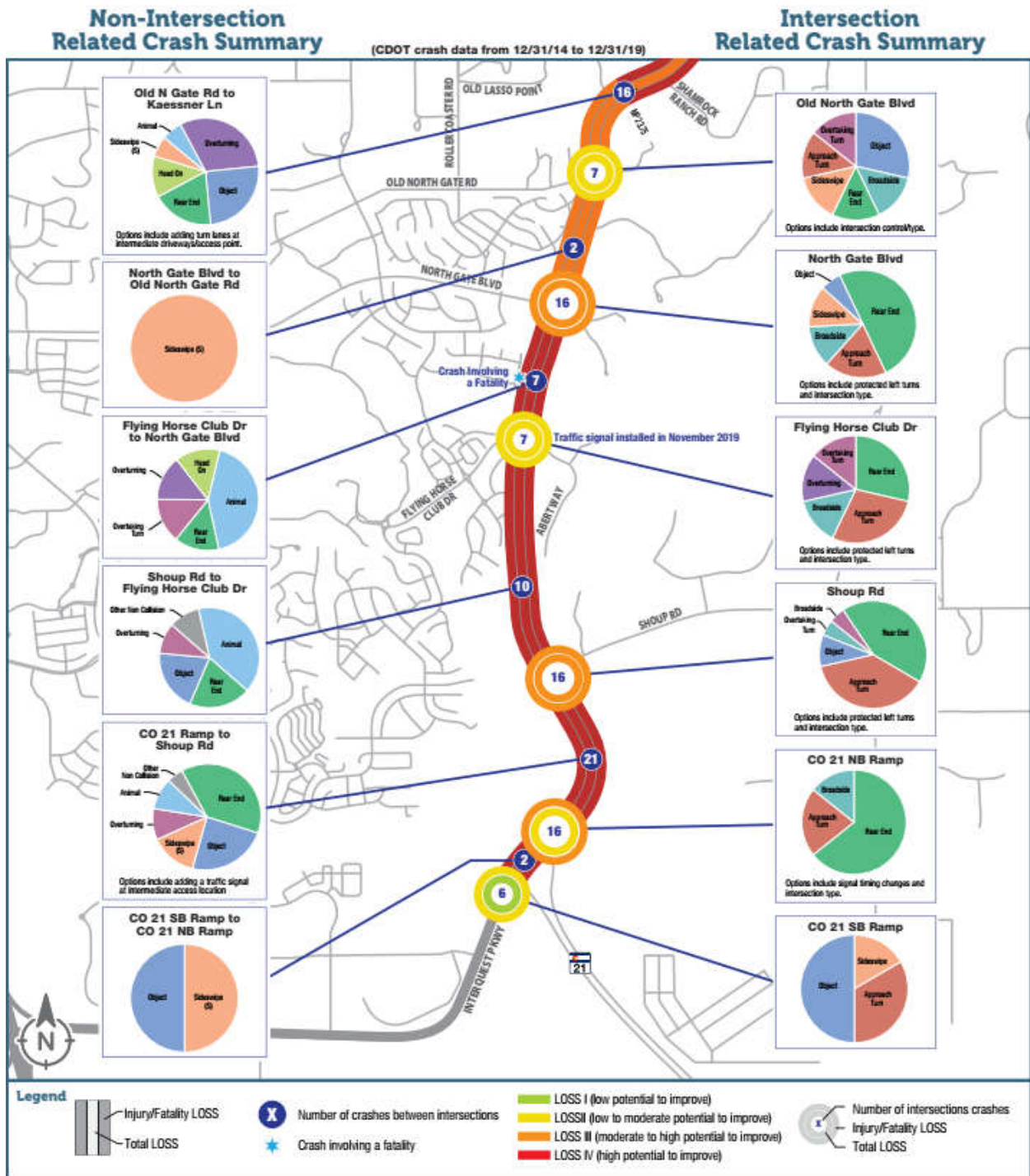

Source: CDOT crash data from 12/31/2014 to 12/31/2019

Figure 4. Summary of Crash History between Old North Gate Road and Walker Road

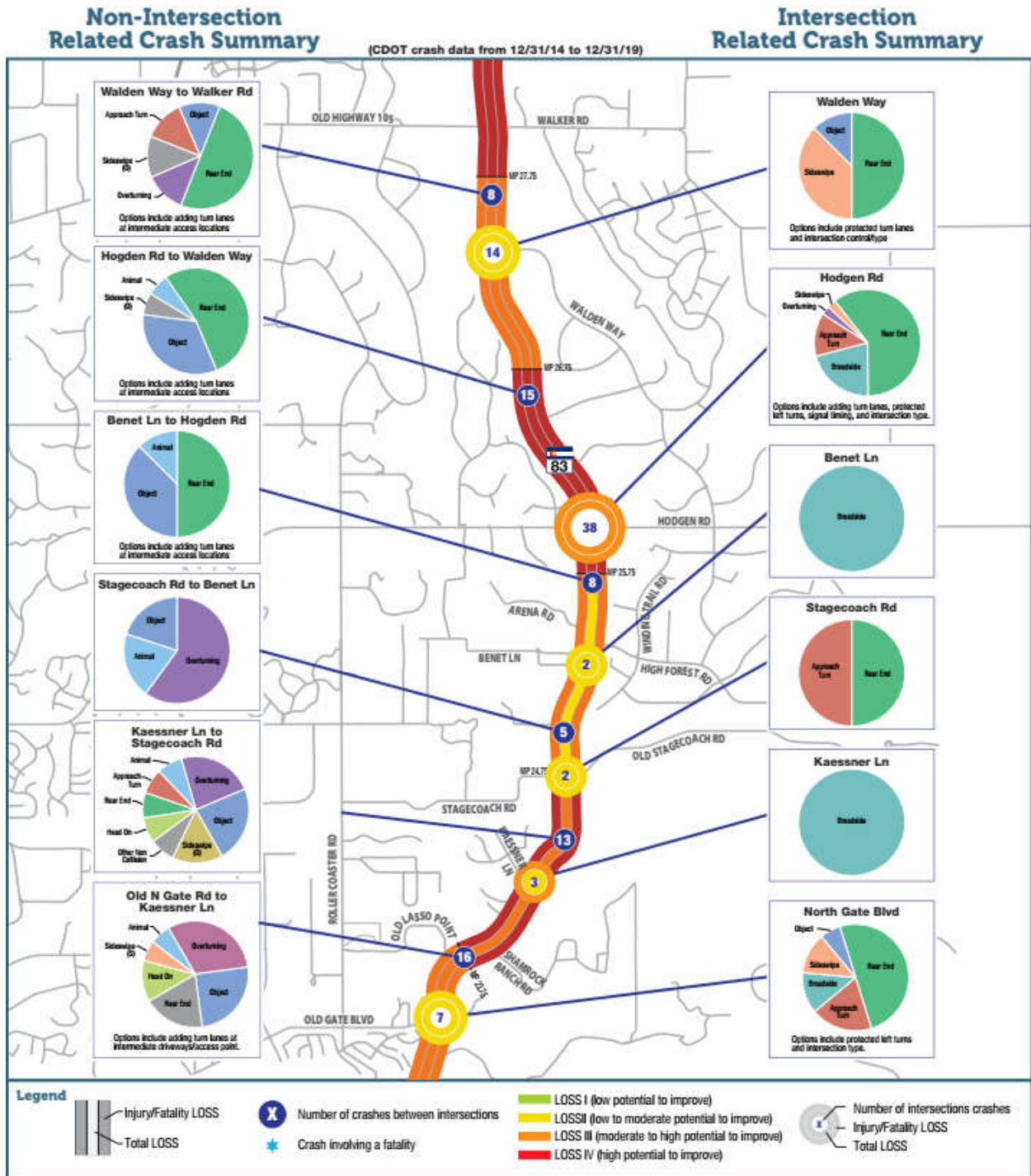

Source: CDOT crash data from 12/31/2014 to 12/31/2019

Figure 5. Summary of Crash History between Walker Road and Palmer Divide Road

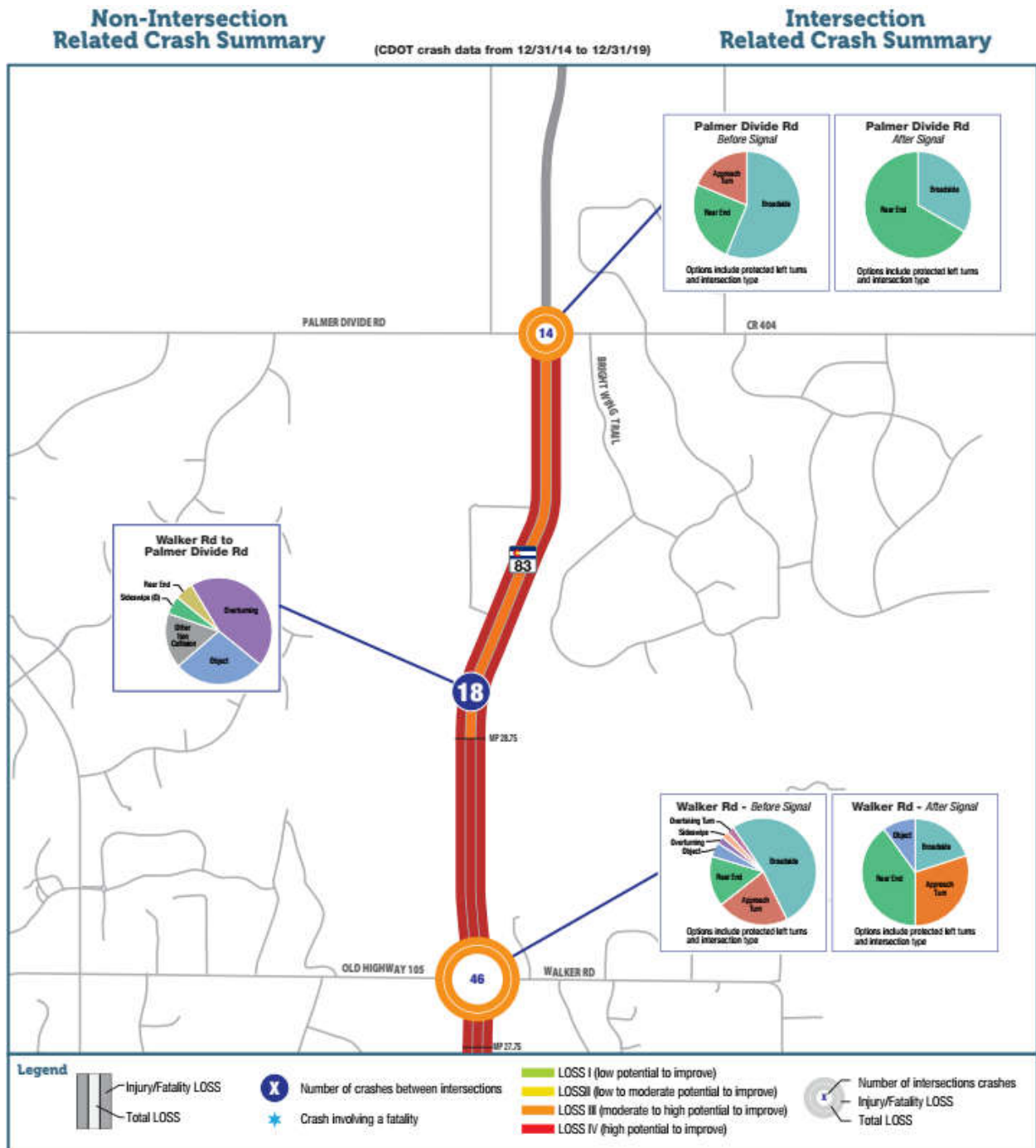

Source: CDOT crash data from 12/31/2014 to 12/31/2019

Some of the key observations of safety on CO 83 based on the crash data indicates the following:

- During the five years of collected crash data, there were a total of 333 crashes and a review of the data indicated that a majority of crashes fit into one of the following types:
 - **Rear End (116 events).** This crash typically occurs when one vehicle strikes the rear of the vehicle in front of it because that vehicle is stopped or slowing down.
 - **Broadside (50 events).** This type of crash typically occurs when a vehicle traveling through an intersection strikes a left-turning vehicle at a 90-degree angle; both vehicles are on the same road.
 - **Approach Turn (41 events).** This type of crash typically occurs when a vehicle traveling through an intersection strikes a left-turning vehicle at a 90-degree angle; the vehicles are on different roads.
 - **Overtaking Turn (6 events).** This type of crash typically occurs when two adjacent approach vehicles, whose paths are unintended to come in conflict, collide as a result of one or both vehicles over-turning and under-turning. This type of crash may include a vehicle initially going straight but leaving its proper travel lane and colliding with a stopped or moving vehicle on an adjacent approach road or driveway.
 - **Sideswipe (23 events).** This type of crash typically involves the side of one vehicle contacting the side of another vehicle that is traveling in the same or opposite direction.
 - **Other (97 events).** This category is a catch-all that includes crashes that typically involve a vehicle that overturns, a vehicle that strikes a fixed object, a vehicle striking a wild animal, or two vehicles striking each other in a head-on event.
- The majority of crashes occurred at intersections (209), with the highest frequency at the signalized intersections and the most common types of crashes were rear-end or broadside at these locations.
- There was a total of 124 crashes at non-intersection locations, many of these were animal strikes, vehicles overturning, or vehicles running off the road and striking objects.
- There were no reported crashes involving pedestrians or bicyclists.

Based on the crash data, the following changes could be considered to help reduce the occurrence of future crashes within the study area:

- Reducing the number of access locations will reduce the number of conflict points, resulting in a reduction in the number of rear-end crashes.
- The use of protected-only left-turn movements at signalized intersections may reduce the frequency and severity of left-turn crashes.
- The conversion of stop-controlled full-movement intersections to three-quarter movements or RIRO movements would help improve safety and reduce crashes.
- Installing traffic signals or other intersection designs such as roundabouts at intersections that warrant this change in traffic control should be considered.
- Addition of traffic signals or dedicated crosswalks to provide safer mobility options for pedestrians/bicyclists across CO 83 in the future should be considered.
- The use of other access optimization methods should be considered to help reduce the number of turning vehicles, increase spacing between driveways, and eliminate access locations that are too close to intersections.

2.5. 2045 No-Action Corridor Conditions

In addition to analyzing the existing traffic conditions, it is important to understand future planning horizons in developing recommendations for the ACP. The year 2045 was selected as the long-range planning horizon for this project. Before the future intersection and roadway operational analyses could be performed, future traffic volumes for the year 2045 were developed.

For the no-action condition, all access locations, types, and traffic controls are assumed to remain unchanged from existing conditions (refer to previous sections for description of access locations under existing conditions).

Future background volumes were projected by first applying the determined growth factors by segment to the existing volumes. The growth rates were between 1.17 at the south end of the study area and 1.9 at the north end, which are based on El Paso County’s projections for the corridor. **Table 6** shows a comparison between Existing (2019) and the projected 2045 bi-directional (southbound plus northbound) traffic along CO 83 at similar locations as was discussed for existing conditions. Projected trip traffic for the known developments as provided by City, County, and CDOT staff was added to the final 2045 projected traffic volume to account for additional demand along the CO 83 corridor and at the intersections near each of these planned developments.

Table 6. Projected (2045) Average Daily Traffic (vpd)

Location	Existing	2045	Growth Factor
South of Palmer Divide Road	7,515 (4% Trucks)	14,000 (4% Trucks)	1.86
North of Hodgen Road	9,315 (4% Trucks)	17,150 (4% Trucks)	1.84
South of Hodgen Road	10,250 (2% Trucks)	16,460 (2% Trucks)	1.60
North of Shoup Road	20,595 (4% Trucks)	24,710 (4% Trucks)	1.20
South of Shoup Road	23,075 (5% Trucks)	27,020 (5% Trucks)	1.17

2.6. Intersection Level of Service

The future peak hour traffic volumes were input into the traffic analysis model to determine intersection LOS. For comparative purposes, no changes to the traffic control at any intersection/access point were assumed for the no-action condition analysis. The model was updated to reflect future additional lanes on CO 83 based on long range plans from the County to add one additional lane in each direction of CO 83 between Old North Gate Road and Palmer Divide Road. **Table 7** summarizes the results of the intersection LOS for the no-action analysis compared to the existing conditions analysis. Several of the intersections will operate at a failing LOS (LOS E, LOS F) during the AM and PM peak hours for the 2045 no-action scenario. Detailed analysis of the LOS for year 2045 with no changes to the existing access configuration can be found in **Appendix C**.

In the year 2045, most of the driveways and intersections within the study limits will operate at LOS that is worse than Existing Conditions during both AM and PM peak hours if no changes are made to access on the corridor. Some of the stop-controlled access locations will experience long delays (LOS E or F). Overall, access to and from CO 83 will become more difficult and less safe without changes to the access conditions. These results indicate congestion levels on CO 83 will continue to increase in the future and will result in poor operations, long delays, and fewer acceptable gaps in traffic for vehicles to complete turns or enter the highway. As traffic volumes increase, these conditions will be worse if the number, design, and location of access locations along the study roadway are not controlled through the development of an ACP. The results also indicate that several of the driveways and intersections may be subject to having turn restrictions imposed or full closure to maintain safe and efficient operations if no improvements are done.

Table 7. 2045 No-Action LOS Compared to 2019 Existing Conditions LOS

Intersection	LOS/Delay (sec/veh)			
	Existing (2019)		No-Action (2045)	
	AM	PM	AM	PM
Powers Blvd SB*	A/2	A/6	D/37	C/27
Powers Blvd NB*	C/24	B/15	C/30	C/25
CDOT Yard	B/13	C/19	B/15	D/32
Shoup Rd*	B/11	A/9	B/20	C/31
Flying Horse Club Dr/Abert Way*	B/12	B/13	C/24	C/21
North Gate Blvd*	C/21	C/21	D/40	C/30
Private Access (east of CO 83)	B/12	C/19	B/13	F/65
Old North Gate Road	C/15	B/14	C/19	C/17
Old Lasso Point	B/12	A/0	F/77	F/103
Shamrock Ranch Rd	A/0	A/0	C/18	D/30
Kaessner Lane	B/12	C/15	B/12	C/20
Stagecoach Rd	C/17	D/27	A/8	B/11
Private Access (west of CO 83)	B/15	C/21	C/18	D/30
Benet Lane	B/12	C/16	C/17	C/24
High Forest Rd	C/16	C/20	C/21	E/41
Arena Rd	B/12	C/17	C/17	C/19
Hogden Rd*	C/30	C/30	D/38	E/62
Walden Way	B/13	B/14	E/36	D/33
Walker Road/CR 105*	C/21	B/19	E/65	D/54
E Palmer Divide Ave*	B/11	B/10	C/23	C/25

Note: Blue = LOS A, Dark Green = LOS B, Light Green = LOS C, Orange = LOS D, Red = LOS E, Dark Red = LOS F

* Signalized intersection

3. Public Involvement

The SHAC requires at least one advertised public meeting be held during the development of an ACP. For this particular ACP, an extensive public involvement process was followed:

- Identification of potentially affected property owner information
- Initial virtual Open House meeting
- One-on-one property owner/representative workshops
- Second virtual Open House meeting
- Second set of one-on-one property owner/representative workshops
- Website postings/project email
- Project meetings and presentation to elected officials

3.1. Property Owner Information

Property ownership data were obtained from Geographic Information System (GIS) property data files. A mailing list for the public involvement process was developed by Atkins and approved by the stakeholders. All properties within approximately 500 feet of CO 83 received information via mail about the study. This was done in an effort to ensure accurate and up-to-date information was used for the study, to ensure all parties received equal information, and to allow the property owners to determine whether they had an interest in the ACP.

3.2. Initial Virtual Open House Meeting

Due to COVID-19 pandemic restrictions, the stakeholders decided to conduct virtual public meetings instead of in-person open houses. The initial ACP virtual meeting was held in February of 2021. The virtual meeting was advertised via mailed postcards to property owners, business owners, and residents, as well as on the stakeholder websites. The meeting was also advertised in numerous newspapers and efforts were completed to send information direction to many of the homeowner associations in the area. The purpose of the open house was to identify the study's purpose, process, and schedule; provide information about the methods and benefits of access management; present the draft ACP; and receive comments from the public. The public was able to provide comments via a comment form that was submitted directly to the project team. A copy of the meeting materials and comments received can be found in **Appendix E**. The comments received were taken into consideration during the development of the recommendations in the ACP. Overall, the virtual meeting had more than 100 visits from the public and numerous comments were received. The comments were broken into two categories: ones that provided feedback that was not related to the access control plan (speed limits, truck restriction, noise, etc.) and property owners with significant impacts or concerns (driveways being closed, location of new roads, sharing access with other properties, etc.). The project team provided email responses to all of the individuals in the first category. The property owners in the second category were provided the opportunity to meet one-on-one with the project team to discuss their access issues in more detail and to determine the final preferred access alternatives.

3.3. One-on-One Property Owner Workshops

Several property owners/representatives were identified as needing additional time to discuss their specific access issues with the project team. To accommodate these individuals, one-on-one video conferences were scheduled between the property owners and the project team. Copies of letters sent to the participants of the one-on-one workshops, which summarize the discussion topics and agreements made during the meetings, can be found in **Appendix E**. Members of the project team were on hand at the meetings to present the draft ACP, listen to comments from the property owners, and, when necessary, identify additional access alternatives to address the concerns of the property owners and ensure the goals of the project were met. The comments from the meetings were used to refine the draft ACP and develop a final proposed ACP. The following property owners/representatives took part in the workshops:

- Justin Ensor for the property at 14650 Highway 83 (private residence)
- Delroy Johnson for the property at 14502 Highway 83 (private residence)
- Kim and Chuck Kruger for the property at 14405 Highway 83 (private residence)
- Ann and Gary Harris for the property at 14425 Highway 83 (private residence)
- Anthony Peterson for the property at 2725 Rustic Oak Grove (private residence)
- Andy Stauffer for the property at 3220 Outlook Drive (private residence)
- Ken Wolf for the property at 15040 Highway 83 (private residence)

3.4. Second Virtual Open House Meeting

A second virtual meeting was held in June 2021. The virtual meeting was advertised via mailed postcards to property owners, business owners, and residents, as well as on the stakeholder websites. The meeting was also advertised in numerous newspapers and efforts were completed to send information direction to many of the homeowner associations in the area. The purpose of the open house was to present basic information about what access control is, present the recommended final access configuration for the study roadway, provide a project schedule, discuss how the plan would be implemented, and gather comments and feedback from the public. The public was able to provide comments via a comment form that was submitted directly to the project team. A copy of the meeting materials and comments received can be found in **Appendix E**. The comments received were taken into consideration during the development of the recommendations in the ACP.

In addition, the comments received were used to identify individual property owners with the potential to identify the property owners with significant impacts or concerns. These property owners were provided the opportunity to meet one-on-one with the project team to discuss their access issues in more detail and to determine the final preferred access alternatives.

3.5. Second Virtual Meeting Follow-up

After the second virtual meeting, the project team provided feedback to some of the public comments in the form of email responses. Copies of emails sent to the participants of the second round of one-on-one workshops, which summarize the discussion topics and agreements made during the meetings, can be found in **Appendix E**. The following property owners/representatives took part in the workshops:

- Brett Gardner for the property at 2685 Crooked Vine Court (private residence)
- Brian Pickle for the property at 15655 Highway 83 (private residence)
- Kim and Chuck Kruger for the property at 14405 Highway 83 (private residence)
- Curtis Dicke for the property at 3095 Outlook Drive (private residence)
- Gary and Carol Cox for the property at 15740 Highway 83 (private residence)
- Gary Helfeldt – no address provided
- John Budnella for the property at 3035 Stagecoach Road (private residence)
- John Godsey for the property at 3235 Pinehurst Circle (private residence)
- Linda Famula for the property at 17368 Cabin Hill Lane (private residence)
- Robert and Linda Hutchinson for the property at 15960 Highway 83 (private residence)
- Shannon Baker for the property at 12950 Penfold Drive (private residence)
- Susan Gindhart for the property at 3045 Outlook Drive (private residence)

3.6. Project Meetings and Presentation to Elected Officials

Throughout the duration of the study, the project team conducted monthly working meetings to discuss the current status of the project, review decisions, make recommendations, identify issues, and provide an opportunity to receive input and comments from the public. As part of the public involvement for this study, presentations to the County Highway Advisory Commission, County Planning Commission, and the Board of County Commissioners were conducted. The purpose of the presentations was to summarize the process, review the recommendations, request that the officials accept the ACP, and begin the implementation phase of the ACP through the official adoption and signing of the IGA with CDOT. This presentation can be found in **Appendix E**.

4. Access Control Techniques

There are several options that allow changes to the existing roadway configuration or geometry to assist in the management of the number, frequency, and location of intersections/driveways along a roadway. Each option provides a different means to manage access along a roadway. In addition, each option has unique benefits and can be used in conjunction with other options to help improve traffic flow, operations, and safety while maintaining adequate access to the adjacent land uses. The following access control options, shown in **Figure 6**, are the most common.

Figure 6. Methods of Access Control

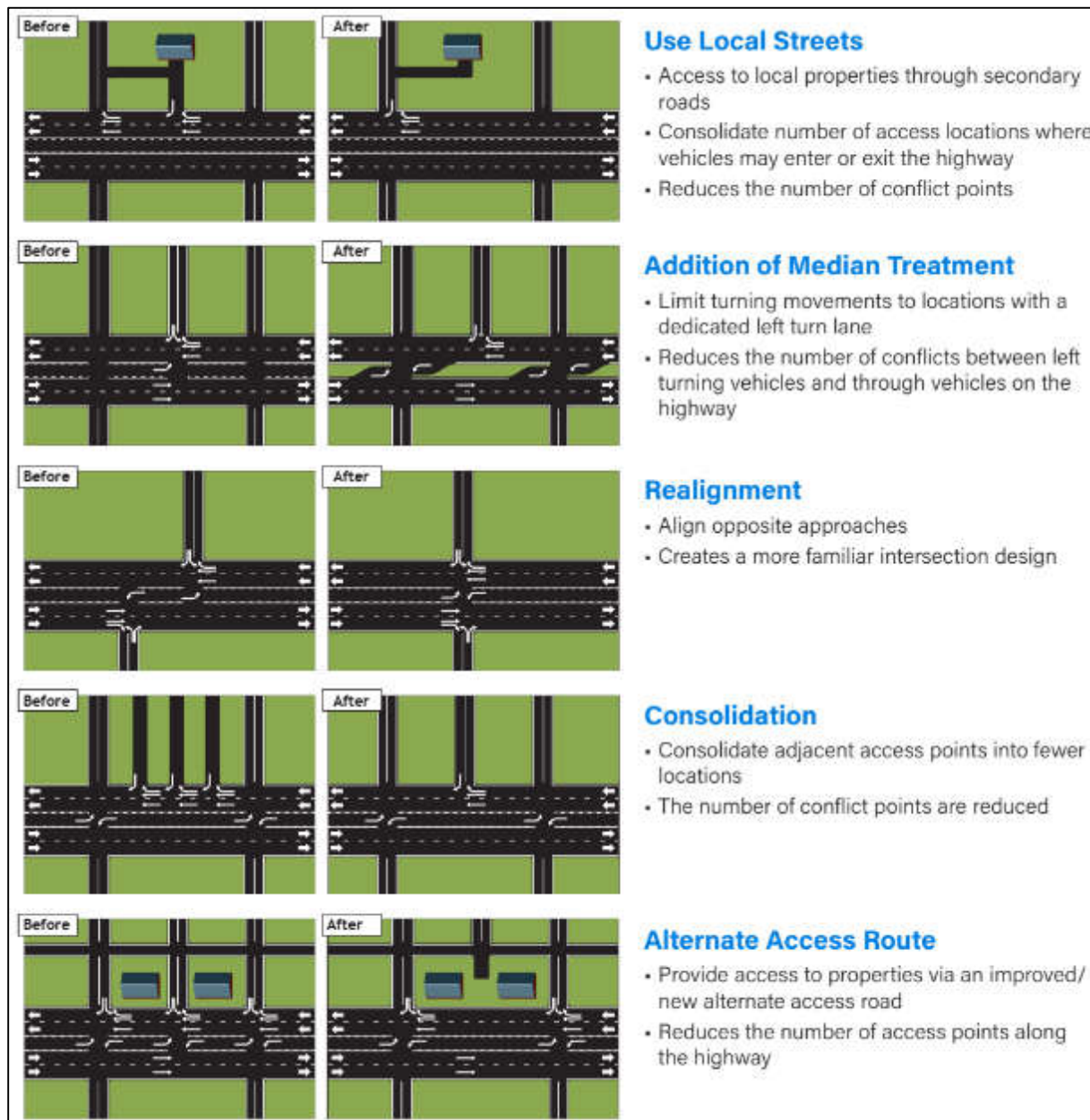

There are several areas along CO 83 where each of the access control methods can be applied. Local streets typically are used at locations where a property has one access point to CO 83 and an alternative access to a local street. To meet the objectives of an ACP to reduce the number of access points for safety and operational reasons, all properties adjacent to CO 83 should have their access to CO 83 closed where reasonable access to secondary roads is possible.

The purpose of access conversion through the use of median treatments is to eliminate some or all turning movements to reduce the number of conflicts between left-turning vehicles and through vehicles on the highway. By creating three-quarter movement accesses (left turns are allowed into the driveways, but not out of it) or RIRO movement accesses (no left turns in or out of the access), the number of conflicts will be reduced. The drivers wanting to turn left to/from these locations can use secondary roads to travel to adjacent improved intersections where left turns can be made, which are much safer than at unimproved locations. At other locations, the drivers can make right turns out of the approach roadways/driveways, travel to nearby improved intersections, and make a safe movement (U-turn or left turn).

Access realignment would either align opposite approaches to create a more familiar intersection design or move an existing access point to a new location. For example, some properties are situated close to existing or planned future roads and many of these properties currently have driveways with direct access to CO 83. As development occurs or as new roads are constructed, many of these direct connection driveways can be closed and moved to align with the new roads. This will create better spacing of intersections and reduce the number of conflict points.

Access consolidation is used to reduce the number of access points along the roadway. This approach typically is used at locations where adjacent property owners have individual driveways fairly close together. In these situations, the multiple driveways could be consolidated into a single point that is shared by adjacent properties to reduce conflicts, improve operations, and maintain adequate access to all properties. This approach is especially favorable for pedestrians/bicyclists traveling along the corridor on sidewalks because it reduces the number of conflict points with motor vehicles. While consolidation of access does provide benefits to the corridor, this approach may take years to accomplish because it typically requires redevelopment or site changes to the adjacent properties. If there are multiple property owners, then the process cannot be completed until all properties agree to the changes and/or redevelop their sites.

Lastly, alternate access routes provide access to properties via a new access road (such as a frontage road, backage road, or alleyways). In some cases, these alternative routes must be newly constructed or there may be a need to improve existing alternate routes to provide safe travel for the public. These improvements may include adding pavement, widening travel ways, and adding pedestrian facilities. This approach reduces the number of access points along the highway but provides alternate access to those properties from elsewhere.

5. Access Recommendations

Table 8, shows the total number of proposed accesses and segment lengths within each segment compared to the number of existing accesses. If the ACP were to be fully implemented, it would have the following changes to CO 83 access:

- The total number of access points would be reduced from 72 (7 accesses per mile) to 35 (4 access per mile), which is little more than a 50-percent reduction.
- New access locations that will allow for combining adjacent driveways and also better accommodate future development.
- The number of full-movement access points would be reduced from 71 to 30, which is about a 60-percent reduction and a spacing of signals (or roundabouts) to approximately ½-mile spacing.
- Average spacing between access points would increase from 0.13 miles per access to 0.28 miles per access.
- The number of conflict points within the study area would be significantly reduced resulting in a lower crash expectancy and a safer highway.
- Fewer vehicles turning onto/off of CO 83 would reduce congestion resulting in a better driving experience for residents, visitors, and those conducting business along CO 83.

Table 8. Proposed Accesses by Study Area Section

Section	Length (miles)	Existing Accesses				ACP Accesses					
		FM ¹	PM ²	Sig ³	Total	FM ¹	PM ²	Sig ³	New ⁴	Closed ⁵	Total ⁶
CO 21 to Old North Gate Rd	2.75	12	0	5	12	11	2	6	2	2	13
Old North Gate Rd to Hodgen Rd	5.00	46	1	2	47	8	2	4	3	23	10
Hodgen Rd to Palmer Divide Rd	2.10	13	0	1	13	11	1	6	5	22	12
Totals	9.85	71	1	8	72	30	5	16	10	47	35

1. FM means an access point that allows full movement (no turning restrictions).
2. PM means an access point that has some form of turn restrictions (three-quarter movement or RIRO).
3. SIG means an access that is controlled by a traffic signal or may be controlled by a signal in the future (note that one signalized access may include two access points directly across from one another).
4. New means the proposed locations that may allow access in the future.
5. Closed means the number of existing access points that are recommended for closure.
6. Total is the number of recommended FM plus PM access locations in a segment.

5.1. Roadway Sections and Access Descriptions

The recommended access points are shown in **Appendix A** contains a table with the actual ACP legal description for each access point, including the location by mile post, the proposed ultimate access configuration, and the conditions for change that must be satisfied before a change in access occurs. The development of the ACP does not represent a project and does not require implementation of any of the recommended changes. The ACP is a planning document that helps guide the City, County, and CDOT about changes to access on the corridor that may occur in the future. Typically, the recommended access changes will occur only when one of the following conditions occurs:

- A safety or operational issue is identified at the access location and a traffic study is completed to identify the best solution, which may include implementation of the recommendations in the ACP.
- A roadway improvement project (with identified funding) is completed, such as addition of medians, at which point the project also could implement recommendations in the ACP.
- If one or more properties redevelop, then the City, County, and CDOT would work with the property owners to implement the recommendations of the ACP.

The intent of this ACP study was not to identify design elements of each access location, such as number, length, and types of auxiliary lanes, but rather to focus on where each access should be located and what type of turns should be allowed at each location. The exact design elements for each access would be completed through a study conducted at the time of the final design for any access or roadway improvement project. Development is ongoing along the study roadway and may result in changes contained within this document occurring at any time in the future. The implementation of the plan is discussed in more detail below in Section 6.2, Plan Implementation.

The recommendations in this ACP are based on a final configuration of the study roadway, which may include the need to install median treatments. The following subsections provide a brief discussion on the proposed recommended changes to access along the study roadway. For more details regarding the conditions for changes in access along with a description of the existing, interim, and recommended access conditions, refer to the ACP table in **Appendix A**.

The same traffic volumes that were projected for the 2045 no-action conditions were used to evaluate the 2045 conditions with the recommended ACP. To ensure all traffic is accounted for, engineering judgement was used at the locations where access restrictions/closures were recommended to redistribute turning traffic back to CO 83 via side streets or adjacent access locations.

5.2. Level of Service Analysis

When the final proposed configuration for each access point was determined, another LOS analysis was conducted for the 2045 build scenario that used the recommendations for access location and turning movement restrictions in the proposed ACP. **Table 9** contains the intersection LOS and detailed analysis of the future LOS with the recommended access changes and the Synchro reports are provided in **Appendix C**. Intersections that are not currently signalized must meet the Federal Highway Administration (FHWA) *Manual on Uniform Traffic Control Devices* (MUTCD) traffic signal warrants prior to being signalized. All proposed intersection signalization should be determined by a future traffic study designed to obtain a minimum LOS D for the 20-year horizon.

The results of the analysis of the future LOS with the recommended ACP show the majority of intersections along CO 83 are projected to operate at a better LOS than if no ACP is implemented (no-action condition). With the ACP implemented, many of the intersections are proposed to be converted to a RIRO movement or three-quarter movement or to have a signal constructed to minimize the left-turn movements out from side streets onto the highway. Side street delay from vehicles trying to enter CO 83 is greatly reduced when turn restrictions are implemented.

Table 9. 2045 No-Action LOS Compared to 2045 LOS with ACP Implementation

Intersection	LOS/Delay (sec/veh)			
	No-Action (2045)		With ACP (2045)	
	AM	PM	AM	PM
Powers Blvd SB*	D/37	C/27	D/37	C/27
Powers Blvd NB*	C/30	C/25	C/30	C/25
CDOT Yard	B/15	D/32	B/15	B/14
Shoup Rd*	B/20	C/31	B/20	C/31
Flying Horse Club Dr/Abert Way*	C/24	C/21	C/24	C/21
North Gate Blvd*	D/40	C/30	D/40	C/30
Private Access (east of CO 83)	B/13	F/65	(CLOSED)	
Old North Gate Road	C/19	C/17	B/14*	A/10*
Old Lasso Point	F/77	F/103	B/12	B/12
Shamrock Ranch Rd	C/18	D/30	(CLOSED)	
Kaessner Lane	B/12	C/20	A/4*	A/4*
Stagecoach Rd	A/8	B/11	B/12*	B/13*
Private Access (west of CO 83)	C/18	D/30	(CLOSED)	
New ¾ movement Access	N/A		B/12	B/11
Benet Lane	C/17	C/24	(CLOSED)	
High Forest Rd	C/21	E/41	A/9*	A/9*
Arena Rd	C/17	C/19	(CLOSED)	
Hogden Rd*	D/38	E/62	D/38	E/62
New Signalized Access*	N/A		A/6*	A/7*
Walden Way	E/36	D/33	B/13*	A/10*
Walker Road/CR 105*	E/65	D/54	E/65	D/54
New Signalized Access*	N/A		B/11*	A/8*
New Signalized Access*	N/A		A/4*	A/5*
E Palmer Divide Ave*	C/23	C/25	C/23	C/25

Note: Blue = LOS A, Dark Green = LOS B, Light Green = LOS C, Orange = LOS D, Red = LOS E, Dark Red = LOS F.

* Signalized intersection.

5.3. Crash Analysis

Although future crashes cannot be accurately predicted, the recommendations of the ACP will have an impact on the overall safety of the study roadway by reducing the number of conflict points and providing better traffic control at intersections. Implementation of the ACP will significantly reduce the number of conflict points along the study roadway. The ACP makes recommendations that reduce the number of locations where paths of the different users cross each other. The following are examples of conflict point reductions:

- Conversion of access from full movement to RIRO movement
- Restriction of access from full movement to three-quarter movement
- Combining multiple access driveways into a single shared driveway

All of these examples eliminate conflict points along the roadways. By reducing the number of possible conflict points along a roadway, fewer crashes are expected to occur, resulting in a safer roadway. Pedestrians and bicyclists will have fewer intersections to cross and locations where they will not have to worry about left-turning vehicles.

The ACP also identifies several intersections that may require a change in traffic control, such as the installation of a traffic signal in the future. The changes in traffic control can have a positive impact on the overall safety of a roadway. While traffic signals may result in a higher number of rear-end crashes, they also provide an opportunity to reduce the number of left turn-related crashes by providing protection for left-turn movements. Traffic signals also provide a safer crossing opportunity for pedestrians/bicyclists as they will be able to cross the roadway with the protection of the signal.

The recommendations for changes to access along CO 83 should have an overall benefit to the safety of the study roadway in the future. Even as traffic volumes continue to increase, the reduction in conflict points and the introduction of better traffic control along the study roadway will have a positive impact on the overall safety for the different modes of transportation.

6. Next Steps

This document describes the process of developing the CO 83 ACP. There are several important steps that need to occur in the short term and long term to ensure that the City, County, and CO 83 users realize the maximum benefit of the recommendations from the ACP. These next steps start with the approval process.

6.1. Approval Process

Before the study roadways can begin to benefit from the recommendations of the ACP, a few important events must occur:

- IGA—All parties must agree to an IGA. (See **Appendix A** for a copy of the IGA.)
- Plan Approval—The ACP must be agreed to by City and County officials.
- Plan Adoption—The City and County must sign the IGA.
- Plan briefing to the State Transportation Commission.
- Approval by the State Access Manager at CDOT and signing of the IGA, which puts the plan into law.

After the ACP is officially adopted by the City, County, and CDOT, the adopted ACP becomes the basis for future decisions on site access. The CO 83 ACP, as identified in this document, does not have any implementation timing or schedule.

6.2. Plan Implementation

It is important to remember that the ACP is intended to represent a long-range plan for the study roadway. Implementation of the full plan will occur over the long term as a phased approach based on when:

- A safety need is identified
- New development or redevelopment occurs
- Funding for improvements is available
- Traffic needs arise

When intersections or access points have operational or safety concerns, the City, County, and CDOT will look for ways to address these issues. These projects most likely would incorporate portions of the ACP, such as implementing turn restrictions or improving adjacent intersections/access locations, to improve operations or increase safety along the corridor. **Figure 7** provides details about how the ACP may be implemented over time as a phased approach.

Implementation of the full plan at a single time is unlikely. This would be a publicly funded project by any combination of City, County, and CDOT. A future public project would include the access changes described in the ACP that could be implemented at the time of the project. With the implementation of a roadway improvement project the government would be responsible for making the access changes to the highway. Even with the planned project, the entire plan will not be implemented at one time because access must still be provided to each property on the corridor. For example, if a property has not been redeveloped, it might not be feasible to relocate the driveway or alternative access may not be available. In cases like this, an interim access to the property would be maintained until the proposed ultimate access configuration could be achieved. In many instances, the CO 83 ACP does identify the interim condition (such as converting a full movement access to RIRO in the interim until it can ultimately be closed as identified with a red 'X' in the ACP figures for recommended accesses within the study limits.

Figure 7. ACP Implementation Process

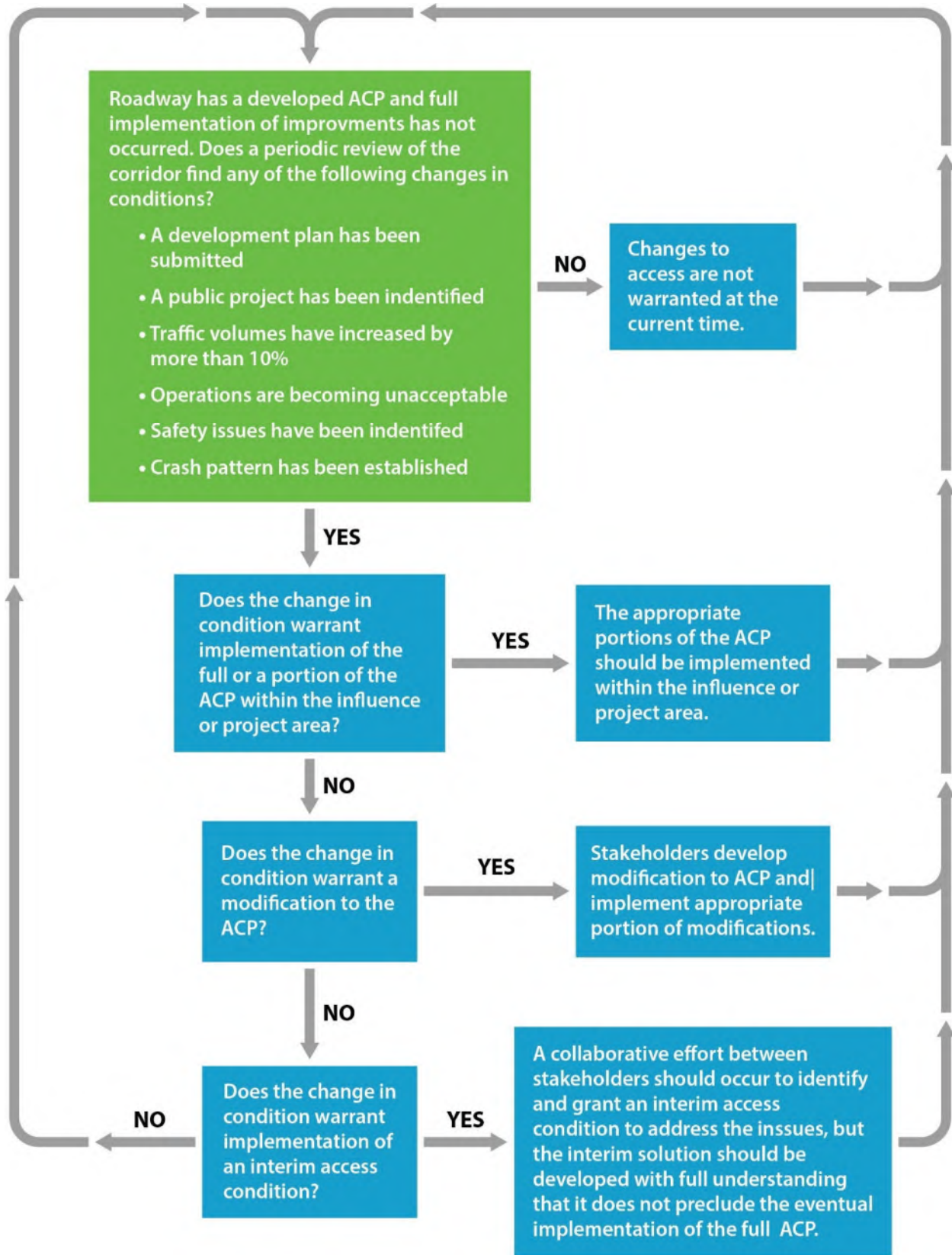

As traffic grows along CO 83, the City, County, and CDOT will be faced with deciding how to implement the ACP. One approach may be to implement interim roadway improvements that would delay the need to implement the proposed ultimate recommendations of the ACP. When intersections or access points have operational or safety concerns, the City, County, and CDOT will look for ways to address these issues. These projects most likely would incorporate portions of the ACP, such as implementing turn restrictions or improving adjacent intersections/access locations, to improve operations or increase safety along the corridor.

The most common trigger for the phased approach relates to when a property along CO 83 develops or redevelops, or if a driveway experiences a traffic volume increase of 20 percent or more (per the SHAC). Under this scenario, a new CDOT access permit is required, and the City, County, and CDOT would work with the property owner or the developer to make the access changes and highway improvements in the area directly impacted by the development/redevelopment. Coordination through the development process is critical to the final success of the plan. If the proposed ultimate recommendations of the ACP cannot be implemented when a property redevelops, the property should redevelop in such a way as to not prohibit the plan implementation. For example, new buildings should be constructed in such a manner as to use a future access location shown on the plan.

Even if project-related traffic volumes do not warrant the full implementation of the plan, the City and County should develop a method to collect funds from the owner/developer with the understanding that the changes will be necessary in the future. This may encourage some development to occur now, but the City and County will have collected funds to help offset the cost of the future improvements. This is especially important in the case where a property simply redevelops but does not increase the traffic generated by 20 percent or more. If the City and County do not implement the plan at the same time or collect funds for future implementation, it is unlikely the same property would redevelop again before the changes are necessary, creating a missed opportunity to implement the plan or collect contributions toward the improvements.

Another important aspect of the implementation process is how access is granted to new developments. Each property along the study roadway must be provided with reasonable access. The City, County, and CDOT should work with the owner/developer to ensure projects are designed with consideration to where access will be permitted in the proposed ACP. Access will be provided to the property as shown in the ACP unless it is not feasible to implement at the time of the development. Then, an interim access will be permitted, which will change when the proposed ultimate access conditions can be achieved. Coordinating with the owner/developer throughout the project development process will ensure the final design of the property does not preclude the implementation of the ACP's proposed ultimate access configuration along the study roadway.

6.3. Plan Modification

The outcome of this study is the ACP, which identifies the number, location, and type of access points that will be allowed on CO 83 within the study limits. Future changes to the plan are allowed based on the guidelines of the SHAC, according to Section 2.12, Access Control Plans:

The plan must receive the approval of both the Department and the appropriate local authority to become effective. This approval shall be in the form of a formal written agreement signed by the local authority and the Chief Engineer of the Department. After an access control plan is in effect, modifications to the plan must receive the approval of the local authority and the Department. Where an access control plan is in effect, all action taken in regard to access shall be in conformance with the plan and current Code design standards unless both the Department and the local authority approve a geometric design waiver under the waiver subsection of the Code (p. 30, paragraph 3).

This page intentionally left blank.

7. References

Federal Highway Administration (FHWA). (2009, updated 2012). *Manual on Uniform Traffic Control Devices*. Washington, DC: FHWA.

State Highway Access Category Assignment Schedule. (2003). 2 Code of Colorado Regulations (CCR) §601-1a. 30 October 2007.

State Highway Access Code. (1998). 2 Code of Colorado Regulations (CCR) §601-1. March 2002.

Transportation Research Board (TRB). (2010). *Highway Capacity Manual*. Washington, DC: National Academy of Sciences.

This page intentionally left blank.

Appendix A. ACP Legal Documents

A.1. IGA and Attachments

CO 83 Access Control Plan



Intergovernmental Agreement with Exhibits and Attachments

Intergovernmental Agreement
Colorado State Highway 83 (El Paso County)
Access Control Plan

This page left blank intentionally.

**INTERGOVERNMENTAL AGREEMENT
AMONG
THE CITY OF COLORADO SPRINGS, THE COUNTY OF EL PASO,
AND
THE STATE OF COLORADO
DEPARTMENT OF TRANSPORTATION**

THIS INTERGOVERNMENTAL AGREEMENT (hereinafter referred to as the "Agreement") is entered into effective as of the date defined below by and among the City of Colorado Springs, a home rule city and Colorado municipal corporation, (hereinafter referred to as the "City"), El Paso County, by and through the Board of County Commissioners of El Paso County, Colorado (hereinafter referred to as the "County") and the State of Colorado, Department of Transportation (hereinafter referred to as the "Department"), said parties being referred to collectively herein as the "Agencies."

RECITALS:

WHEREAS, the Agencies are authorized by the provisions of Article XIV, Section 18(2)(a), Colorado Constitution, and Sections 29-1-201, et. seq., C.R.S., to enter into contracts with each other for the performance of functions that they are authorized by law to perform on their own; and

WHEREAS, each Agency is authorized by Section 43-2-147(1)(a), C.R.S., to regulate access to public highways within its jurisdiction; and

WHEREAS, the coordinated regulation of vehicular access to public highways is necessary to maintain the efficient and smooth flow of traffic without compromising pedestrian and alternative modes of transportation circulation, to reduce the potential for traffic accidents, to protect the functional level and optimize the traffic capacity, to provide an efficient spacing of traffic signals, and to protect the public health, safety and welfare; and

WHEREAS, the Agencies desire to provide for the coordinated regulation of vehicular access for the section of Colorado State Highway 83 between the southbound CO 21 ramp (M.P. 20.4) and County Line Road (M.P. 30.2) (hereinafter referred to as the "Segment"), which is within the jurisdiction of the Agencies; and

WHEREAS, the Agencies desire to collaborate to assure all transportation modes including pedestrian, bicycle, vehicle, and mass transit are given sufficient consideration and adequate funding support with each transportation improvement project that affects access within the identified project limits; and

WHEREAS, the Agencies are authorized pursuant to Section 2.12 of the 2002 State Highway Access Code, 2 C.C.R. 601-1 (the "Access Code") to achieve such objective by written agreement among themselves adopting and implementing a comprehensive and mutually acceptable highway access control plan for the Segment for the purposes recited above; and

WHEREAS, the development of this Access Control Plan adheres to the requirements of the Access Code, Section 2.12.

NOW THEREFORE, for and in consideration of the mutual promises and undertakings herein contained, the Agencies agree as follows:

1. The Access Control Plan dated AUGUST 2021 for the Segment (hereinafter referred to as the "Access Control Plan") is attached hereto as Exhibit D and E, the Amendment Process is attached hereto as Exhibit B, and the Sample Amendment is attached hereto as Exhibit C, all of which are incorporated herein.

Intergovernmental Agreement
Colorado State Highway 83 (El Paso County)
Access Control Plan

2. The Agencies shall regulate access to the Segment in compliance with the Access Control Plan, the Highway Access Law, section 43-2-147, C.R.S., (the “Access Law”) and the applicable sections of the Access Code. Vehicular access to the Segment shall be permitted when such access is in compliance with the Access Control Plan, the Access Law and the applicable sections of the Access Code, which the County has adopted by reference.
3. Accesses that were in existence in compliance with the Access Law prior to the effective date of this Agreement may continue in existence until such time as a change in the access is required by the Access Control Plan or in the course of highway reconstruction. Changes to access including but not limited to consolidating access points consistent with the Access Control Plan will be made in the course of development or subdivisions by the City and/or County or when alternative access is provided with new or improved City and/or County roads. When closure, modification, or relocation of access is necessary or required, the Agency(ies) having jurisdiction shall utilize appropriate legal process to affect such action.
4. Actions taken by any Agency with regard to transportation planning, transportation facilities, and traffic operations within the areas described in the Access Control Plan shall be in conformity with this Agreement. Per Section 2.12 (3) of the Access Code, design waivers may be approved if agreed upon by the Agencies having jurisdiction. The City and County agree to develop and adopt further the necessary resolutions, ordinance, official documents, plans and maps that are necessary to fulfill their responsibilities under this agreement.
5. Parcels of real property created after the effective date of this Agreement that adjoin the Segment shall not be provided with direct access to the Segment unless the location, use and design thereof conform to the provisions of this Agreement.
6. This Agreement supersedes and controls all prior written and oral agreements and representations of the Agencies and constitutes the whole agreement between them with respect to regulating vehicular access to the Segment. No additional or different oral representation, promise, or agreement shall be binding on an Agency. This Agreement may be amended or terminated only in writing executed by the Agencies with express authorization from their respective governing bodies or legally designated officials. Upon thirty-days’ notice, any party to this Agreement may withdraw from the Agreement in writing, without consent of the other parties. To the extent the Access Control Plan, attached as Exhibit D and E to this Agreement, is modified by a change, closure, relocation, consolidation or addition of an access, the Agencies may amend the attached Exhibit D and E so long as the amendment to the Access Control Plan is executed in writing and amended in accord with the Access Law and Access Code. The Access Control Plan Amendment Process has been included in Exhibit B. This Agreement is based upon and is intended to be consistent with the Access Law and the Access Code as now or hereafter constituted. An amendment to either the Access Law or the Access Code that becomes effective after the effective date of this Agreement and that conflicts irreconcilably with an express provision of this Agreement may be grounds for revision of this Agreement.
7. This Agreement does not create any current financial obligation for any Agency. Any future financial obligation of any Agency shall be subject to the execution of an appropriate encumbrance document, where required. Agencies involved in or affected by any particular or site-specific undertaking provided for herein will cooperate with each other to agree upon a fair and equitable allocation of the costs associated therewith; however, notwithstanding any provision of this Agreement, no Agency shall be required to expend its public funds for such undertaking without the express prior approval of its governing body, director, and if required, state controller. All financial obligations of the Agencies hereunder shall be contingent upon sufficient funds therefore being appropriated, budgeted, and otherwise made available as provided by law.

Intergovernmental Agreement
Colorado State Highway 83 (El Paso County)
Access Control Plan

8. Should any one or more sections or provisions of this Agreement be judicially determined to be invalid or unenforceable, such judgment shall not affect, impair or invalidate the remaining provisions of this Agreement, the intention being that the various provisions hereof are severable.
9. By signing this Agreement, the Agencies acknowledge and represent to one another that all procedures necessary to validly contract and execute this Agreement have been performed, and that the persons signing for each Agency have been duly authorized by such Agency to do so.
10. No portion of this Agreement shall be deemed to constitute a waiver, express or implied, of any of the immunities, rights, benefits, protections or other provisions of the Colorado Governmental Immunity Act, C.R.S. Section 24-10-101, et. seq., nor shall any portion of this Agreement be deemed to have created a duty of care that did not previously exist with respect to any person not a party to this Agreement.
11. It is expressly understood and agreed that the enforcement of the terms and conditions of this Agreement, and all rights of action relating to such enforcement, shall be strictly reserved to the undersigned parties and nothing in this Agreement shall give or allow any claim or right of action whatsoever by any other person not a party to this Agreement. It is the express intention of the undersigned parties that any entity other than the undersigned parties receiving services or benefits under this Agreement shall be an incidental beneficiary only.
12. This Agreement may be executed in counterparts, each of which shall be deemed an original and all of which together shall constitute one original Agreement. Facsimile signature shall be as effective as an original signature.
13. Effective Date. The Effective Date of this Agreement shall be the date of the last party to sign.

IN WITNESS WHEREOF, the Agencies have executed this Agreement effective as of the day and year of the of last party to sign below.

City of Colorado Springs, Colorado

ATTEST:

Mayor, City of Colorado Springs Date

City Clerk Date

APPROVED AS TO FORM:

City Attorney's Office Date

Intergovernmental Agreement
Colorado State Highway 83 (El Paso County)
Access Control Plan

**Board of County Commissioners
Of El Paso County, Colorado**

ATTEST:

Chair Date

County Clerk & Recorder Date

APPROVED AS TO FORM:

County Attorney's Office Date

**State of Colorado
Department of Transportation**

Region 2 Regional Transportation Date
Director

CONCUR:

Statewide Access Program Date
Administrator

“EXHIBIT – A”
COLORADO STATE HIGHWAY 83
(CO 83 MP 20.4-MP 30.2)
ACCESS CONTROL PLAN
AMONG THE CITY OF COLORADO SPRINGS,
EL PASO COUNTY,
AND THE STATE OF COLORADO
DEPARTMENT OF TRANSPORTATION
AUGUST 2021

I. PURPOSE

The purpose of this Access Control Plan (ACP) is to provide the Agencies with a comprehensive roadway access control plan for the pertinent segment of Colorado State Highway 83 between the southbound CO 21 ramp (M.P. 20.4) and County Line Road (M.P. 30.2).

II. AUTHORITY

The development of this Access Control Plan was completed pursuant to the requirements of the Access Code, Section 2.12, and adopted by the attached Agreement.

III. RESPONSIBILITIES

It is the responsibility of each of the Agencies to this Agreement to ensure that vehicular access to the Segment shall only be in conformance with this Agreement. The cost of access improvements, closures and modifications shall be determined pursuant to section 43-2-147(6) C.R.S., the Agreement, and this Access Control Plan. All access construction shall be consistent with the design criteria and specifications of the Access Code.

IV. EXISTING AND FUTURE ACCESS

- A. The attached table provides a listing of each existing and future access point in the Segment. For each access point the following information is provided: location, description of the current access status, the future configuration (Access Plan), and the condition(s) for change. All access points along Colorado State Highway 83 are defined by the approximate Department reference point (in hundredths of a mile) based on CDOT Highway Segment Description Mileposts. All access points are located at the approximate centerline of the access (+/- 50 feet) unless otherwise noted in the Access Control Plan and associated tables. Exhibits graphically illustrating the Access Plan are attached for reference. In case of discrepancy, the Access Control Plan Table takes precedence.

- B. All highway design and construction will be based on the assumption that the Segment will have a sufficient cross section to accommodate all travel lanes and sufficient right-of-way to accommodate longitudinal installation of utilities.

V. ACCESS MODIFICATION

Any proposed access modification including but not limited to an addition must be in compliance with this Agreement and the current Access Code design standards unless the Agency or Agencies having jurisdiction approves a design waiver under the waiver subsection of the Code.

The Agencies may close, relocate, or consolidate any access described in this section restrict turning movements for an access, or bring an access into conformance with this ACP, provide the requirements of the ACP Amendment Process are met and any of the following conditions occur:

- a. The access is determined to be detrimental to the public’s health, safety or welfare;
- b. the access has developed an accident history that in the opinion of the Agency(ies) having jurisdiction or the Department is correctable by restricting the access;

Exhibit A
Colorado State Highway 83 (El Paso County)
Access Control Plan

- c. the access restrictions are necessitated by a change in road or traffic conditions;
- d. there is an approved (by the Agency having jurisdiction) change in the use of the property that would result in a change in the type of access operation as defined by the Access Code;
- e. a highway reconstruction project provides the opportunity to make highway and access improvements in support of this Access Control Plan; or
- f. the existing development does not allow for the proposed street and road network.

Access construction shall be consistent with the design and specifications of the current State Highway Access Code.

“EXHIBIT - B”
COLORADO STATE HIGHWAY 83
(CO 83 MP 20.4-MP 30.2)
ACCESS CONTROL PLAN
AMENDMENT PROCESS
AMONG THE CITY OF COLORADO SPRINGS,
EL PASO COUNTY,
AND THE STATE OF COLORADO
DEPARTMENT OF TRANSPORTATION

1. A request for an amendment of the Access Control Plan must be initiated by one of the Agencies. The initiating Agency will be responsible for the costs associated with completing and documenting the Amendment.
2. Amendment requests must be submitted to and agreed upon by the affected jurisdictions: Department staff, County staff, and City staff of the Intergovernmental Agreement, depending on the property location. The property or properties that are directly affected by the proposed amendment must be located within a jurisdiction’s boundaries or within the boundaries of a legally recognized planning area, such as a Growth Management Area, for the jurisdiction to be considered an affected jurisdiction.
3. An amendment request shall include hard copy and electronic files of the following:
 - a) Description of changes to the Access Control Plan requested
 - b) Justification for the Amendment
 - c) Traffic Impact Study or analysis, depending upon the magnitude of the change requested. Any affected jurisdiction of the Intergovernmental Agreement can request this supporting documentation.
 - d) Amended Access Control Plan Table
 - e) Amended Access Control Plan Exhibit(s)/Map(s)
4. The Agencies shall review the submittal concurrently for completeness and for consistency with the access objectives, principles, and strategies described in the *Colorado State Highway 83 Access Control Plan* (AUGUST 2021) executive summary and Appendix for this corridor and with the design criteria and permit process of the State Highway Access Code.
5. Prior to approval of an amendment, all property owners directly affected by the amendment must be notified in writing and be given thirty (30) calendar days to state any objections. If an objection is lodged, approval of the amendment must be referred to the Agencies respective governing bodies. Depending on the magnitude of the change requested, a public meeting may be required. Any affected jurisdiction of the Intergovernmental Agreement can request a public meeting. The Agency initiating the amendment request shall be responsible for all public notification and public process, unless otherwise agreed to by the Agencies.
6. Amendments must be approved in writing by the following authorized designated officials: Regional Transportation Director for the Department, the City Manager and/or County Administrator. At the authorized designated official’s discretion, approval may be referred to their respective governing bodies: Chief Engineer for the Department and local elected officials for the City and County.
7. A written amendment must include the following:
 - a) Declarations page defining the parties, effective date, and details of the amendment. Refer to sample amendment attached to this Exhibit as Exhibit C.

Exhibit B
Colorado State Highway 83 (El Paso County)
Access Control Plan Amendment Process

- b) Signatures page for authorized designated officials. Refer to Exhibit C.
- c) Amended Access Control Plan table and exhibits. Table and exhibits should be replaced in their entirety.

A signed amendment must be attached to the original Intergovernmental Agreement.

8. If all affected jurisdictions of the Intergovernmental Agreement do not come to agreement on a proposed amendment, the content of the original Access Control Plan remains intact.

**“EXHIBIT – C”
 SAMPLE AMENDMENT TO
 INTERGOVERNMENTAL AGREEMENT
 AMONG THE CITY OF COLORADO SPRINGS,
 EL PASO COUNTY,
 AND THE STATE OF COLORADO
 DEPARTMENT OF TRANSPORTATION
 AUGUST 2021**

WHEREAS:

The City of Colorado Springs, El Paso County (hereinafter referred to as the “City and County”) and the State of Colorado, Department of Transportation (hereinafter referred to as the “Department”), said parties being referred to collectively herein as the “Agencies”, entered into an Agreement in AUGUST 2021 to adopt an Access Control Plan dated AUGUST 2021 for the section of Colorado State Highway 83 between the southbound CO 21 ramp (M.P. 20.4) and County Line Road (M.P. 30.2) (hereinafter referred to as the "Segment").

The Agencies desire to amend this Agreement in accordance with the attached table for the Segment.

NOW, THEREFORE, the Agencies do hereby agree:

The Agreement and the terms and conditions therein shall remain unchanged other than those sections and exhibits listed below:

The attached table and exhibits for Colorado State Highway 83 in Exhibit D and E shall be replaced with the table attached to this Amendment.

IN WITNESS WHEREOF, the parties hereto have executed this Amendment as of the day and year written above:

City of Colorado Springs, Colorado

 City Mayor Date

El Paso County , Colorado

 County Administrator Date

State of Colorado, Department of Transportation

 Regional Transportation Director Date

Exhibit C
Colorado State Highway 83 (El Paso County)
Access Control Plan Amendment Process

This page left blank intentionally.

CO 83 Access Control Plan



Exhibit D

Access Description Table

AUGUST 2021

This page left blank intentionally.

Exhibit - D Access Control Plan Table^{1,2}

Colorado State Highway 83 (El Paso County)

August 2021

Access # (Map #)	Milepost ³	Side of Road	Access Description	Existing Land Use	Existing Configuration	Ultimate Configuration	Notes/Conditions for Change ⁴
1 (1)	20.379	East	Southbound CO 21 Ramp	Transportation (Public Roadway)	Full movement (signalized)	Full Movement⁵	Access design may be changed to better accommodate U-turns if Access #4 is restricted to less than full movement.
73 (1)	20.382	West	New Access	N/A	N/A	Full Movement⁵	Add missing intersection leg as part of transportation network improvements.
2 (1)	20.545	East	Northbound CO 21 Ramp	Transportation (Public Roadway)	Full movement (signalized)	Full Movement⁵	None
74 (1)	20.547	West	New Access	N/A	N/A	Full Movement⁵	Add missing intersection leg as part of transportation network improvements.
3 (1)	20.688	East	Private Driveway	Open Field	Full movement (un-signalized)	3/4 Movement⁶	Access may be restricted to less than full movement if: <ul style="list-style-type: none"> • Adequate improvements have been made to ensure U-turns can be safely completed at nearby intersections, and • Operational and/or safety issues are identified through the completion of a traffic study; or • A cross access easement is obtained with adjacent property(ies); and internal connectivity to/from Access #6 is developed; or • A traffic signal is warranted.

1. The current State Highway Access Code shall govern any unresolved discrepancies regarding access decisions.

2. All access points are subject to consolidation upon the combining or subdividing of any lots under a single ownership or controlling interest.

3. All access locations +/- 50 feet (0.01 mile) unless otherwise noted.

4. The type, number, and storage length of lanes may be determined by a separate traffic study to be completed at the time of the actual design and implementation of the access plan and to ensure that the design does not create operational and/or safety issues.

5. Full movement access with potential to become/remain signalized or change to other full movement control, such as a roundabout. The design of any intermediate/final intersection control changes will be completed under a separate study to ensure that the design complies with the recommendations of the access control plan and does not create operational and/or safety issues.

6. A 3/4 movement configuration means that vehicles can turn right into the access, turn right out of the access, and turn left into the access.

Exhibit - D Access Control Plan Table^{1,2}

Colorado State Highway 83 (El Paso County)

August 2021

Access # (Map #)	Milepost ³	Side of Road	Access Description	Existing Land Use	Existing Configuration	Ultimate Configuration	Notes/Conditions for Change ⁴
4 (1)	20.688	West	Unnamed Public Roadway	Civic (CDOT)	Full movement (un-signalized)	3/4 Movement⁶	Access may be restricted to less than full movement if: <ul style="list-style-type: none"> • Adequate improvements have been made to ensure U-turns can be safely completed at nearby intersections, and • Operational and/or safety issues are identified through the completion of a traffic study; or • A traffic signal is warranted.
Milepost 21							
5 (1)	21.148	West	Old CO 83	Transportation (old road)	Closed	Closed.	None.
6 (2)	21.241	East	Shoup Road	Transportation (Public Roadway)	Full movement (signalized)	Full Movement⁵	Access design may be changed to better accommodate U-turns if Access #3 is restricted to less than full movement.
Milepost 22							
7 (3)	22.100	East	Abert Way	Transportation (Public Roadway)	Full movement (signalized)	Full Movement⁵	None.
8 (3)	22.100	West	Flying Horse Club Drive	Transportation (Public Roadway)	Full movement (signalized)	Full Movement⁵	None.
9 (4)	22.646	East	Private Driveway	Rural Residential	Full movement (signalized)	Full Movement⁵	Access design may be changed to better accommodate U-turns if Access #11 is restricted to less than full movement.
10 (4)	22.646	West	North Gate Boulevard	Transportation (Public Roadway)	Full movement (signalized)	Full Movement⁵	Access design may be changed to better accommodate U-turns if Access #11 is restricted to less than full movement.

1. The current State Highway Access Code shall govern any unresolved discrepancies regarding access decisions.

2. All access points are subject to consolidation upon the combining or subdividing of any lots under a single ownership or controlling interest.

3. All access locations +/- 50 feet (0.01 mile) unless otherwise noted.

4. The type, number, and storage length of lanes may be determined by a separate traffic study to be completed at the time of the actual design and implementation of the access plan and to ensure that the design does not create operational and/or safety issues.

5. Full movement access with potential to become/remains signalized or change to other full movement control, such as a roundabout. The design of any intermediate/final intersection control changes will be completed under a separate study to ensure that the design complies with the recommendations of the access control plan and does not create operational and/or safety issues.

6. A 3/4 movement configuration means that vehicles can turn right into the access, turn right out of the access, and turn left into the access.

Exhibit - D Access Control Plan Table^{1,2}

Colorado State Highway 83 (El Paso County)

August 2021

Access # (Map #)	Milepost ³	Side of Road	Access Description	Existing Land Use	Existing Configuration	Ultimate Configuration	Notes/Conditions for Change ⁴
11 (4)	22.946	East	Private Driveway	Rural Residential	Full movement (un-signalized)	Closed	<p>Access may be restricted to right-in, right-out or ¾ movement if:</p> <ul style="list-style-type: none"> • Adequate improvements have been made to ensure U-turns can be safely completed at nearby intersections, and • The adjacent property(ies) redevelops; or • An operational and/or safety issues are identified through the completion of a traffic study, or • As part of roadway improvement project that adds capacity or a median to CO 83. <p>Access will be closed if:</p> <ul style="list-style-type: none"> • A cross access easement is obtained with adjacent property(ies); and • Internal connectivity to/from Access #9 or Access #13 is developed.
Milepost 23							
12 (4)	23.124	West	Old North Gate Road	Transportation (Public Roadway)	Full movement (un-signalized)	Full Movement⁵	Access design may be changed to better accommodate U-turns if nearby accesses are restricted to less than full movement.
13 (4)	23.131	East	Private Driveway	Rural Residential	Full movement (un-signalized)	Full Movement⁵	Access design may be changed to better accommodate U-turns if nearby accesses are restricted to less than full movement.

1. The current State Highway Access Code shall govern any unresolved discrepancies regarding access decisions.

2. All access points are subject to consolidation upon the combining or subdividing of any lots under a single ownership or controlling interest.

3. All access locations +/- 50 feet (0.01 mile) unless otherwise noted.

4. The type, number, and storage length of lanes may be determined by a separate traffic study to be completed at the time of the actual design and implementation of the access plan and to ensure that the design does not create operational and/or safety issues.

5. Full movement access with potential to become/remain signalized or change to other full movement control, such as a roundabout. The design of any intermediate/final intersection control changes will be completed under a separate study to ensure that the design complies with the recommendations of the access control plan and does not create operational and/or safety issues.

6. A 3/4 movement configuration means that vehicles can turn right into the access, turn right out of the access, and turn left into the access.

Exhibit - D
Access Control Plan Table^{1,2}

Colorado State Highway 83 (El Paso County)

August 2021

Access # (Map #)	Milepost ³	Side of Road	Access Description	Existing Land Use	Existing Configuration	Ultimate Configuration	Notes/Conditions for Change ⁴
14 (5)	23.321	West	Rustic Oak Grove (Private Driveway)	Rural Residential	Full movement (un-signalized)	Closed	<p>Access may be restricted to right-in, right-out or ¾ movement if:</p> <ul style="list-style-type: none"> • Adequate improvements have been made to ensure U-turns can be safely completed at nearby intersections, and • An operational and/or safety issues are identified through the completion of a traffic study; or • The adjacent property redevelops, or • As part of roadway improvement project that adds capacity or a median to CO 83. <p>Access will be closed if:</p> <ul style="list-style-type: none"> • A cross access easement(s) is obtained with adjacent property(ies); and • Internal connectivity to/from Old North Gate Road (Access #12) or Old Lasso Point (Access #16) is developed.

1. The current State Highway Access Code shall govern any unresolved discrepancies regarding access decisions.
2. All access points are subject to consolidation upon the combining or subdividing of any lots under a single ownership or controlling interest.
3. All access locations +/- 50 feet (0.01 mile) unless otherwise noted.
4. The type, number, and storage length of lanes may be determined by a separate traffic study to be completed at the time of the actual design and implementation of the access plan and to ensure that the design does not create operational and/or safety issues.
5. Full movement access with potential to become/remain signalized or change to other full movement control, such as a roundabout. The design of any intermediate/final intersection control changes will be completed under a separate study to ensure that the design complies with the recommendations of the access control plan and does not create operational and/or safety issues.
6. A 3/4 movement configuration means that vehicles can turn right into the access, turn right out of the access, and turn left into the access.

Exhibit - D Access Control Plan Table^{1,2}

Colorado State Highway 83 (El Paso County)

August 2021

Access # (Map #)	Milepost ³	Side of Road	Access Description	Existing Land Use	Existing Configuration	Ultimate Configuration	Notes/Conditions for Change ⁴
15 (5)	23.355	West	Private Driveway	Rural Residential	Full movement (un-signalized)	Closed	<p>Access may be restricted to right-in, right-out or ¾ movement if:</p> <ul style="list-style-type: none"> • Adequate improvements have been made to ensure U-turns can be safely completed at nearby intersections, and • An operational and/or safety issues are identified through the completion of a traffic study; or • The adjacent property redevelops, or • As part of roadway improvement project that adds capacity or a median to CO 83. <p>Access will be closed if:</p> <ul style="list-style-type: none"> • A cross access easement(s) is obtained with adjacent property(ies); and • Internal connectivity to/from Old North Gate Road (Access #12) or Old Lasso Point (Access #16) is developed.

1. The current State Highway Access Code shall govern any unresolved discrepancies regarding access decisions.

2. All access points are subject to consolidation upon the combining or subdividing of any lots under a single ownership or controlling interest.

3. All access locations +/- 50 feet (0.01 mile) unless otherwise noted.

4. The type, number, and storage length of lanes may be determined by a separate traffic study to be completed at the time of the actual design and implementation of the access plan and to ensure that the design does not create operational and/or safety issues.

5. Full movement access with potential to become/remain signalized or change to other full movement control, such as a roundabout. The design of any intermediate/final intersection control changes will be completed under a separate study to ensure that the design complies with the recommendations of the access control plan and does not create operational and/or safety issues.

6. A 3/4 movement configuration means that vehicles can turn right into the access, turn right out of the access, and turn left into the access.

Exhibit - D
Access Control Plan Table^{1,2}

Colorado State Highway 83 (El Paso County)

August 2021

Access # (Map #)	Milepost ³	Side of Road	Access Description	Existing Land Use	Existing Configuration	Ultimate Configuration	Notes/Conditions for Change ⁴
16 (5)	23.428	West	Old Lasso Point (Private Driveway)	Rural Residential	Full movement (un-signalized)	Right-in, Right-out	<p>Access may be restricted to less than full movement if:</p> <ul style="list-style-type: none"> • Adequate improvements have been made to ensure U-turns can be safely completed at nearby intersections, and • As part of roadway improvement project that adds capacity or a median to CO 83; or • The adjacent property redevelops; or • A cross access easement is obtained with adjacent property; and internal connectivity to/from Old North Gate Road (Access #12) is developed, or • Operational and/or safety issues are identified through the completion of a traffic study; or • A traffic signal is warranted.

1. The current State Highway Access Code shall govern any unresolved discrepancies regarding access decisions.

2. All access points are subject to consolidation upon the combining or subdividing of any lots under a single ownership or controlling interest.

3. All access locations +/- 50 feet (0.01 mile) unless otherwise noted.

4. The type, number, and storage length of lanes may be determined by a separate traffic study to be completed at the time of the actual design and implementation of the access plan and to ensure that the design does not create operational and/or safety issues.

5. Full movement access with potential to become/remains signalized or change to other full movement control, such as a roundabout. The design of any intermediate/final intersection control changes will be completed under a separate study to ensure that the design complies with the recommendations of the access control plan and does not create operational and/or safety issues.

6. A 3/4 movement configuration means that vehicles can turn right into the access, turn right out of the access, and turn left into the access.

Exhibit - D
Access Control Plan Table^{1,2}

Colorado State Highway 83 (El Paso County)

August 2021

Access # (Map #)	Milepost ³	Side of Road	Access Description	Existing Land Use	Existing Configuration	Ultimate Configuration	Notes/Conditions for Change ⁴
17 (5)	23.459	East	Private Driveway	Rural Residential	Full movement (un-signalized)	Closed	<p>Access may be restricted to right-in, right-out or $\frac{3}{4}$ movement if:</p> <ul style="list-style-type: none"> • Adequate improvements have been made to ensure U-turns can be safely completed at nearby intersections, and • An operational and/or safety issues are identified through the completion of a traffic study; or • The adjacent property redevelops, or • As part of roadway improvement project that adds capacity or a median to CO 83. <p>Access will be closed if:</p> <ul style="list-style-type: none"> • A cross access easement(s) is obtained with adjacent property(ies); and • Internal connectivity to/from Access #13 or New Access #75 is developed.

1. The current State Highway Access Code shall govern any unresolved discrepancies regarding access decisions.
2. All access points are subject to consolidation upon the combining or subdividing of any lots under a single ownership or controlling interest.
3. All access locations +/- 50 feet (0.01 mile) unless otherwise noted.
4. The type, number, and storage length of lanes may be determined by a separate traffic study to be completed at the time of the actual design and implementation of the access plan and to ensure that the design does not create operational and/or safety issues.
5. Full movement access with potential to become/remain signalized or change to other full movement control, such as a roundabout. The design of any intermediate/final intersection control changes will be completed under a separate study to ensure that the design complies with the recommendations of the access control plan and does not create operational and/or safety issues.
6. A $\frac{3}{4}$ movement configuration means that vehicles can turn right into the access, turn right out of the access, and turn left into the access.

Exhibit - D Access Control Plan Table^{1,2}

Colorado State Highway 83 (El Paso County)

August 2021

Access # (Map #)	Milepost ³	Side of Road	Access Description	Existing Land Use	Existing Configuration	Ultimate Configuration	Notes/Conditions for Change ⁴
18 (5)	23.459	West	Private Driveway	Rural Residential	Full movement (un-signalized)	Closed	<p>Access may be restricted to right-in, right-out or $\frac{3}{4}$ movement if:</p> <ul style="list-style-type: none"> • Adequate improvements have been made to ensure U-turns can be safely completed at nearby intersections, and • An operational and/or safety issues are identified through the completion of a traffic study; or • The adjacent property redevelops, or • As part of roadway improvement project that adds capacity or a median to CO 83. <p>Access will be closed if:</p> <ul style="list-style-type: none"> • A cross access easement(s) is obtained with adjacent property(ies); and • Internal connectivity to/from Old Lasso Point (Access #16) is developed.

1. The current State Highway Access Code shall govern any unresolved discrepancies regarding access decisions.

2. All access points are subject to consolidation upon the combining or subdividing of any lots under a single ownership or controlling interest.

3. All access locations +/- 50 feet (0.01 mile) unless otherwise noted.

4. The type, number, and storage length of lanes may be determined by a separate traffic study to be completed at the time of the actual design and implementation of the access plan and to ensure that the design does not create operational and/or safety issues.

5. Full movement access with potential to become/remain signalized or change to other full movement control, such as a roundabout. The design of any intermediate/final intersection control changes will be completed under a separate study to ensure that the design complies with the recommendations of the access control plan and does not create operational and/or safety issues.

6. A $\frac{3}{4}$ movement configuration means that vehicles can turn right into the access, turn right out of the access, and turn left into the access.

Exhibit - D Access Control Plan Table^{1,2}

Colorado State Highway 83 (El Paso County)

August 2021

Access # (Map #)	Milepost ³	Side of Road	Access Description	Existing Land Use	Existing Configuration	Ultimate Configuration	Notes/Conditions for Change ⁴
19 (5)	23.560	West	Private Driveway	Rural Residential	Full movement (un-signalized)	Closed	<p>Access may be restricted to right-in, right-out or ¾ movement if:</p> <ul style="list-style-type: none"> • Adequate improvements have been made to ensure U-turns can be safely completed at nearby intersections, and • An operational and/or safety issues are identified through the completion of a traffic study; or • The adjacent property redevelops, or • As part of roadway improvement project that adds capacity or a median to CO 83. <p>Access will be closed if:</p> <ul style="list-style-type: none"> • A cross access easement(s) is obtained with adjacent property(ies); and • Internal connectivity to/from Old Lasso Point (Access #16) or Kaessner Lane (Access #25) is developed.

1. The current State Highway Access Code shall govern any unresolved discrepancies regarding access decisions.

2. All access points are subject to consolidation upon the combining or subdividing of any lots under a single ownership or controlling interest.

3. All access locations +/- 50 feet (0.01 mile) unless otherwise noted.

4. The type, number, and storage length of lanes may be determined by a separate traffic study to be completed at the time of the actual design and implementation of the access plan and to ensure that the design does not create operational and/or safety issues.

5. Full movement access with potential to become/remain signalized or change to other full movement control, such as a roundabout. The design of any intermediate/final intersection control changes will be completed under a separate study to ensure that the design complies with the recommendations of the access control plan and does not create operational and/or safety issues.

6. A 3/4 movement configuration means that vehicles can turn right into the access, turn right out of the access, and turn left into the access.

Exhibit - D Access Control Plan Table^{1,2}

Colorado State Highway 83 (El Paso County)

August 2021

Access # (Map #)	Milepost ³	Side of Road	Access Description	Existing Land Use	Existing Configuration	Ultimate Configuration	Notes/Conditions for Change ⁴
20 (5)	23.625	East	Shamrock Ranch Road (Private Driveway)	Rural Residential	Full movement (un-signalized)	Closed	<p>Access may be restricted to right-in, right-out or ¾ movement if:</p> <ul style="list-style-type: none"> • Adequate improvements have been made to ensure U-turns can be safely completed at nearby intersections, and • An operational and/or safety issues are identified through the completion of a traffic study; or • The adjacent property redevelops, or • As part of roadway improvement project that adds capacity or a median to CO 83; or • A traffic signal is warranted. <p>Access will be closed if:</p> <ul style="list-style-type: none"> • Internal connectivity to/from New Access #75 is developed; or • A cross access easement is obtained with adjacent property; and internal connectivity to/from Access #13 is developed.

1. The current State Highway Access Code shall govern any unresolved discrepancies regarding access decisions.

2. All access points are subject to consolidation upon the combining or subdividing of any lots under a single ownership or controlling interest.

3. All access locations +/- 50 feet (0.01 mile) unless otherwise noted.

4. The type, number, and storage length of lanes may be determined by a separate traffic study to be completed at the time of the actual design and implementation of the access plan and to ensure that the design does not create operational and/or safety issues.

5. Full movement access with potential to become/remain signalized or change to other full movement control, such as a roundabout. The design of any intermediate/final intersection control changes will be completed under a separate study to ensure that the design complies with the recommendations of the access control plan and does not create operational and/or safety issues.

6. A 3/4 movement configuration means that vehicles can turn right into the access, turn right out of the access, and turn left into the access.

Exhibit - D Access Control Plan Table^{1,2}

Colorado State Highway 83 (El Paso County)

August 2021

Access # (Map #)	Milepost ³	Side of Road	Access Description	Existing Land Use	Existing Configuration	Ultimate Configuration	Notes/Conditions for Change ⁴
21 (5)	23.699	West	Private Driveway	Rural Residential	Full movement (un-signalized)	Closed	<p>Access may be restricted to right-in, right-out or $\frac{3}{4}$ movement if:</p> <ul style="list-style-type: none"> • Adequate improvements have been made to ensure U-turns can be safely completed at nearby intersections, and • An operational and/or safety issues are identified through the completion of a traffic study; or • The adjacent property redevelops, or • As part of roadway improvement project that adds capacity or a median to CO 83. <p>Access will be closed if:</p> <ul style="list-style-type: none"> • A cross access easement(s) is obtained with adjacent property(ies); and • Internal connectivity to/from Old Lasso Point (Access #16) or Kaessner Lane (Access #25) is developed.

1. The current State Highway Access Code shall govern any unresolved discrepancies regarding access decisions.

2. All access points are subject to consolidation upon the combining or subdividing of any lots under a single ownership or controlling interest.

3. All access locations +/- 50 feet (0.01 mile) unless otherwise noted.

4. The type, number, and storage length of lanes may be determined by a separate traffic study to be completed at the time of the actual design and implementation of the access plan and to ensure that the design does not create operational and/or safety issues.

5. Full movement access with potential to become/remain signalized or change to other full movement control, such as a roundabout. The design of any intermediate/final intersection control changes will be completed under a separate study to ensure that the design complies with the recommendations of the access control plan and does not create operational and/or safety issues.

6. A $\frac{3}{4}$ movement configuration means that vehicles can turn right into the access, turn right out of the access, and turn left into the access.

Exhibit - D Access Control Plan Table^{1,2}

Colorado State Highway 83 (El Paso County)

August 2021

Access # (Map #)	Milepost ³	Side of Road	Access Description	Existing Land Use	Existing Configuration	Ultimate Configuration	Notes/Conditions for Change ⁴
22 (5)	23.798	West	Private Driveway	Rural Residential	Full movement (un-signalized)	Closed	<p>Access may be restricted to right-in, right-out or $\frac{3}{4}$ movement if:</p> <ul style="list-style-type: none"> • Adequate improvements have been made to ensure U-turns can be safely completed at nearby intersections, and • An operational and/or safety issues are identified through the completion of a traffic study; or • The adjacent property redevelops, or • As part of roadway improvement project that adds capacity or a median to CO 83. <p>Access will be closed if:</p> <ul style="list-style-type: none"> • A cross access easement(s) is obtained with adjacent property(ies); and • Internal connectivity to/from Old Lasso Point (Access #16) or Kaessner Lane (Access #25) is developed.

1. The current State Highway Access Code shall govern any unresolved discrepancies regarding access decisions.

2. All access points are subject to consolidation upon the combining or subdividing of any lots under a single ownership or controlling interest.

3. All access locations +/- 50 feet (0.01 mile) unless otherwise noted.

4. The type, number, and storage length of lanes may be determined by a separate traffic study to be completed at the time of the actual design and implementation of the access plan and to ensure that the design does not create operational and/or safety issues.

5. Full movement access with potential to become/remain signalized or change to other full movement control, such as a roundabout. The design of any intermediate/final intersection control changes will be completed under a separate study to ensure that the design complies with the recommendations of the access control plan and does not create operational and/or safety issues.

6. A 3/4 movement configuration means that vehicles can turn right into the access, turn right out of the access, and turn left into the access.

Exhibit - D Access Control Plan Table^{1,2}

Colorado State Highway 83 (El Paso County)

August 2021

Access # (Map #)	Milepost ³	Side of Road	Access Description	Existing Land Use	Existing Configuration	Ultimate Configuration	Notes/Conditions for Change ⁴
23 (5)	23.904	West	Private Driveway	Rural Residential	Full movement (un-signalized)	Closed	<p>Access may be restricted to right-in, right-out or $\frac{3}{4}$ movement if:</p> <ul style="list-style-type: none"> • Adequate improvements have been made to ensure U-turns can be safely completed at nearby intersections, and • An operational and/or safety issues are identified through the completion of a traffic study; or • The adjacent property redevelops, or • As part of roadway improvement project that adds capacity or a median to CO 83. <p>Access will be closed if:</p> <ul style="list-style-type: none"> • A cross access easement is obtained with adjacent property(ies); and • Internal connectivity to/from Old Lasso Point (Access #16) or Kaessner Lane (Access #25) is developed.

1. The current State Highway Access Code shall govern any unresolved discrepancies regarding access decisions.

2. All access points are subject to consolidation upon the combining or subdividing of any lots under a single ownership or controlling interest.

3. All access locations +/- 50 feet (0.01 mile) unless otherwise noted.

4. The type, number, and storage length of lanes may be determined by a separate traffic study to be completed at the time of the actual design and implementation of the access plan and to ensure that the design does not create operational and/or safety issues.

5. Full movement access with potential to become/remain signalized or change to other full movement control, such as a roundabout. The design of any intermediate/final intersection control changes will be completed under a separate study to ensure that the design complies with the recommendations of the access control plan and does not create operational and/or safety issues.

6. A 3/4 movement configuration means that vehicles can turn right into the access, turn right out of the access, and turn left into the access.

Exhibit - D Access Control Plan Table^{1,2}

Colorado State Highway 83 (El Paso County)

August 2021

Access # (Map #)	Milepost ³	Side of Road	Access Description	Existing Land Use	Existing Configuration	Ultimate Configuration	Notes/Conditions for Change ⁴
24 (5)	23.970	East	Private Driveway	Rural Residential	Full movement (un-signalized)	Closed	Access may be restricted to right-in, right-out or ¾ movement if: <ul style="list-style-type: none"> • Adequate improvements have been made to ensure U-turns can be safely completed at nearby intersections, and • An operational and/or safety issues are identified through the completion of a traffic study; or • The adjacent property redevelops, or • As part of roadway improvement project that adds capacity or a median to CO 83. <p>Access will be closed when Access #75 is constructed.</p>
Milepost 24							
75 (6)	24.014	East	New Access	N/A	N/A	Full Movement⁵	New access to provide full movement access to parcel east of CO 83 with the ability to better accommodate U-turns if nearby accesses are restricted to less than full movement. Access #24 to be closed when Access #75 is constructed.
25 (6)	24.014	West	Kaessner Lane	Transportation (Public Roadway)	Full movement (un-signalized)	Full Movement⁵	Access design may be changed to better accommodate U-turns if nearby accesses are restricted to less than full movement.

1. The current State Highway Access Code shall govern any unresolved discrepancies regarding access decisions.
2. All access points are subject to consolidation upon the combining or subdividing of any lots under a single ownership or controlling interest.
3. All access locations +/- 50 feet (0.01 mile) unless otherwise noted.
4. The type, number, and storage length of lanes may be determined by a separate traffic study to be completed at the time of the actual design and implementation of the access plan and to ensure that the design does not create operational and/or safety issues.
5. Full movement access with potential to become/remain signalized or change to other full movement control, such as a roundabout. The design of any intermediate/final intersection control changes will be completed under a separate study to ensure that the design complies with the recommendations of the access control plan and does not create operational and/or safety issues.
6. A 3/4 movement configuration means that vehicles can turn right into the access, turn right out of the access, and turn left into the access.

Exhibit - D
Access Control Plan Table^{1,2}

Colorado State Highway 83 (El Paso County)

August 2021

Access # (Map #)	Milepost ³	Side of Road	Access Description	Existing Land Use	Existing Configuration	Ultimate Configuration	Notes/Conditions for Change ⁴
26 (6)	24.380	West	Private Driveway	Rural Residential	Full movement (un-signalized)	Closed	<p>Access may be restricted to right-in, right-out or ¾ movement if:</p> <ul style="list-style-type: none"> • Adequate improvements have been made to ensure U-turns can be safely completed at nearby intersections, and • An operational and/or safety issues are identified through the completion of a traffic study; or • The adjacent property redevelops, or • As part of roadway improvement project that adds capacity or a median to CO 83. <p>Access will be closed if:</p> <ul style="list-style-type: none"> • A cross access easement(s) is obtained with adjacent property(ies); and • Internal connectivity to/from Stagecoach Road (Access #29) is developed.

1. The current State Highway Access Code shall govern any unresolved discrepancies regarding access decisions.
2. All access points are subject to consolidation upon the combining or subdividing of any lots under a single ownership or controlling interest.
3. All access locations +/- 50 feet (0.01 mile) unless otherwise noted.
4. The type, number, and storage length of lanes may be determined by a separate traffic study to be completed at the time of the actual design and implementation of the access plan and to ensure that the design does not create operational and/or safety issues.
5. Full movement access with potential to become/remain signalized or change to other full movement control, such as a roundabout. The design of any intermediate/final intersection control changes will be completed under a separate study to ensure that the design complies with the recommendations of the access control plan and does not create operational and/or safety issues.
6. A 3/4 movement configuration means that vehicles can turn right into the access, turn right out of the access, and turn left into the access.

Exhibit - D Access Control Plan Table^{1,2}

Colorado State Highway 83 (El Paso County)

August 2021

Access # (Map #)	Milepost ³	Side of Road	Access Description	Existing Land Use	Existing Configuration	Ultimate Configuration	Notes/Conditions for Change ⁴
27 (6)	24.486	West	Private Driveway	Rural Residential	Full movement (un-signalized)	Closed	<p>Access may be restricted to right-in, right-out or $\frac{3}{4}$ movement if:</p> <ul style="list-style-type: none"> • Adequate improvements have been made to ensure U-turns can be safely completed at nearby intersections, and • An operational and/or safety issues are identified through the completion of a traffic study; or • The adjacent property redevelops, or • As part of roadway improvement project that adds capacity or a median to CO 83. <p>Access will be closed if:</p> <ul style="list-style-type: none"> • A cross access easement is obtained with adjacent property; and • Internal connectivity to/from Stagecoach Road (Access #29) is developed.
28 (6)	24.595	East	Stagecoach Road	Transportation (Public Roadway)	Full movement (un-signalized)	Full Movement⁵	Access design may be changed to better accommodate U-turns if nearby accesses are restricted to less than full movement.
29 (6)	24.595	West	Stagecoach Road	Transportation (Public Roadway)	Full movement (un-signalized)	Full Movement⁵	Access design may be changed to better accommodate U-turns if nearby accesses are restricted to less than full movement.

1. The current State Highway Access Code shall govern any unresolved discrepancies regarding access decisions.

2. All access points are subject to consolidation upon the combining or subdividing of any lots under a single ownership or controlling interest.

3. All access locations +/- 50 feet (0.01 mile) unless otherwise noted.

4. The type, number, and storage length of lanes may be determined by a separate traffic study to be completed at the time of the actual design and implementation of the access plan and to ensure that the design does not create operational and/or safety issues.

5. Full movement access with potential to become/remain signalized or change to other full movement control, such as a roundabout. The design of any intermediate/final intersection control changes will be completed under a separate study to ensure that the design complies with the recommendations of the access control plan and does not create operational and/or safety issues.

6. A $\frac{3}{4}$ movement configuration means that vehicles can turn right into the access, turn right out of the access, and turn left into the access.

Exhibit - D
Access Control Plan Table^{1,2}

Colorado State Highway 83 (El Paso County)

August 2021

Access # (Map #)	Milepost ³	Side of Road	Access Description	Existing Land Use	Existing Configuration	Ultimate Configuration	Notes/Conditions for Change ⁴
30 (7)	24.736	West	Private Driveway	Rural Residential	Full movement (un-signalized)	Closed	<p>Access may be restricted to right-in, right-out or ¾ movement if:</p> <ul style="list-style-type: none"> • Adequate improvements have been made to ensure U-turns can be safely completed at nearby intersections, and • An operational and/or safety issues are identified through the completion of a traffic study; or • The adjacent property redevelops, or • As part of roadway improvement project that adds capacity or a median to CO 83. <p>Access will be closed when internal connectivity to to/from Stagecoach Road, which the property abuts against, is developed.</p>

1. The current State Highway Access Code shall govern any unresolved discrepancies regarding access decisions.
2. All access points are subject to consolidation upon the combining or subdividing of any lots under a single ownership or controlling interest.
3. All access locations +/- 50 feet (0.01 mile) unless otherwise noted.
4. The type, number, and storage length of lanes may be determined by a separate traffic study to be completed at the time of the actual design and implementation of the access plan and to ensure that the design does not create operational and/or safety issues.
5. Full movement access with potential to become/remain signalized or change to other full movement control, such as a roundabout. The design of any intermediate/final intersection control changes will be completed under a separate study to ensure that the design complies with the recommendations of the access control plan and does not create operational and/or safety issues.
6. A 3/4 movement configuration means that vehicles can turn right into the access, turn right out of the access, and turn left into the access.

Exhibit - D Access Control Plan Table^{1,2}

Colorado State Highway 83 (El Paso County)

August 2021

Access # (Map #)	Milepost ³	Side of Road	Access Description	Existing Land Use	Existing Configuration	Ultimate Configuration	Notes/Conditions for Change ⁴
31 (7)	24.858	West	Private Driveway	Rural Residential	Full movement (un-signalized)	Closed	<p>Access may be restricted to right-in, right-out or ¾ movement if adequate improvements have been made to ensure U-turns can be safely completed at nearby intersections, and</p> <ul style="list-style-type: none"> • Adequate improvements have been made to ensure U-turns can be safely completed at nearby intersections, and • An operational and/or safety issues are identified through the completion of a traffic study; or • The adjacent property redevelops, or • As part of roadway improvement project that adds capacity or a median to CO 83. • A traffic signal is warranted. <p>Access will be closed if:</p> <ul style="list-style-type: none"> • A cross access easement is obtained with adjacent property; and • Internal connectivity to/from New Access #76 is developed
32 (7)	24.870	West	Private Driveway	Rural Residential	Full movement (un-signalized)	Closed	Access is secondary and can be closed without conditions.

1. The current State Highway Access Code shall govern any unresolved discrepancies regarding access decisions.

2. All access points are subject to consolidation upon the combining or subdividing of any lots under a single ownership or controlling interest.

3. All access locations +/- 50 feet (0.01 mile) unless otherwise noted.

4. The type, number, and storage length of lanes may be determined by a separate traffic study to be completed at the time of the actual design and implementation of the access plan and to ensure that the design does not create operational and/or safety issues.

5. Full movement access with potential to become/remain signalized or change to other full movement control, such as a roundabout. The design of any intermediate/final intersection control changes will be completed under a separate study to ensure that the design complies with the recommendations of the access control plan and does not create operational and/or safety issues.

6. A ¾ movement configuration means that vehicles can turn right into the access, turn right out of the access, and turn left into the access.

Exhibit - D Access Control Plan Table^{1,2}

Colorado State Highway 83 (El Paso County)

August 2021

Access # (Map #)	Milepost ³	Side of Road	Access Description	Existing Land Use	Existing Configuration	Ultimate Configuration	Notes/Conditions for Change ⁴
76 (7)	24.979	West	Private Driveway	Rural Residential	Full movement (un-signalized)	3/4 Movement⁶	<p>New access to provide restricted access to parcels west of CO 83 if:</p> <ul style="list-style-type: none"> • Redevelopment of the adjacent parcel occurs and cross access easement can be provided for nearby parcels, and • Adequate improvements have been made to ensure U-turns can be safely completed at nearby intersections. <p>Access #33 to be closed when Access #76 is constructed.</p>
Milepost 25							

1. The current State Highway Access Code shall govern any unresolved discrepancies regarding access decisions.

2. All access points are subject to consolidation upon the combining or subdividing of any lots under a single ownership or controlling interest.

3. All access locations +/- 50 feet (0.01 mile) unless otherwise noted.

4. The type, number, and storage length of lanes may be determined by a separate traffic study to be completed at the time of the actual design and implementation of the access plan and to ensure that the design does not create operational and/or safety issues.

5. Full movement access with potential to become/remain signalized or change to other full movement control, such as a roundabout. The design of any intermediate/final intersection control changes will be completed under a separate study to ensure that the design complies with the recommendations of the access control plan and does not create operational and/or safety issues.

6. A 3/4 movement configuration means that vehicles can turn right into the access, turn right out of the access, and turn left into the access.

Exhibit - D
Access Control Plan Table^{1,2}

Colorado State Highway 83 (El Paso County)

August 2021

Access # (Map #)	Milepost ³	Side of Road	Access Description	Existing Land Use	Existing Configuration	Ultimate Configuration	Notes/Conditions for Change ⁴
33 (7)	25.017	West	Private Driveway	Rural Residential	Full movement (un-signalized)	Closed	<p>Access may be restricted to right-in, right-out or ¾ movement if:</p> <ul style="list-style-type: none"> • An operational and/or safety issues are identified through the completion of a traffic study; or • The adjacent property redevelops, or • As part of roadway improvement project that adds capacity or a median to CO 83. <p>Access will be closed if:</p> <ul style="list-style-type: none"> • A cross access easement is obtained with adjacent property; and • Internal connectivity to/from Access #31 is developed, or • Access #76 is constructed.

1. The current State Highway Access Code shall govern any unresolved discrepancies regarding access decisions.
2. All access points are subject to consolidation upon the combining or subdividing of any lots under a single ownership or controlling interest.
3. All access locations +/- 50 feet (0.01 mile) unless otherwise noted.
4. The type, number, and storage length of lanes may be determined by a separate traffic study to be completed at the time of the actual design and implementation of the access plan and to ensure that the design does not create operational and/or safety issues.
5. Full movement access with potential to become/remain signalized or change to other full movement control, such as a roundabout. The design of any intermediate/final intersection control changes will be completed under a separate study to ensure that the design complies with the recommendations of the access control plan and does not create operational and/or safety issues.
6. A 3/4 movement configuration means that vehicles can turn right into the access, turn right out of the access, and turn left into the access.

Exhibit - D
Access Control Plan Table^{1,2}

Colorado State Highway 83 (El Paso County)

August 2021

Access # (Map #)	Milepost ³	Side of Road	Access Description	Existing Land Use	Existing Configuration	Ultimate Configuration	Notes/Conditions for Change ⁴
34 (7)	25.032	East	Private Driveway	Rural Residential	Full movement (un-signalized)	Closed	<p>Access may be restricted to right-in, right-out or ¾ movement if:</p> <ul style="list-style-type: none"> • Adequate improvements have been made to ensure U-turns can be safely completed at nearby intersections, and • An operational and/or safety issues are identified through the completion of a traffic study; or • The adjacent property redevelops, or • As part of roadway improvement project that adds capacity or a median to CO 83. <p>Access will be closed if:</p> <ul style="list-style-type: none"> • A cross access easement(s) is obtained with adjacent property(ies); and • Internal connectivity to/from other local roads is developed.

1. The current State Highway Access Code shall govern any unresolved discrepancies regarding access decisions.
2. All access points are subject to consolidation upon the combining or subdividing of any lots under a single ownership or controlling interest.
3. All access locations +/- 50 feet (0.01 mile) unless otherwise noted.
4. The type, number, and storage length of lanes may be determined by a separate traffic study to be completed at the time of the actual design and implementation of the access plan and to ensure that the design does not create operational and/or safety issues.
5. Full movement access with potential to become/remain signalized or change to other full movement control, such as a roundabout. The design of any intermediate/final intersection control changes will be completed under a separate study to ensure that the design complies with the recommendations of the access control plan and does not create operational and/or safety issues.
6. A 3/4 movement configuration means that vehicles can turn right into the access, turn right out of the access, and turn left into the access.

Exhibit - D
Access Control Plan Table^{1,2}

Colorado State Highway 83 (El Paso County)

August 2021

Access # (Map #)	Milepost ³	Side of Road	Access Description	Existing Land Use	Existing Configuration	Ultimate Configuration	Notes/Conditions for Change ⁴
35 (7)	25.082	West	Private Driveway	Rural Residential	Full movement (un-signalized)	Closed	<p>Access may be restricted to right-in, right-out or ¾ movement if:</p> <ul style="list-style-type: none"> • Adequate improvements have been made to ensure U-turns can be safely completed at nearby intersections, and • An operational and/or safety issues are identified through the completion of a traffic study; or • The adjacent property redevelops, or • As part of roadway improvement project that adds capacity or a median to CO 83. <p>Access will be closed if:</p> <ul style="list-style-type: none"> • A cross access easement(s) is obtained with adjacent property(ies); and • Internal connectivity to/from Access #76 or Access #77 is developed.

1. The current State Highway Access Code shall govern any unresolved discrepancies regarding access decisions.
2. All access points are subject to consolidation upon the combining or subdividing of any lots under a single ownership or controlling interest.
3. All access locations +/- 50 feet (0.01 mile) unless otherwise noted.
4. The type, number, and storage length of lanes may be determined by a separate traffic study to be completed at the time of the actual design and implementation of the access plan and to ensure that the design does not create operational and/or safety issues.
5. Full movement access with potential to become/remain signalized or change to other full movement control, such as a roundabout. The design of any intermediate/final intersection control changes will be completed under a separate study to ensure that the design complies with the recommendations of the access control plan and does not create operational and/or safety issues.
6. A 3/4 movement configuration means that vehicles can turn right into the access, turn right out of the access, and turn left into the access.

Exhibit - D Access Control Plan Table^{1,2}

Colorado State Highway 83 (El Paso County)

August 2021

Access # (Map #)	Milepost ³	Side of Road	Access Description	Existing Land Use	Existing Configuration	Ultimate Configuration	Notes/Conditions for Change ⁴
36 (7)	25.162	West	Private Driveway	Transportation (Public Roadway)	Full movement (un-signalized)	Closed	<p>Access may be restricted to right-in, right-out or ¾ movement if:</p> <ul style="list-style-type: none"> • Adequate improvements have been made to ensure U-turns can be safely completed at nearby intersections, and • An operational and/or safety issues are identified through the completion of a traffic study; or • The adjacent property redevelops, or • As part of roadway improvement project that adds capacity or a median to CO 83. <p>Access will be closed if:</p> <ul style="list-style-type: none"> • A cross access easement is obtained with adjacent property; and • Internal connectivity to/from Access #77 is developed.
77 (7)	25.286	West	New Access	N/A	N/A	Full Movement⁵	<p>New access to provide full movement access to parcels west of CO 83 with the ability to better accommodate U-turns if nearby accesses are restricted to less than full movement.</p> <p>Access #38 to be closed when Access #77 is constructed.</p>

1. The current State Highway Access Code shall govern any unresolved discrepancies regarding access decisions.

2. All access points are subject to consolidation upon the combining or subdividing of any lots under a single ownership or controlling interest.

3. All access locations +/- 50 feet (0.01 mile) unless otherwise noted.

4. The type, number, and storage length of lanes may be determined by a separate traffic study to be completed at the time of the actual design and implementation of the access plan and to ensure that the design does not create operational and/or safety issues.

5. Full movement access with potential to become/remain signalized or change to other full movement control, such as a roundabout. The design of any intermediate/final intersection control changes will be completed under a separate study to ensure that the design complies with the recommendations of the access control plan and does not create operational and/or safety issues.

6. A 3/4 movement configuration means that vehicles can turn right into the access, turn right out of the access, and turn left into the access.

Exhibit - D Access Control Plan Table^{1,2}

Colorado State Highway 83 (El Paso County)

August 2021

Access # (Map #)	Milepost ³	Side of Road	Access Description	Existing Land Use	Existing Configuration	Ultimate Configuration	Notes/Conditions for Change ⁴
37 (7)	25.286	East	High Forest Road	Transportation (Public Roadway)	Full movement (un-signalized)	Full Movement⁵	Access design may be changed to better accommodate U-turns if nearby accesses are restricted to less than full movement.
38 (7)	25.306	West	Private Driveway	Rural Residential	Full movement (un-signalized)	Closed	<p>Access may be restricted to right-in, right-out or ¾ movement if:</p> <ul style="list-style-type: none"> • Adequate improvements have been made to ensure U-turns can be safely completed at nearby intersections, and • An operational and/or safety issues are identified through the completion of a traffic study; or • The adjacent property redevelops, or • As part of roadway improvement project that adds capacity or a median to CO 83. <p>Access will be closed if:</p> <ul style="list-style-type: none"> • A cross access easement is obtained with adjacent property; and • Internal connectivity to/from Access #77 or Arena Road (Access #39) is developed.

1. The current State Highway Access Code shall govern any unresolved discrepancies regarding access decisions.

2. All access points are subject to consolidation upon the combining or subdividing of any lots under a single ownership or controlling interest.

3. All access locations +/- 50 feet (0.01 mile) unless otherwise noted.

4. The type, number, and storage length of lanes may be determined by a separate traffic study to be completed at the time of the actual design and implementation of the access plan and to ensure that the design does not create operational and/or safety issues.

5. Full movement access with potential to become/remain signalized or change to other full movement control, such as a roundabout. The design of any intermediate/final intersection control changes will be completed under a separate study to ensure that the design complies with the recommendations of the access control plan and does not create operational and/or safety issues.

6. A 3/4 movement configuration means that vehicles can turn right into the access, turn right out of the access, and turn left into the access.

Exhibit - D Access Control Plan Table^{1,2}

Colorado State Highway 83 (El Paso County)

August 2021

Access # (Map #)	Milepost ³	Side of Road	Access Description	Existing Land Use	Existing Configuration	Ultimate Configuration	Notes/Conditions for Change ⁴
39 (7)	25.381	West	Arena Road	Transportation (Public Roadway)	Full movement (un-signalized)	Closed	<p>Access may be restricted to right-in, right-out or $\frac{3}{4}$ movement if:</p> <ul style="list-style-type: none"> • Adequate improvements have been made to ensure U-turns can be safely completed at nearby intersections, and • An operational and/or safety issues are identified through the completion of a traffic study; or • The adjacent property redevelops, or • As part of roadway improvement project that adds capacity or a median to CO 83. <p>Access will be closed if:</p> <ul style="list-style-type: none"> • A cross access easement is obtained with adjacent properties; and • Internal connectivity to/from Access #77 is developed.

1. The current State Highway Access Code shall govern any unresolved discrepancies regarding access decisions.

2. All access points are subject to consolidation upon the combining or subdividing of any lots under a single ownership or controlling interest.

3. All access locations +/- 50 feet (0.01 mile) unless otherwise noted.

4. The type, number, and storage length of lanes may be determined by a separate traffic study to be completed at the time of the actual design and implementation of the access plan and to ensure that the design does not create operational and/or safety issues.

5. Full movement access with potential to become/remain signalized or change to other full movement control, such as a roundabout. The design of any intermediate/final intersection control changes will be completed under a separate study to ensure that the design complies with the recommendations of the access control plan and does not create operational and/or safety issues.

6. A $\frac{3}{4}$ movement configuration means that vehicles can turn right into the access, turn right out of the access, and turn left into the access.

Exhibit - D
Access Control Plan Table^{1,2}

Colorado State Highway 83 (El Paso County)

August 2021

Access # (Map #)	Milepost ³	Side of Road	Access Description	Existing Land Use	Existing Configuration	Ultimate Configuration	Notes/Conditions for Change ⁴
40 (8)	25.450	West	Private Driveway	Rural Residential	Full movement (un-signalized)	Closed	<p>Access may be restricted to right-in, right-out or ¾ movement if:</p> <ul style="list-style-type: none"> • Adequate improvements have been made to ensure U-turns can be safely completed at nearby intersections, and • An operational and/or safety issues are identified through the completion of a traffic study; or • The adjacent property redevelops, or • As part of roadway improvement project that adds capacity or a median to CO 83. <p>Access will be closed if internal connectivity to/from Arena Road, which the property abuts against, is developed.</p>

1. The current State Highway Access Code shall govern any unresolved discrepancies regarding access decisions.
2. All access points are subject to consolidation upon the combining or subdividing of any lots under a single ownership or controlling interest.
3. All access locations +/- 50 feet (0.01 mile) unless otherwise noted.
4. The type, number, and storage length of lanes may be determined by a separate traffic study to be completed at the time of the actual design and implementation of the access plan and to ensure that the design does not create operational and/or safety issues.
5. Full movement access with potential to become/remain signalized or change to other full movement control, such as a roundabout. The design of any intermediate/final intersection control changes will be completed under a separate study to ensure that the design complies with the recommendations of the access control plan and does not create operational and/or safety issues.
6. A 3/4 movement configuration means that vehicles can turn right into the access, turn right out of the access, and turn left into the access.

Exhibit - D Access Control Plan Table^{1,2}

Colorado State Highway 83 (El Paso County)

August 2021

Access # (Map #)	Milepost ³	Side of Road	Access Description	Existing Land Use	Existing Configuration	Ultimate Configuration	Notes/Conditions for Change ⁴
41 (8)	25.537	West	Private Driveway	Rural Residential	Full movement (un-signalized)	Closed	<p>Access may be restricted to right-in, right-out or ¾ movement if:</p> <ul style="list-style-type: none"> • Adequate improvements have been made to ensure U-turns can be safely completed at nearby intersections, and • An operational and/or safety issues are identified through the completion of a traffic study; or • The adjacent property redevelops, or • As part of roadway improvement project that adds capacity or a median to CO 83. <p>Access will be closed if:</p> <ul style="list-style-type: none"> • A cross access easement is obtained with adjacent property; and • Internal connectivity to/from Arena Road is developed.
42 (8)	25.870	East	Hodgen Road	Transportation (Public Roadway)	Full movement (signalized)	Full Movement⁵	Access design may be changed to better accommodate U-turns if nearby accesses are restricted to less than full movement.
43 (8)	25.870	West	Hodgen Road	Transportation (Public Roadway)	Full movement (signalized)	Full Movement⁵	Access design may be changed to better accommodate U-turns if nearby accesses are restricted to less than full movement.
Milepost 26							
44 (8)	26.066	East	Gated Field Access	Open Field	Full movement (un-signalized)	Closed	Access is a secondary access to adjacent properties and can be closed without any conditions.

1. The current State Highway Access Code shall govern any unresolved discrepancies regarding access decisions.

2. All access points are subject to consolidation upon the combining or subdividing of any lots under a single ownership or controlling interest.

3. All access locations +/- 50 feet (0.01 mile) unless otherwise noted.

4. The type, number, and storage length of lanes may be determined by a separate traffic study to be completed at the time of the actual design and implementation of the access plan and to ensure that the design does not create operational and/or safety issues.

5. Full movement access with potential to become/remains signalized or change to other full movement control, such as a roundabout. The design of any intermediate/final intersection control changes will be completed under a separate study to ensure that the design complies with the recommendations of the access control plan and does not create operational and/or safety issues.

6. A 3/4 movement configuration means that vehicles can turn right into the access, turn right out of the access, and turn left into the access.

Exhibit - D Access Control Plan Table^{1,2}

Colorado State Highway 83 (El Paso County)

August 2021

Access # (Map #)	Milepost ³	Side of Road	Access Description	Existing Land Use	Existing Configuration	Ultimate Configuration	Notes/Conditions for Change ⁴
45 (9)	26.368	East	Private Driveway	Rural Residential	Full movement (un-signalized)	Emergency Access Only (gated)	Access may be restricted to emergency access (gated) only (access to the property to be obtained from local roads such as Blue Heron Springs Lane or Needles Drive) if: <ul style="list-style-type: none"> The adjacent property redevelops; or Operational and/or safety issues are identified through the completion of a traffic study.
46 (9)	26.371	West	Field Access	Rural Residential	Closed	Closed	Access to remain closed.
Milepost 27							
78 (10)	26.836	West	New Access	N/A	N/A	Full Movement⁵	New access to provide full movement access to parcels west of CO 83 with the ability to better accommodate U-turns if nearby accesses are restricted to less than full movement.
79 (10)	26.836	East	New Access	N/A	N/A	Full Movement⁵	New access to provide full movement access to parcels west of CO 83 with the ability to better accommodate U-turns if nearby accesses are restricted to less than full movement. Access #47 and Access #48 to be closed when Access #79 is constructed.

1. The current State Highway Access Code shall govern any unresolved discrepancies regarding access decisions.
2. All access points are subject to consolidation upon the combining or subdividing of any lots under a single ownership or controlling interest.
3. All access locations +/- 50 feet (0.01 mile) unless otherwise noted.
4. The type, number, and storage length of lanes may be determined by a separate traffic study to be completed at the time of the actual design and implementation of the access plan and to ensure that the design does not create operational and/or safety issues.
5. Full movement access with potential to become/remain signalized or change to other full movement control, such as a roundabout. The design of any intermediate/final intersection control changes will be completed under a separate study to ensure that the design complies with the recommendations of the access control plan and does not create operational and/or safety issues.
6. A 3/4 movement configuration means that vehicles can turn right into the access, turn right out of the access, and turn left into the access.

Exhibit - D Access Control Plan Table^{1,2}

Colorado State Highway 83 (El Paso County)

August 2021

Access # (Map #)	Milepost ³	Side of Road	Access Description	Existing Land Use	Existing Configuration	Ultimate Configuration	Notes/Conditions for Change ⁴
47 (10)	27.094	East	Private Driveway	Rural Residential	Full movement (un-signalized)	Access to be closed.	<p>Access may be restricted to less than full movement if:</p> <ul style="list-style-type: none"> • Adequate improvements have been made to ensure U-turns can be safely completed at nearby intersections, and • A roadway improvement project adds capacity or a median to CO 83; or • The adjacent property redevelops; or • Operational and/or safety issues are identified through the completion of a traffic study; or • A traffic signal is warranted. <p>Access will be closed if:</p> <ul style="list-style-type: none"> • A cross access easement(s) is obtained with adjacent property(ies) and internal connectivity to/from Walden Way (Access #51) is developed; or • Access #79 is constructed.
48 (10)	27.126	East	Gated Field Access	Open Field	Full movement (un-signalized)	Closed	Access is a secondary access to adjacent properties and can be closed without any conditions.

1. The current State Highway Access Code shall govern any unresolved discrepancies regarding access decisions.

2. All access points are subject to consolidation upon the combining or subdividing of any lots under a single ownership or controlling interest.

3. All access locations +/- 50 feet (0.01 mile) unless otherwise noted.

4. The type, number, and storage length of lanes may be determined by a separate traffic study to be completed at the time of the actual design and implementation of the access plan and to ensure that the design does not create operational and/or safety issues.

5. Full movement access with potential to become/remain signalized or change to other full movement control, such as a roundabout. The design of any intermediate/final intersection control changes will be completed under a separate study to ensure that the design complies with the recommendations of the access control plan and does not create operational and/or safety issues.

6. A 3/4 movement configuration means that vehicles can turn right into the access, turn right out of the access, and turn left into the access.

Exhibit - D
Access Control Plan Table^{1,2}

Colorado State Highway 83 (El Paso County)

August 2021

Access # (Map #)	Milepost ³	Side of Road	Access Description	Existing Land Use	Existing Configuration	Ultimate Configuration	Notes/Conditions for Change ⁴
49 (10)	27.337	East	Private Driveway	Rural Residential	Full movement (un-signalized)	Closed	<p>Access may be restricted to right-in, right-out or ¾ movement if:</p> <ul style="list-style-type: none"> • Adequate improvements have been made to ensure U-turns can be safely completed at nearby intersections, and • An operational and/or safety issues are identified through the completion of a traffic study; or • The adjacent property redevelops, or • As part of roadway improvement project that adds capacity or a median to CO 83. <p>Access will be closed if:</p> <ul style="list-style-type: none"> • A cross access easement is obtained with adjacent property; and • Internal connectivity to/from Walden Way (Access #51) is developed.

1. The current State Highway Access Code shall govern any unresolved discrepancies regarding access decisions.
2. All access points are subject to consolidation upon the combining or subdividing of any lots under a single ownership or controlling interest.
3. All access locations +/- 50 feet (0.01 mile) unless otherwise noted.
4. The type, number, and storage length of lanes may be determined by a separate traffic study to be completed at the time of the actual design and implementation of the access plan and to ensure that the design does not create operational and/or safety issues.
5. Full movement access with potential to become/remain signalized or change to other full movement control, such as a roundabout. The design of any intermediate/final intersection control changes will be completed under a separate study to ensure that the design complies with the recommendations of the access control plan and does not create operational and/or safety issues.
6. A 3/4 movement configuration means that vehicles can turn right into the access, turn right out of the access, and turn left into the access.

Exhibit - D Access Control Plan Table^{1,2}

Colorado State Highway 83 (El Paso County)

August 2021

Access # (Map #)	Milepost ³	Side of Road	Access Description	Existing Land Use	Existing Configuration	Ultimate Configuration	Notes/Conditions for Change ⁴
50 (10)	27.445	West	Private Driveway	Rural Residential	Full movement (un-signalized)	Closed	<p>Access may be restricted to right-in, right-out or ¾ movement if:</p> <ul style="list-style-type: none"> • Adequate improvements have been made to ensure U-turns can be safely completed at nearby intersections, and • An operational and/or safety issues are identified through the completion of a traffic study; or • The adjacent property redevelops, or • As part of roadway improvement project that adds capacity or a median to CO 83. <p>Access will be closed when Access #80 is constructed.</p>
51 (10)	27.463	East	Walden Way	Transportation (Public Roadway)	Full movement (un-signalized)	Full Movement⁵	Access design may be changed to better accommodate U-turns if nearby accesses are restricted to less than full movement.
80 (10)	27.463	West	New Access	N/A	N/A	Full Movement⁵	<p>New Access to provide full movement to adjacent parcels with the ability to better accommodate U-turns if nearby accesses are restricted to less than full movement.</p> <p>Access #50 to be closed when Access #80 is constructed.</p>

1. The current State Highway Access Code shall govern any unresolved discrepancies regarding access decisions.
2. All access points are subject to consolidation upon the combining or subdividing of any lots under a single ownership or controlling interest.
3. All access locations +/- 50 feet (0.01 mile) unless otherwise noted.
4. The type, number, and storage length of lanes may be determined by a separate traffic study to be completed at the time of the actual design and implementation of the access plan and to ensure that the design does not create operational and/or safety issues.
5. Full movement access with potential to become/remain signalized or change to other full movement control, such as a roundabout. The design of any intermediate/final intersection control changes will be completed under a separate study to ensure that the design complies with the recommendations of the access control plan and does not create operational and/or safety issues.
6. A 3/4 movement configuration means that vehicles can turn right into the access, turn right out of the access, and turn left into the access.

Exhibit - D Access Control Plan Table^{1,2}

Colorado State Highway 83 (El Paso County)

August 2021

Access # (Map #)	Milepost ³	Side of Road	Access Description	Existing Land Use	Existing Configuration	Ultimate Configuration	Notes/Conditions for Change ⁴
52 (10)	27.546	West	Gated Field Access	Open Field	Full movement (un-signalized)	Closed	<p>Access may be restricted to right-in, right-out or $\frac{3}{4}$ movement if:</p> <ul style="list-style-type: none"> • Adequate improvements have been made to ensure U-turns can be safely completed at nearby intersections, and • An operational and/or safety issues are identified through the completion of a traffic study; or • The adjacent property redevelops, or • As part of roadway improvement project that adds capacity or a median to CO 83. <p>Access will be closed if:</p> <ul style="list-style-type: none"> • A cross access easement is obtained with adjacent property; and • New roadway/driveway to provide access to/from Access #80 is developed.

1. The current State Highway Access Code shall govern any unresolved discrepancies regarding access decisions.

2. All access points are subject to consolidation upon the combining or subdividing of any lots under a single ownership or controlling interest.

3. All access locations +/- 50 feet (0.01 mile) unless otherwise noted.

4. The type, number, and storage length of lanes may be determined by a separate traffic study to be completed at the time of the actual design and implementation of the access plan and to ensure that the design does not create operational and/or safety issues.

5. Full movement access with potential to become/remain signalized or change to other full movement control, such as a roundabout. The design of any intermediate/final intersection control changes will be completed under a separate study to ensure that the design complies with the recommendations of the access control plan and does not create operational and/or safety issues.

6. A $\frac{3}{4}$ movement configuration means that vehicles can turn right into the access, turn right out of the access, and turn left into the access.

Exhibit - D Access Control Plan Table^{1,2}

Colorado State Highway 83 (El Paso County)

August 2021

Access # (Map #)	Milepost ³	Side of Road	Access Description	Existing Land Use	Existing Configuration	Ultimate Configuration	Notes/Conditions for Change ⁴
53 (11)	27.583	East	Private Driveway	Rural Residential	Full movement (un-signalized)	Closed	<p>Access may be restricted to right-in, right-out or $\frac{3}{4}$ movement if:</p> <ul style="list-style-type: none"> • Adequate improvements have been made to ensure U-turns can be safely completed at nearby intersections, and • An operational and/or safety issues are identified through the completion of a traffic study; or • The adjacent property redevelops, or • As part of roadway improvement project that adds capacity or a median to CO 83. <p>Access will be closed if:</p> <ul style="list-style-type: none"> • A cross access easement is obtained with adjacent property; and • Internal connectivity to/from Walden Way (Access #51) is developed.

1. The current State Highway Access Code shall govern any unresolved discrepancies regarding access decisions.
2. All access points are subject to consolidation upon the combining or subdividing of any lots under a single ownership or controlling interest.
3. All access locations +/- 50 feet (0.01 mile) unless otherwise noted.
4. The type, number, and storage length of lanes may be determined by a separate traffic study to be completed at the time of the actual design and implementation of the access plan and to ensure that the design does not create operational and/or safety issues.
5. Full movement access with potential to become/remain signalized or change to other full movement control, such as a roundabout. The design of any intermediate/final intersection control changes will be completed under a separate study to ensure that the design complies with the recommendations of the access control plan and does not create operational and/or safety issues.
6. A $\frac{3}{4}$ movement configuration means that vehicles can turn right into the access, turn right out of the access, and turn left into the access.

Exhibit - D Access Control Plan Table^{1,2}

Colorado State Highway 83 (El Paso County)

August 2021

Access # (Map #)	Milepost ³	Side of Road	Access Description	Existing Land Use	Existing Configuration	Ultimate Configuration	Notes/Conditions for Change ⁴
54 (11)	27.604	West	Private Driveway	Rural Residential	Full movement (un-signalized)	Access to be closed	<p>Access may be restricted to right-in, right-out or ¾ movement if adequate improvements have been made to ensure U-turns can be safely completed at nearby intersections, and</p> <ul style="list-style-type: none"> • Adequate improvements have been made to ensure U-turns can be safely completed at nearby intersections, and • An operational and/or safety issues are identified through the completion of a traffic study; or • The adjacent property redevelops, or • As part of roadway improvement project that adds capacity or a median to CO 83. <p>Access will be closed if:</p> <ul style="list-style-type: none"> • A cross access easement is obtained with adjacent property(ies); and • Internal connectivity to/from Access #80 or Old Colorado Highway 105 developed.

1. The current State Highway Access Code shall govern any unresolved discrepancies regarding access decisions.

2. All access points are subject to consolidation upon the combining or subdividing of any lots under a single ownership or controlling interest.

3. All access locations +/- 50 feet (0.01 mile) unless otherwise noted.

4. The type, number, and storage length of lanes may be determined by a separate traffic study to be completed at the time of the actual design and implementation of the access plan and to ensure that the design does not create operational and/or safety issues.

5. Full movement access with potential to become/remain signalized or change to other full movement control, such as a roundabout. The design of any intermediate/final intersection control changes will be completed under a separate study to ensure that the design complies with the recommendations of the access control plan and does not create operational and/or safety issues.

6. A 3/4 movement configuration means that vehicles can turn right into the access, turn right out of the access, and turn left into the access.

Exhibit - D Access Control Plan Table^{1,2}

Colorado State Highway 83 (El Paso County)

August 2021

Access # (Map #)	Milepost ³	Side of Road	Access Description	Existing Land Use	Existing Configuration	Ultimate Configuration	Notes/Conditions for Change ⁴
55 (11)	27.608	East	Private Driveway	Rural Residential	Full movement (un-signalized)	Closed	<p>Access may be restricted to right-in, right-out or ¾ movement if:</p> <ul style="list-style-type: none"> • Adequate improvements have been made to ensure U-turns can be safely completed at nearby intersections, and • An operational and/or safety issues are identified through the completion of a traffic study; or • The adjacent property redevelops, or • As part of roadway improvement project that adds capacity or a median to CO 83. <p>Access will be closed if:</p> <ul style="list-style-type: none"> • A cross access easement(s) is obtained with adjacent property(ies); and • Internal connectivity to/from Walden Way (Access #51) is developed.
56 (11)	27.741	East	Private Driveway	Civic (Monument Academy High School)	Right-in Only	Right-in Only	None.
57 (11)	27.873	East	Private Driveway	Utility Access	Full movement (un-signalized)	Closed	Access to be closed when serving parcel is vacated.
Milepost 28							
58 (11)	28.132	East	Walker Road	Transportation (Public Roadway)	Full movement (signalized)	Full Movement⁵	Access design may be changed to better accommodate U-turns if nearby accesses are restricted to less than full movement.

1. The current State Highway Access Code shall govern any unresolved discrepancies regarding access decisions.
2. All access points are subject to consolidation upon the combining or subdividing of any lots under a single ownership or controlling interest.
3. All access locations +/- 50 feet (0.01 mile) unless otherwise noted.
4. The type, number, and storage length of lanes may be determined by a separate traffic study to be completed at the time of the actual design and implementation of the access plan and to ensure that the design does not create operational and/or safety issues.
5. Full movement access with potential to become/remain signalized or change to other full movement control, such as a roundabout. The design of any intermediate/final intersection control changes will be completed under a separate study to ensure that the design complies with the recommendations of the access control plan and does not create operational and/or safety issues.
6. A 3/4 movement configuration means that vehicles can turn right into the access, turn right out of the access, and turn left into the access.

Exhibit - D
Access Control Plan Table^{1,2}

Colorado State Highway 83 (El Paso County)

August 2021

Access # (Map #)	Milepost ³	Side of Road	Access Description	Existing Land Use	Existing Configuration	Ultimate Configuration	Notes/Conditions for Change ⁴
59 (11)	28.132	West	Old Colorado Highway 105	Transportation (Public Roadway)	Full movement (signalized)	Full Movement⁵	Access design may be changed to better accommodate U-turns if nearby accesses are restricted to less than full movement.
60 (12)	28.360	West	Gated Field Access	Open Field	Full movement (un-signalized)	Closed	<p>Access may be restricted to right-in, right-out or ¾ movement if:</p> <ul style="list-style-type: none"> • Adequate improvements have been made to ensure U-turns can be safely completed at nearby intersections, and • An operational and/or safety issues are identified through the completion of a traffic study; or • The adjacent property redevelops, or • As part of roadway improvement project that adds capacity or a median to CO 83. <p>Access will be closed if:</p> <ul style="list-style-type: none"> • A cross access easement is obtained with adjacent property; and • Internal connectivity to/from Access #82 or Old Highway 105 is developed.
61 (12)	28.363	West	Gated Field Access	Open Field	Full movement (un-signalized)	Closed	Access is secondary access to property and may be closed without condition or will be closed when Access #82 is constructed.

1. The current State Highway Access Code shall govern any unresolved discrepancies regarding access decisions.
2. All access points are subject to consolidation upon the combining or subdividing of any lots under a single ownership or controlling interest.
3. All access locations +/- 50 feet (0.01 mile) unless otherwise noted.
4. The type, number, and storage length of lanes may be determined by a separate traffic study to be completed at the time of the actual design and implementation of the access plan and to ensure that the design does not create operational and/or safety issues.
5. Full movement access with potential to become/remain signalized or change to other full movement control, such as a roundabout. The design of any intermediate/final intersection control changes will be completed under a separate study to ensure that the design complies with the recommendations of the access control plan and does not create operational and/or safety issues.
6. A 3/4 movement configuration means that vehicles can turn right into the access, turn right out of the access, and turn left into the access.

Exhibit - D
Access Control Plan Table^{1,2}

Colorado State Highway 83 (El Paso County)

August 2021

Access # (Map #)	Milepost ³	Side of Road	Access Description	Existing Land Use	Existing Configuration	Ultimate Configuration	Notes/Conditions for Change ⁴
81 (12)	28.599	East	New Access	N/A	N/A	Full Movement⁵	New access to provide full movement access to parcel east of CO 83 with the ability to better accommodate U-turns if nearby accesses are restricted to less than full movement. Access #62 and #64 to be closed when Access #81 is constructed.
82 (12)	28.599	West	New Access	N/A	N/A	Full Movement⁵	New access to provide full movement access to parcel west of CO 83 with the ability to better accommodate U-turns if nearby accesses are restricted to less than full movement. Access #61, #63, #65, and #66 to be closed when Access #82 is constructed.
62 (12)	28.684	East	Gated Field Access	Open Field	Full movement (un-signalized)	Closed	Access is secondary access to property and may be closed without condition or will be closed when Access #81 is constructed.
63 (12)	28.693	West	Gated Field Access	Open Field	Full movement (un-signalized)	Closed	Access is secondary access to property and may be closed without condition or will be closed when Access #82 is constructed.

1. The current State Highway Access Code shall govern any unresolved discrepancies regarding access decisions.
2. All access points are subject to consolidation upon the combining or subdividing of any lots under a single ownership or controlling interest.
3. All access locations +/- 50 feet (0.01 mile) unless otherwise noted.
4. The type, number, and storage length of lanes may be determined by a separate traffic study to be completed at the time of the actual design and implementation of the access plan and to ensure that the design does not create operational and/or safety issues.
5. Full movement access with potential to become/remain signalized or change to other full movement control, such as a roundabout. The design of any intermediate/final intersection control changes will be completed under a separate study to ensure that the design complies with the recommendations of the access control plan and does not create operational and/or safety issues.
6. A 3/4 movement configuration means that vehicles can turn right into the access, turn right out of the access, and turn left into the access.

Exhibit - D Access Control Plan Table^{1,2}

Colorado State Highway 83 (El Paso County)

August 2021

Access # (Map #)	Milepost ³	Side of Road	Access Description	Existing Land Use	Existing Configuration	Ultimate Configuration	Notes/Conditions for Change ⁴
64 (12)	28.747	East	Gated Field Access	Open Field	Full movement (un-signalized)	Closed	<p>Access may be restricted to right-in, right-out or ¾ movement if:</p> <ul style="list-style-type: none"> • Adequate improvements have been made to ensure U-turns can be safely completed at nearby intersections, and • An operational and/or safety issues are identified through the completion of a traffic study; or • The adjacent property redevelops, or • As part of roadway improvement project that adds capacity or a median to CO 83. <p>Access will be closed when Access #81 is constructed.</p>
65 (12)	28.885	West	Gated Field Access	Open Field	Full movement (un-signalized)	Closed	Access is secondary access to property and may be closed without condition or will be closed when Access #82 is constructed.
66 (12)	28.901	West	Gated Field Access	Open Field	Full movement (un-signalized)	Closed	Access is secondary access to property and may be closed without condition or will be closed when Access #82 is constructed.
Milepost 29							
67 (13)	29.114	East	Gated Field Access	Open Field	Full movement (un-signalized)	Closed	Access is secondary access to property and may be closed without condition.

1. The current State Highway Access Code shall govern any unresolved discrepancies regarding access decisions.
2. All access points are subject to consolidation upon the combining or subdividing of any lots under a single ownership or controlling interest.
3. All access locations +/- 50 feet (0.01 mile) unless otherwise noted.
4. The type, number, and storage length of lanes may be determined by a separate traffic study to be completed at the time of the actual design and implementation of the access plan and to ensure that the design does not create operational and/or safety issues.
5. Full movement access with potential to become/remains signalized or change to other full movement control, such as a roundabout. The design of any intermediate/final intersection control changes will be completed under a separate study to ensure that the design complies with the recommendations of the access control plan and does not create operational and/or safety issues.
6. A 3/4 movement configuration means that vehicles can turn right into the access, turn right out of the access, and turn left into the access.

Exhibit - D Access Control Plan Table^{1,2}

Colorado State Highway 83 (El Paso County)

August 2021

Access # (Map #)	Milepost ³	Side of Road	Access Description	Existing Land Use	Existing Configuration	Ultimate Configuration	Notes/Conditions for Change ⁴
68 (13)	29.203	West	Private Driveway	Rural Residential	Full movement (un-signalized)	Closed	<p>Access may be restricted to right-in, right-out or $\frac{3}{4}$ movement if:</p> <ul style="list-style-type: none"> • Adequate improvements have been made to ensure U-turns can be safely completed at nearby intersections, and • An operational and/or safety issues are identified through the completion of a traffic study; or • The adjacent property redevelops, or • As part of roadway improvement project that adds capacity or a median to CO 83. <p>Access will be closed if:</p> <ul style="list-style-type: none"> • Internal connectivity to/from Access #69, which the property abuts against, is constructed.
69 (13)	29.590	West	Private Driveway	Rural Residential	Full movement (un-signalized)	Full Movement⁵	None.
70 (13)	29.592	East	Gated Field Access	Open Field	Full movement (un-signalized)	Closed	Access is secondary access to property and may be closed without condition.
Milepost 30							
71 (14)	30.237	East	East Palmer Divide Avenue	Transportation (Public Roadway)	Full movement (signalized)	Full Movement⁵	None.

1. The current State Highway Access Code shall govern any unresolved discrepancies regarding access decisions.

2. All access points are subject to consolidation upon the combining or subdividing of any lots under a single ownership or controlling interest.

3. All access locations +/- 50 feet (0.01 mile) unless otherwise noted.

4. The type, number, and storage length of lanes may be determined by a separate traffic study to be completed at the time of the actual design and implementation of the access plan and to ensure that the design does not create operational and/or safety issues.

5. Full movement access with potential to become/remain signalized or change to other full movement control, such as a roundabout. The design of any intermediate/final intersection control changes will be completed under a separate study to ensure that the design complies with the recommendations of the access control plan and does not create operational and/or safety issues.

6. A $\frac{3}{4}$ movement configuration means that vehicles can turn right into the access, turn right out of the access, and turn left into the access.

Exhibit - D
Access Control Plan Table^{1,2}

Colorado State Highway 83 (El Paso County)

August 2021

Access # (Map #)	Milepost ³	Side of Road	Access Description	Existing Land Use	Existing Configuration	Ultimate Configuration	Notes/Conditions for Change ⁴
72 (14)	30.237	West	East Palmer Divide Avenue	Transportation (Public Roadway)	Full movement (signalized)	Full Movement⁵	None.

1. The current State Highway Access Code shall govern any unresolved discrepancies regarding access decisions.
2. All access points are subject to consolidation upon the combining or subdividing of any lots under a single ownership or controlling interest.
3. All access locations +/- 50 feet (0.01 mile) unless otherwise noted.
4. The type, number, and storage length of lanes may be determined by a separate traffic study to be completed at the time of the actual design and implementation of the access plan and to ensure that the design does not create operational and/or safety issues.
5. Full movement access with potential to become/remain signalized or change to other full movement control, such as a roundabout. The design of any intermediate/final intersection control changes will be completed under a separate study to ensure that the design complies with the recommendations of the access control plan and does not create operational and/or safety issues.
6. A 3/4 movement configuration means that vehicles can turn right into the access, turn right out of the access, and turn left into the access.

CO 83 Access Control Plan



Exhibit E

Maps

AUGUST 2021

Exhibit -E: Access Control Plan Maps
Colorado State Highway 83 (El Paso County)

August 2021

This page left blank intentionally.

Exhibit -E: Access Control Plan Maps

Colorado State Highway 83 (El Paso County)

August 2021



CO-83 Access Control Plan Page 1 of 14

0 200 400 800 Feet

Legend

- | | | | |
|--|--|--|--|
| | Milepoints | | Right-In, Right-Out |
| | Parcels | | Emergency Access Only |
| | Full Movement (Signalized or Potential Roundabout) | | Right-In Only |
| | Full Movement (Unsignalized) | | Proposed Cross/Shared Property Access* |
| | Access Closed | | Existing Cross/Shared Property Access* |
| | 3/4 Movement (No Left Out) | | Proposed Future Roadway |

Notes

1. The current State Highway Access Code shall govern any unresolved discrepancies regarding access decisions.
2. All access points are subject to consolidation upon the combining or subdividing of any lots under a single ownership or controlling interest.
3. All access locations +/- 50 feet (0.01 mile) unless otherwise noted.
4. The type, number, and storage length of lanes may be determined by a separate traffic study to be completed at the time of the actual design and implementation of the access plan and to ensure that the design does not create operational and/or safety issues.
5. Full movement access with potential to become/remains signalized or change to other full movement control, such as a roundabout. The design of any intermediate/final intersection control changes will be completed under a separate study to ensure that the design complies with the recommendations of the access control plan and does not create operational and/or safety issues.
6. A 3/4 movement configuration means that vehicles can turn right into the access, turn right out of the access, and turn left into the access.

*Arrows represent two properties that already have shared access or could have shared access in the future. The placement of the arrows in the figure are not meant to identify the location of any future shared access. The location of future shared access would be determined through a cooperative and public effort between the property owners and/or CDOT and the County.

Exhibit -E: Access Control Plan Maps

Colorado State Highway 83 (El Paso County)

August 2021



CO-83 Access Control Plan Page 2 of 14

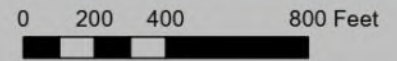

Legend

- | | | | |
|--|--|--|--|
| | Milepoints | | Right-In, Right-Out |
| | Parcels | | Emergency Access Only |
| | Full Movement (Signalized or Potential Roundabout) | | Right-In Only |
| | Full Movement (Unsignalized) | | Proposed Cross/Shared Property Access* |
| | Access Closed | | Existing Cross/Shared Property Access* |
| | 3/4 Movement (No Left Out) | | Proposed Future Roadway |

Notes

1. The current State Highway Access Code shall govern any unresolved discrepancies regarding access decisions.
2. All access points are subject to consolidation upon the combining or subdividing of any lots under a single ownership or controlling interest.
3. All access locations +/- 50 feet (0.01 mile) unless otherwise noted.
4. The type, number, and storage length of lanes may be determined by a separate traffic study to be completed at the time of the actual design and implementation of the access plan and to ensure that the design does not create operational and/or safety issues.
5. Full movement access with potential to become/remainsignalized or change to other full movement control, such as a roundabout. The design of any intermediate/final intersection control changes will be completed under a separate study to ensure that the design complies with the recommendations of the access control plan and does not create operational and/or safety issues.
6. A 3/4 movement configuration means that vehicles can turn right into the access, turn right out of the access, and turn left into the access.

*Arrows represent two properties that already have shared access or could have shared access in the future. The placement of the arrows in the figure are not meant to identify the location of any future shared access. The location of future shared access would be determined through a cooperative and public effort between the property owners and/or CDOT and the County.

Exhibit -E: Access Control Plan Maps

Colorado State Highway 83 (El Paso County)

August 2021



CO-83 Access Control Plan Page 3 of 14

0 200 400 800 Feet

Legend

- | | | | |
|--|--|--|--|
| | Milepoints | | Right-In, Right-Out |
| | Parcels | | Emergency Access Only |
| | Full Movement (Signalized or Potential Roundabout) | | Right-In Only |
| | Full Movement (Unsignalized) | | Proposed Cross/Shared Property Access* |
| | Access Closed | | Existing Cross/Shared Property Access* |
| | 3/4 Movement (No Left Out) | | Proposed Future Roadway |

Notes

1. The current State Highway Access Code shall govern any unresolved discrepancies regarding access decisions.
2. All access points are subject to consolidation upon the combining or subdividing of any lots under a single ownership or controlling interest.
3. All access locations +/- 50 feet (0.01 mile) unless otherwise noted.
4. The type, number, and storage length of lanes may be determined by a separate traffic study to be completed at the time of the actual design and implementation of the access plan and to ensure that the design does not create operational and/or safety issues.
5. Full movement access with potential to become/remain signalized or change to other full movement control, such as a roundabout. The design of any intermediate/final intersection control changes will be completed under a separate study to ensure that the design complies with the recommendations of the access control plan and does not create operational and/or safety issues.
6. A 3/4 movement configuration means that vehicles can turn right into the access, turn right out of the access, and turn left into the access.

*Arrows represent two properties that already have shared access or could have shared access in the future. The placement of the arrows in the figure are not meant to identify the location of a future shared access. The location of future shared access would be determined through a cooperative and public effort between the property owners and/or CDOT and the County.

Exhibit -E: Access Control Plan Maps

Colorado State Highway 83 (El Paso County)

August 2021



CO-83 Access Control Plan Page 4 of 14

0 200 400 800 Feet

Legend

- | | | | |
|--|--|--|--|
| | Milepoints | | Right-In, Right-Out |
| | Parcels | | Emergency Access Only |
| | Full Movement (Signalized or Potential Roundabout) | | Right-In Only |
| | Full Movement (Unsignalized) | | Proposed Cross/Shared Property Access* |
| | Access Closed | | Existing Cross/Shared Property Access* |
| | 3/4 Movement (No Left Out) | | Proposed Future Roadway |

Notes

1. The current State Highway Access Code shall govern any unresolved discrepancies regarding access decisions.
2. All access points are subject to consolidation upon the combining or subdividing of any lots under a single ownership or controlling interest.
3. All access locations +/- 50 feet (0.01 mile) unless otherwise noted.
4. The type, number, and storage length of lanes may be determined by a separate traffic study to be completed at the time of the actual design and implementation of the access plan and to ensure that the design does not create operational and/or safety issues.
5. Full movement access with potential to become/remain signalized or change to other full movement control, such as a roundabout. The design of any intermediate/final intersection control changes will be completed under a separate study to ensure that the design complies with the recommendations of the access control plan and does not create operational and/or safety issues.
6. A 3/4 movement configuration means that vehicles can turn right into the access, turn right out of the access, and turn left into the access.

*Arrows represent two properties that already have shared access or could have shared access in the future. The placement of the arrows in the figure are not meant to identify the location of any future shared access. The location of future shared access would be determined through a cooperative and public effort between the property owners and/or CDOT and the County.

Exhibit -E: Access Control Plan Maps

Colorado State Highway 83 (El Paso County)

August 2021



CO-83 Access Control Plan Page 5 of 14

0 200 400 800 Feet

Legend

- | | | | |
|--|--|--|--|
| | Milepoints | | Right-In, Right-Out |
| | Parcels | | Emergency Access Only |
| | Full Movement (Signalized or Potential Roundabout) | | Right-In Only |
| | Full Movement (Unsignalized) | | Proposed Cross/Shared Property Access* |
| | Access Closed | | Existing Cross/Shared Property Access* |
| | 3/4 Movement (No Left Out) | | Proposed Future Roadway |

Notes

1. The current State Highway Access Code shall govern any unresolved discrepancies regarding access decisions.
2. All access points are subject to consolidation upon the combining or subdividing of any lots under a single ownership or controlling interest.
3. All access locations +/- 50 feet (0.01 mile) unless otherwise noted.
4. The type, number, and storage length of lanes may be determined by a separate traffic study to be completed at the time of the actual design and implementation of the access plan and to ensure that the design does not create operational and/or safety issues.
5. Full movement access with potential to become/remain signalized or change to other full movement control, such as a roundabout. The design of any intermediate/final intersection control changes will be completed under a separate study to ensure that the design complies with the recommendations of the access control plan and does not create operational and/or safety issues.
6. A 3/4 movement configuration means that vehicles can turn right into the access, turn right out of the access, and turn left into the access.

*Arrows represent two properties that already have shared access or could have shared access in the future. The placement of the arrows in the figure are not meant to identify the location of any future shared access. The location of future shared access would be determined through a cooperative and public effort between the property owners and/or CDOT and the County.

Exhibit -E: Access Control Plan Maps

Colorado State Highway 83 (El Paso County)

August 2021

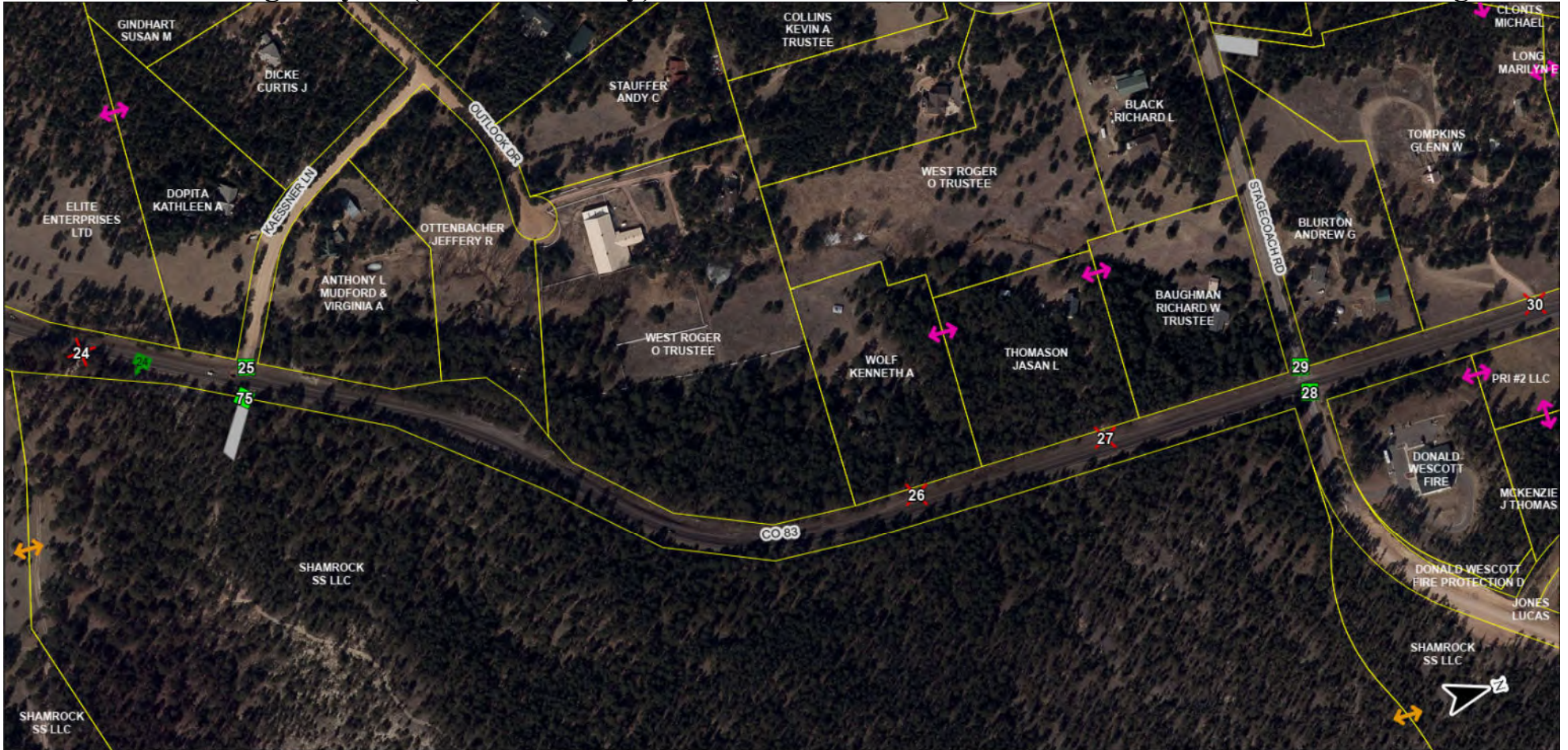

CO-83 Access Control Plan Page 6 of 14

0 200 400 800 Feet

Legend

- | | | | |
|--|--|--|--|
| | Milepoints | | Right-In, Right-Out |
| | Parcels | | Emergency Access Only |
| | Full Movement (Signalized or Potential Roundabout) | | Right-In Only |
| | Full Movement (Unsignalized) | | Proposed Cross/Shared Property Access* |
| | Access Closed | | Existing Cross/Shared Property Access* |
| | 3/4 Movement (No Left Out) | | Proposed Future Roadway |

Notes

1. The current State Highway Access Code shall govern any unresolved discrepancies regarding access decisions.
2. All access points are subject to consolidation upon the combining or subdividing of any lots under a single ownership or controlling interest.
3. All access locations +/- 50 feet (0.01 mile) unless otherwise noted.
4. The type, number, and storage length of lanes may be determined by a separate traffic study to be completed at the time of the actual design and implementation of the access plan and to ensure that the design does not create operational and/or safety issues.
5. Full movement access with potential to become/remain signalized or change to other full movement control, such as a roundabout. The design of any intermediate/final intersection control changes will be completed under a separate study to ensure that the design complies with the recommendations of the access control plan and does not create operational and/or safety issues.
6. A 3/4 movement configuration means that vehicles can turn right into the access, turn right out of the access, and turn left into the access.

*Arrows represent two properties that already have shared access or could have shared access in the future. The placement of the arrows in the figure are not meant to identify the location of any future shared access. The location of future shared access would be determined through a cooperative and public effort between the property owners and/or CDOT and the County.

Exhibit -E: Access Control Plan Maps

Colorado State Highway 83 (El Paso County)

August 2021



CO-83 Access Control Plan Page 7 of 14

0 200 400 800 Feet

Legend

- | | | | |
|--|--|--|--|
| | Milepoints | | Right-In, Right-Out |
| | Parcels | | Emergency Access Only |
| | Full Movement (Signalized or Potential Roundabout) | | Right-In Only |
| | Full Movement (Unsignalized) | | Proposed Cross/Shared Property Access* |
| | Access Closed | | Existing Cross/Shared Property Access* |
| | 3/4 Movement (No Left Out) | | Proposed Future Roadway |

Notes

1. The current State Highway Access Code shall govern any unresolved discrepancies regarding access decisions.
2. All access points are subject to consolidation upon the combining or subdividing of any lots under a single ownership or controlling interest.
3. All access locations +/- 50 feet (0.01 mile) unless otherwise noted.
4. The type, number, and storage length of lanes may be determined by a separate traffic study to be completed at the time of the actual design and implementation of the access plan and to ensure that the design does not create operational and/or safety issues.
5. Full movement access with potential to become/remain signalized or change to other full movement control, such as a roundabout. The design of any intermediate/final intersection control changes will be completed under a separate study to ensure that the design complies with the recommendations of the access control plan and does not create operational and/or safety issues.
6. A 3/4 movement configuration means that vehicles can turn right into the access, turn right out of the access, and turn left into the access.

*Arrows represent two properties that already have shared access or could have shared access in the future. The placement of the arrows in the figure are not meant to identify the location of any future shared access. The location of future shared access would be determined through a cooperative and public effort between the property owners and/or CDOT and the County.

Exhibit -E: Access Control Plan Maps

Colorado State Highway 83 (El Paso County)

August 2021

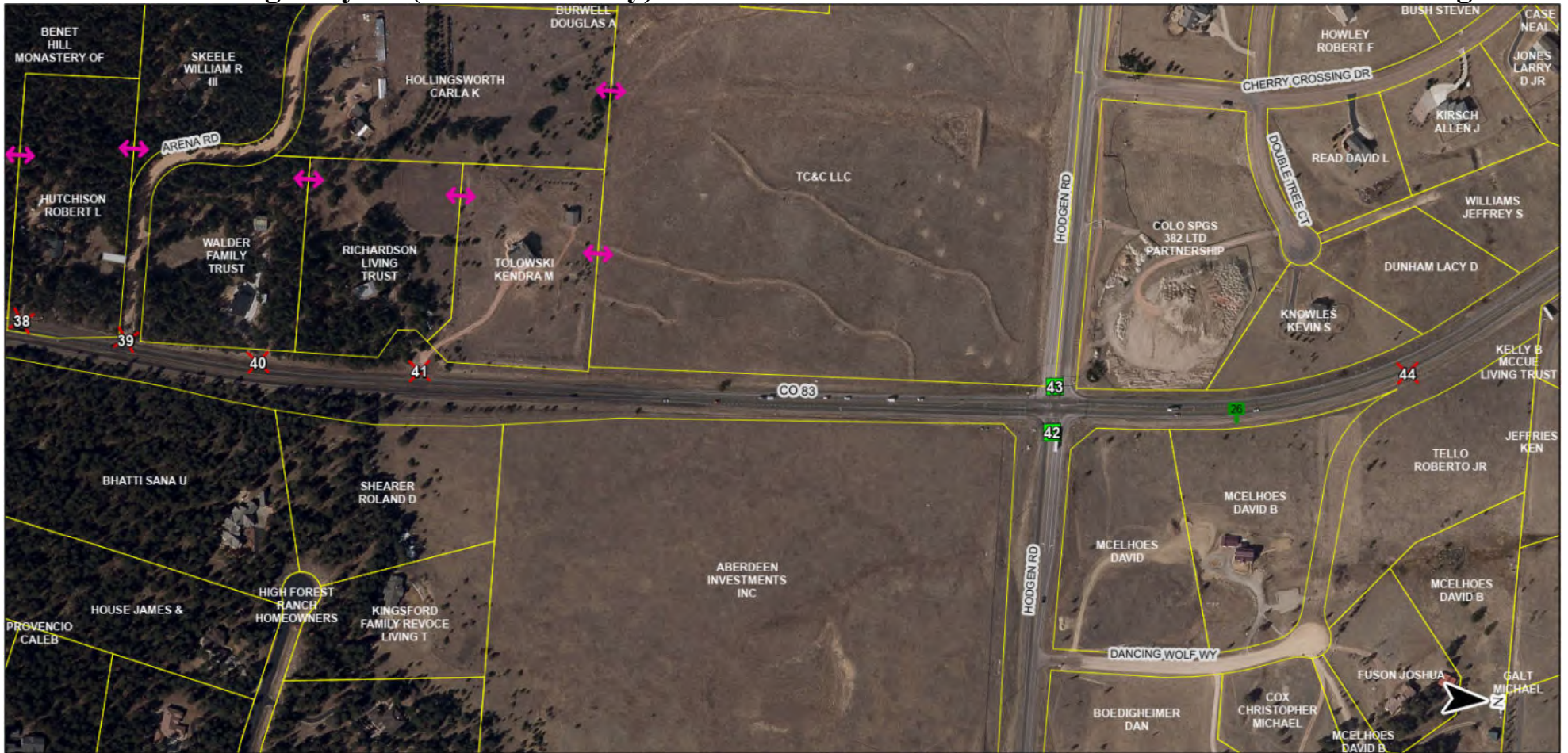

CO-83 Access Control Plan Page 8 of 14

0 200 400 800 Feet

Legend

- | | | | |
|--|--|--|--|
| | Milepoints | | Right-In, Right-Out |
| | Parcels | | Emergency Access Only |
| | Full Movement (Signalized or Potential Roundabout) | | Right-In Only |
| | Full Movement (Unsignalized) | | Proposed Cross/Shared Property Access* |
| | Access Closed | | Existing Cross/Shared Property Access* |
| | 3/4 Movement (No Left Out) | | Proposed Future Roadway |

Notes

1. The current State Highway Access Code shall govern any unresolved discrepancies regarding access decisions.
2. All access points are subject to consolidation upon the combining or subdividing of any lots under a single ownership or controlling interest.
3. All access locations +/- 50 feet (0.01 mile) unless otherwise noted.
4. The type, number, and storage length of lanes may be determined by a separate traffic study to be completed at the time of the actual design and implementation of the access plan and to ensure that the design does not create operational and/or safety issues.
5. Full movement access with potential to become/remains signalized or change to other full movement control, such as a roundabout. The design of any intermediate/final intersection control changes will be completed under a separate study to ensure that the design complies with the recommendations of the access control plan and does not create operational and/or safety issues.
6. A 3/4 movement configuration means that vehicles can turn right into the access, turn right out of the access, and turn left into the access.

*Arrows represent two properties that already have shared access or could have shared access in the future. The placement of the arrows in the figure are not meant to identify the location of any future shared access. The location of future shared access would be determined through a cooperative and public effort between the property owners and/or CDOT and the County.

Exhibit -E: Access Control Plan Maps

Colorado State Highway 83 (El Paso County)













August 2021



CO-83 Access Control Plan Page 9 of 14

0 200 400 800 Feet

Legend

- | | | | |
|--|--|---|--|
|  | Milepoints |  | Right-In, Right-Out |
|  | Parcels |  | Emergency Access Only |
|  | Full Movement (Signalized or Potential Roundabout) |  | Right-In Only |
|  | Full Movement (Unsignalized) |  | Proposed Cross/Shared Property Access* |
|  | Access Closed |  | Existing Cross/Shared Property Access* |
|  | 3/4 Movement (No Left Out) |  | Proposed Future Roadway |

Notes

1. The current State Highway Access Code shall govern any unresolved discrepancies regarding access decisions.
2. All access points are subject to consolidation upon the combining or subdividing of any lots under a single ownership or controlling interest.
3. All access locations +/- 50 feet (0.01 mile) unless otherwise noted.
4. The type, number, and storage length of lanes may be determined by a separate traffic study to be completed at the time of the actual design and implementation of the access plan and to ensure that the design does not create operational and/or safety issues.
5. Full movement access with potential to become/remain signalized or change to other full movement control, such as a roundabout. The design of any intermediate/final intersection control changes will be completed under a separate study to ensure that the design complies with the recommendations of the access control plan and does not create operational and/or safety issues.
6. A 3/4 movement configuration means that vehicles can turn right into the access, turn right out of the access, and turn left into the access.

*Arrows represent two properties that already have shared access or could have shared access in the future. The placement of the arrows in the figure are not meant to identify the location of any future shared access. The location of future shared access would be determined through a cooperative and public effort between the property owners and/or CDOT and the County.

Exhibit -E: Access Control Plan Maps

Colorado State Highway 83 (El Paso County)

August 2021



CO-83 Access Control Plan Page 10 of 14

0 200 400 800 Feet

Legend

- | | | | |
|--|--|--|--|
| | Milepoints | | Right-In, Right-Out |
| | Parcels | | Emergency Access Only |
| | Full Movement (Signalized or Potential Roundabout) | | Right-In Only |
| | Full Movement (Unsignalized) | | Proposed Cross/Shared Property Access* |
| | Access Closed | | Existing Cross/Shared Property Access* |
| | 3/4 Movement (No Left Out) | | Proposed Future Roadway |

Notes

1. The current State Highway Access Code shall govern any unresolved discrepancies regarding access decisions.
2. All access points are subject to consolidation upon the combining or subdividing of any lots under a single ownership or controlling interest.
3. All access locations +/- 50 feet (0.01 mile) unless otherwise noted.
4. The type, number, and storage length of lanes may be determined by a separate traffic study to be completed at the time of the actual design and implementation of the access plan and to ensure that the design does not create operational and/or safety issues.
5. Full movement access with potential to become/remain signalized or change to other full movement control, such as a roundabout. The design of any intermediate/final intersection control changes will be completed under a separate study to ensure that the design complies with the recommendations of the access control plan and does not create operational and/or safety issues.
6. A 3/4 movement configuration means that vehicles can turn right into the access, turn right out of the access, and turn left into the access.

*Arrows represent two properties that already have shared access or could have shared access in the future. The placement of the arrows in the figure are not meant to identify the location of any future shared access. The location of future shared access would be determined through a cooperative and public effort between the property owners and/or CDOT and the County.

Exhibit -E: Access Control Plan Maps

Colorado State Highway 83 (El Paso County)

August 2021



CO-83 Access Control Plan Page 11 of 14

0 200 400 800 Feet

Legend

- | | | | |
|--|--|--|--|
| | Milepoints | | Right-In, Right-Out |
| | Parcels | | Emergency Access Only |
| | Full Movement (Signalized or Potential Roundabout) | | Right-In Only |
| | Full Movement (Unsignalized) | | Proposed Cross/Shared Property Access* |
| | Access Closed | | Existing Cross/Shared Property Access* |
| | 3/4 Movement (No Left Out) | | Proposed Future Roadway |

Notes

1. The current State Highway Access Code shall govern any unresolved discrepancies regarding access decisions.
2. All access points are subject to consolidation upon the combining or subdividing of any lots under a single ownership or controlling interest.
3. All access locations +/- 50 feet (0.01 mile) unless otherwise noted.
4. The type, number, and storage length of lanes may be determined by a separate traffic study to be completed at the time of the actual design and implementation of the access plan and to ensure that the design does not create operational and/or safety issues.
5. Full movement access with potential to become/remainsignalized or change to other full movement control, such as a roundabout. The design of any intermediate/final intersection control changes will be completed under a separate study to ensure that the design complies with the recommendations of the access control plan and does not create operational and/or safety issues.
6. A 3/4 movement configuration means that vehicles can turn right into the access, turn right out of the access, and turn left into the access.

*Arrows represent two properties that already have shared access or could have shared access in the future. The placement of the arrows in the figure are not meant to identify the location of any future shared access. The location of future shared access would be determined through a cooperative and public effort between the property owners and/or CDOT and the County.

Exhibit -E: Access Control Plan Maps

Colorado State Highway 83 (El Paso County)

August 2021



CO-83 Access Control Plan Page 12 of 14

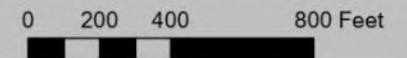

Legend

- | | | | |
|--|--|--|--|
| | Milepoints | | Right-In, Right-Out |
| | Parcels | | Emergency Access Only |
| | Full Movement (Signalized or Potential Roundabout) | | Right-In Only |
| | Full Movement (Unsignalized) | | Proposed Cross/Shared Property Access* |
| | Access Closed | | Existing Cross/Shared Property Access* |
| | 3/4 Movement (No Left Out) | | Proposed Future Roadway |

Notes

1. The current State Highway Access Code shall govern any unresolved discrepancies regarding access decisions.
 2. All access points are subject to consolidation upon the combining or subdividing of any lots under a single ownership or controlling interest.
 3. All access locations +/- 50 feet (0.01 mile) unless otherwise noted.
 4. The type, number, and storage length of lanes may be determined by a separate traffic study to be completed at the time of the actual design and implementation of the access plan and to ensure that the design does not create operational and/or safety issues.
 5. Full movement access with potential to become/remain signalized or change to other full movement control, such as a roundabout. The design of any intermediate/final intersection control changes will be completed under a separate study to ensure that the design complies with the recommendations of the access control plan and does not create operational and/or safety issues.
 6. A 3/4 movement configuration means that vehicles can turn right into the access, turn right out of the access, and turn left into the access.
- *Arrows represent two properties that already have shared access or could have shared access in the future. The placement of the arrows in the figure are not meant to identify the location of any future shared access. The location of future shared access would be determined through a cooperative and public effort between the property owners and/or CDOT and the County.

Exhibit -E: Access Control Plan Maps

Colorado State Highway 83 (El Paso County)

August 2021



CO-83 Access Control Plan Page 13 of 14

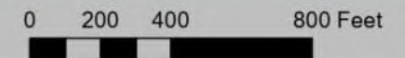

Legend

- | | | | |
|--|--|--|--|
| | Milepoints | | Right-In, Right-Out |
| | Parcels | | Emergency Access Only |
| | Full Movement (Signalized or Potential Roundabout) | | Right-In Only |
| | Full Movement (Unsignalized) | | Proposed Cross/Shared Property Access* |
| | Access Closed | | Existing Cross/Shared Property Access* |
| | 3/4 Movement (No Left Out) | | Proposed Future Roadway |

Notes

1. The current State Highway Access Code shall govern any unresolved discrepancies regarding access decisions.
2. All access points are subject to consolidation upon the combining or subdividing of any lots under a single ownership or controlling interest.
3. All access locations +/- 50 feet (0.01 mile) unless otherwise noted.
4. The type, number, and storage length of lanes may be determined by a separate traffic study to be completed at the time of the actual design and implementation of the access plan and to ensure that the design does not create operational and/or safety issues.
5. Full movement access with potential to become/remains signalized or change to other full movement control, such as a roundabout. The design of any intermediate/final intersection control changes will be completed under a separate study to ensure that the design complies with the recommendations of the access control plan and does not create operational and/or safety issues.
6. A 3/4 movement configuration means that vehicles can turn right into the access, turn right out of the access, and turn left into the access.

*Arrows represent two properties that already have shared access or could have shared access in the future. The placement of the arrows in the figure are not meant to identify the location of any future shared access. The location of future shared access would be determined through a cooperative and public effort between the property owners and/or CDOT and the County.

Exhibit -E: Access Control Plan Maps

Colorado State Highway 83 (El Paso County)

August 2021



CO-83 Access Control Plan Page 14 of 14

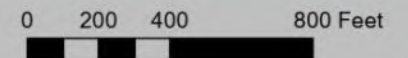

Legend

- | | | | |
|--|--|--|--|
| | Milepoints | | Right-In, Right-Out |
| | Parcels | | Emergency Access Only |
| | Full Movement (Signalized or Potential Roundabout) | | Right-In Only |
| | Full Movement (Unsignalized) | | Proposed Cross/Shared Property Access* |
| | Access Closed | | Existing Cross/Shared Property Access* |
| | 3/4 Movement (No Left Out) | | Proposed Future Roadway |

Notes

1. The current State Highway Access Code shall govern any unresolved discrepancies regarding access decisions.
 2. All access points are subject to consolidation upon the combining or subdividing of any lots under a single ownership or controlling interest.
 3. All access locations +/- 50 feet (0.01 mile) unless otherwise noted.
 4. The type, number, and storage length of lanes may be determined by a separate traffic study to be completed at the time of the actual design and implementation of the access plan and to ensure that the design does not create operational and/or safety issues.
 5. Full movement access with potential to become/remains signalized or change to other full movement control, such as a roundabout. The design of any intermediate/final intersection control changes will be completed under a separate study to ensure that the design complies with the recommendations of the access control plan and does not create operational and/or safety issues.
 6. A 3/4 movement configuration means that vehicles can turn right into the access, turn right out of the access, and turn left into the access.
- *Arrows represent two properties that already have shared access or could have shared access in the future. The placement of the arrows in the figure are not meant to identify the location of any future shared access. The location of future shared access would be determined through a cooperative and public effort between the property owners and/or CDOT and the County.

This page intentionally left blank.

Appendix B. Existing Traffic Data

B.1. Average Daily Traffic Volumes

All Traffic Data Services, LLC
www.alltrafficdata.net

Date Start: 15-Sep-20
Site Code: 8
Station ID: 8
CO-83 S.O. SHOUP RD

NB

Start Time	Bikes	Cars & Trailers	2 Axle Long	Buses	2 Axle 6 Tire	3 Axle Single	4 Axle Single	<5 Axl Double	5 Axle Double	>6 Axl Double	<6 Axl Multi	6 Axle Multi	>6 Axl Multi	Total
09/15/20	0	12	0	0	0	0	0	0	1	0	0	0	0	13
01:00	0	13	0	0	1	0	0	1	1	0	0	0	0	16
02:00	0	17	0	0	1	1	0	0	1	0	0	0	0	20
03:00	0	49	5	0	0	0	0	0	3	0	0	0	0	57
04:00	0	153	16	0	1	4	0	2	3	0	0	0	0	179
05:00	0	391	47	0	8	3	2	3	7	3	1	2	2	469
06:00	3	532	74	1	16	11	9	8	8	8	0	2	3	675
07:00	1	499	71	0	8	15	10	12	11	6	1	2	1	637
08:00	3	615	72	2	9	7	4	9	7	1	0	5	1	735
09:00	3	551	78	3	8	7	4	6	3	4	0	0	2	669
10:00	4	708	71	0	6	7	6	4	6	12	0	1	2	827
11:00	7	694	75	0	5	9	6	12	6	2	0	2	0	818
12 PM	4	708	62	0	9	12	8	8	8	3	0	3	2	827
13:00	4	785	89	0	26	6	12	11	4	5	1	0	1	944
14:00	7	951	134	0	4	7	10	5	3	16	0	7	2	1146
15:00	8	1030	117	5	6	12	7	9	4	10	0	4	3	1215
16:00	8	1133	129	1	5	10	9	10	4	14	1	2	0	1326
17:00	5	824	88	0	1	7	9	8	6	7	0	0	1	956
18:00	2	522	52	0	1	0	5	1	0	5	0	1	0	589
19:00	0	378	31	0	2	0	3	3	1	2	0	2	1	423
20:00	0	226	13	0	0	0	1	0	1	0	0	0	0	241
21:00	0	128	5	0	0	0	0	0	1	0	0	0	0	134
22:00	1	78	2	0	1	0	0	0	0	0	0	0	0	82
23:00	0	30	1	0	0	0	0	0	1	1	0	0	0	33
Day Total	60	11027	1232	12	118	118	105	112	90	99	4	33	21	13031
Percent	0.5%	84.6%	9.5%	0.1%	0.9%	0.9%	0.8%	0.9%	0.7%	0.8%	0.0%	0.3%	0.2%	
AM Peak	11:00	10:00	09:00	09:00	06:00	07:00	07:00	07:00	07:00	10:00	05:00	08:00	06:00	10:00
Vol.	7	708	78	3	16	15	10	12	11	12	1	5	3	827
PM Peak	15:00	16:00	14:00	15:00	13:00	12:00	13:00	13:00	12:00	14:00	13:00	14:00	15:00	16:00
Vol.	8	1133	134	5	26	12	12	11	8	16	1	7	3	1326
Grand Total	60	11027	1232	12	118	118	105	112	90	99	4	33	21	13031
Percent	0.5%	84.6%	9.5%	0.1%	0.9%	0.9%	0.8%	0.9%	0.7%	0.8%	0.0%	0.3%	0.2%	

All Traffic Data Services, LLC
www.alltrafficdata.net

Date Start: 15-Sep-20
Site Code: 8
Station ID: 8
CO-83 S.O. SHOUP RD

SB

Start Time	Bikes	Cars & Trailers	2 Axle Long	Buses	2 Axle 6 Tire	3 Axle Single	4 Axle Single	<5 Axl Double	5 Axle Double	>6 Axl Double	<6 Axl Multi	6 Axle Multi	>6 Axl Multi	Total
09/15/20	1	13	0	0	0	0	0	0	1	0	0	0	0	15
01:00	1	15	0	0	0	0	0	0	0	0	0	0	0	16
02:00	0	19	0	0	1	0	0	0	0	0	0	0	0	20
03:00	0	53	2	0	0	1	0	0	1	0	0	0	0	57
04:00	1	176	1	0	0	0	0	0	1	0	0	0	0	179
05:00	5	457	2	0	0	1	0	1	3	0	0	0	0	469
06:00	13	833	40	0	3	4	8	0	5	5	0	3	0	914
07:00	14	675	114	2	5	9	7	4	8	15	0	1	2	856
08:00	11	582	92	0	9	8	9	3	7	12	0	1	1	735
09:00	6	548	64	0	11	14	2	7	8	8	0	0	1	669
10:00	1	711	63	1	6	15	7	4	6	8	0	3	2	827
11:00	3	724	48	0	6	11	4	3	7	8	0	1	3	818
12 PM	2	695	79	0	6	13	8	8	4	7	0	4	1	827
13:00	1	832	68	0	6	7	8	4	5	9	1	2	1	944
14:00	3	996	86	0	8	13	9	3	7	11	2	5	3	1146
15:00	2	1058	98	0	11	10	8	8	7	9	1	3	0	1215
16:00	2	1304	110	2	6	10	14	7	4	11	1	6	2	1479
17:00	4	888	116	3	7	9	8	4	3	8	0	6	2	1058
18:00	8	457	81	3	2	8	13	2	6	5	0	1	3	589
19:00	9	342	48	0	0	7	4	1	4	5	1	0	2	423
20:00	1	222	8	1	2	1	0	0	4	1	0	0	1	241
21:00	2	126	2	0	0	0	1	0	2	1	0	0	0	134
22:00	2	76	1	0	1	0	0	1	1	0	0	0	0	82
23:00	0	31	1	0	0	0	0	0	1	0	0	0	0	33
Day Total	92	11833	1124	12	90	141	110	60	95	123	6	36	24	13746
Percent	0.7%	86.1%	8.2%	0.1%	0.7%	1.0%	0.8%	0.4%	0.7%	0.9%	0.0%	0.3%	0.2%	
AM Peak	07:00	06:00	07:00	07:00	09:00	10:00	08:00	09:00	07:00	07:00		06:00	11:00	06:00
Vol.	14	833	114	2	11	15	9	7	8	15		3	3	914
PM Peak	19:00	16:00	17:00	17:00	15:00	12:00	16:00	12:00	14:00	14:00	14:00	16:00	14:00	16:00
Vol.	9	1304	116	3	11	13	14	8	7	11	2	6	3	1479
Grand Total	92	11833	1124	12	90	141	110	60	95	123	6	36	24	13746
Percent	0.7%	86.1%	8.2%	0.1%	0.7%	1.0%	0.8%	0.4%	0.7%	0.9%	0.0%	0.3%	0.2%	

All Traffic Data Services, LLC
www.alltrafficdata.net

Date Start: 15-Sep-20
Site Code: 8
Station ID: 8
CO-83 S.O. SHOUP RD

Start Time	15-Sep-20 Tue	NB	SB	Total						
12:00 AM		13	15	28						
01:00		16	16	32						
02:00		20	20	40						
03:00		57	57	114						
04:00		179	179	358						
05:00		469	469	938						
06:00		675	914	1589						
07:00		637	856	1493						
08:00		735	735	1470						
09:00		669	669	1338						
10:00		827	827	1654						
11:00		818	818	1636						
12:00 PM		827	827	1654						
01:00		944	944	1888						
02:00		1146	1146	2292						
03:00		1215	1215	2430						
04:00		1326	1479	2805						
05:00		956	1058	2014						
06:00		589	589	1178						
07:00		423	423	846						
08:00		241	241	482						
09:00		134	134	268						
10:00		82	82	164						
11:00		33	33	66						
Total		13031	13746	26777						
Percent		48.7%	51.3%							
AM Peak	-	10:00	06:00	-	-	-	-	-	-	10:00
Vol.	-	827	914	-	-	-	-	-	-	1654
PM Peak	-	16:00	16:00	-	-	-	-	-	-	16:00
Vol.	-	1326	1479	-	-	-	-	-	-	2805
Grand Total		13031	13746							26777
Percent		48.7%	51.3%							
ADT		ADT 26,777	AADT 26,777							

All Traffic Data Services, LLC
www.alltrafficdata.net

Date Start: 15-Sep-20
Site Code: 9
Station ID: 9
CO-83 S.O. NORTH GATE BLVD

NB

Start Time	Bikes	Cars & Trailers	2 Axle Long	Buses	2 Axle 6 Tire	3 Axle Single	4 Axle Single	<5 Axl Double	5 Axle Double	>6 Axl Double	<6 Axl Multi	6 Axle Multi	>6 Axl Multi	Total
09/15/20	0	30	8	0	0	0	0	0	2	2	0	0	0	42
01:00	0	18	0	0	0	0	0	0	0	0	0	0	0	18
02:00	0	16	2	0	0	2	0	2	2	0	0	0	0	24
03:00	0	11	2	0	0	0	0	0	0	0	0	0	0	13
04:00	0	36	4	1	0	1	0	0	5	0	0	0	0	47
05:00	1	101	13	1	0	4	0	0	7	0	0	0	0	127
06:00	0	481	37	0	0	2	0	0	8	0	0	0	0	528
07:00	3	690	80	0	9	5	2	0	9	0	0	0	0	798
08:00	1	615	80	0	7	13	1	6	17	0	0	0	0	740
09:00	3	610	73	0	6	16	0	2	14	0	0	2	0	726
10:00	3	574	81	0	13	6	1	3	10	0	0	0	0	691
11:00	2	586	62	0	2	8	0	2	6	2	0	0	0	670
12 PM	4	673	84	0	9	9	0	0	23	1	0	2	0	805
13:00	2	683	82	0	8	6	0	0	5	2	0	0	0	788
14:00	3	749	84	0	11	10	0	5	4	1	0	0	0	867
15:00	6	833	99	0	6	9	0	5	13	1	0	0	4	976
16:00	4	913	99	0	5	7	2	0	5	2	0	2	2	1041
17:00	5	913	112	0	9	9	0	4	9	1	0	2	0	1064
18:00	3	675	92	0	4	9	0	1	3	3	0	0	0	790
19:00	5	475	78	0	2	4	0	1	2	3	0	0	0	570
20:00	4	367	56	0	1	0	0	0	1	0	0	0	0	429
21:00	1	200	28	0	2	0	0	0	6	2	0	0	0	239
22:00	1	110	20	0	1	0	0	0	0	0	0	0	0	132
23:00	0	77	17	0	2	0	0	0	2	0	0	0	0	98
Day Total	51	10436	1293	2	97	120	6	31	153	20	0	8	6	12223
Percent	0.4%	85.4%	10.6%	0.0%	0.8%	1.0%	0.0%	0.3%	1.3%	0.2%	0.0%	0.1%	0.0%	
AM Peak	07:00	07:00	10:00	04:00	10:00	09:00	07:00	08:00	08:00	00:00		09:00		07:00
Vol.	3	690	81	1	13	16	2	6	17	2		2		798
PM Peak	15:00	16:00	17:00		14:00	14:00	16:00	14:00	12:00	18:00		12:00	15:00	17:00
Vol.	6	913	112		11	10	2	5	23	3		2	4	1064
Grand Total	51	10436	1293	2	97	120	6	31	153	20	0	8	6	12223
Percent	0.4%	85.4%	10.6%	0.0%	0.8%	1.0%	0.0%	0.3%	1.3%	0.2%	0.0%	0.1%	0.0%	

All Traffic Data Services, LLC
www.alltrafficdata.net

Date Start: 15-Sep-20
Site Code: 9
Station ID: 9
CO-83 S.O. NORTH GATE BLVD

SB

Start Time	Bikes	Cars & Trailers	2 Axle Long	Buses	2 Axle 6 Tire	3 Axle Single	4 Axle Single	<5 Axl Double	5 Axle Double	>6 Axl Double	<6 Axl Multi	6 Axle Multi	>6 Axl Multi	Total
09/15/20	0	16	0	0	0	0	0	0	0	0	0	0	0	16
01:00	0	6	0	0	0	0	0	0	0	0	0	0	0	6
02:00	0	10	3	0	0	0	0	0	2	0	0	0	0	15
03:00	0	45	2	0	0	0	0	0	1	0	0	0	0	48
04:00	0	178	7	0	0	2	0	0	4	0	0	0	0	191
05:00	5	479	29	0	1	4	3	2	2	4	0	1	1	531
06:00	5	671	74	1	3	6	5	3	1	10	0	0	2	781
07:00	3	586	90	0	4	5	6	11	3	6	0	0	2	716
08:00	8	564	53	0	3	9	6	5	4	6	1	2	0	661
09:00	7	620	71	1	5	7	8	3	4	7	1	1	2	737
10:00	1	590	56	0	7	17	5	3	5	2	3	0	1	690
11:00	1	617	60	0	8	6	7	2	2	2	0	1	0	706
12 PM	3	595	69	0	1	3	9	4	4	4	0	1	1	694
13:00	4	749	74	1	9	4	7	6	11	9	0	3	0	877
14:00	6	845	104	3	8	11	6	7	6	6	0	2	0	1004
15:00	2	869	114	2	7	6	11	8	8	6	1	5	1	1040
16:00	6	1023	110	0	6	4	6	4	1	4	1	3	0	1168
17:00	7	819	95	4	3	4	9	8	5	10	0	1	1	966
18:00	3	535	36	0	0	5	5	6	5	5	0	1	2	603
19:00	2	266	16	0	1	0	1	0	4	2	0	0	0	292
20:00	2	152	2	0	0	0	0	0	2	0	0	1	0	159
21:00	0	92	5	0	1	0	0	1	0	1	0	0	0	100
22:00	0	39	0	0	0	0	0	1	0	0	0	0	0	40
23:00	0	21	0	0	0	0	0	0	1	0	0	0	0	22
Day Total	65	10387	1070	12	67	93	94	74	75	84	7	22	13	12063
Percent	0.5%	86.1%	8.9%	0.1%	0.6%	0.8%	0.8%	0.6%	0.6%	0.7%	0.1%	0.2%	0.1%	
AM Peak	08:00	06:00	07:00	06:00	11:00	10:00	09:00	07:00	10:00	06:00	10:00	08:00	06:00	06:00
Vol.	8	671	90	1	8	17	8	11	5	10	3	2	2	781
PM Peak	17:00	16:00	15:00	17:00	13:00	14:00	15:00	15:00	13:00	17:00	15:00	15:00	18:00	16:00
Vol.	7	1023	114	4	9	11	11	8	11	10	1	5	2	1168
Grand Total	65	10387	1070	12	67	93	94	74	75	84	7	22	13	12063
Percent	0.5%	86.1%	8.9%	0.1%	0.6%	0.8%	0.8%	0.6%	0.6%	0.7%	0.1%	0.2%	0.1%	

All Traffic Data Services, LLC
www.alltrafficdata.net

Date Start: 15-Sep-20
Site Code: 9
Station ID: 9
CO-83 S.O. NORTH GATE BLVD

Start Time	15-Sep-20 Tue	NB	SB	Total						
12:00 AM		42	16	58						
01:00		18	6	24						
02:00		24	15	39						
03:00		13	48	61						
04:00		47	191	238						
05:00		127	531	658						
06:00		528	781	1309						
07:00		798	716	1514						
08:00		740	661	1401						
09:00		726	737	1463						
10:00		691	690	1381						
11:00		670	706	1376						
12:00 PM		805	694	1499						
01:00		788	877	1665						
02:00		867	1004	1871						
03:00		976	1040	2016						
04:00		1041	1168	2209						
05:00		1064	966	2030						
06:00		790	603	1393						
07:00		570	292	862						
08:00		429	159	588						
09:00		239	100	339						
10:00		132	40	172						
11:00		98	22	120						
Total		12223	12063	24286						
Percent		50.3%	49.7%							
AM Peak	-	07:00	06:00	-	-	-	-	-	-	07:00
Vol.	-	798	781	-	-	-	-	-	-	1514
PM Peak	-	17:00	16:00	-	-	-	-	-	-	16:00
Vol.	-	1064	1168	-	-	-	-	-	-	2209
Grand Total		12223	12063							24286
Percent		50.3%	49.7%							
ADT		ADT 24,286	AADT 24,286							

All Traffic Data Services, LLC
www.alltrafficdata.net

Date Start: 15-Sep-20
Site Code: 23
Station ID: 23
CO-83 N.O. STAGECOACH RD

NB

Start Time	Bikes	Cars & Trailers	2 Axle Long	Buses	2 Axle 6 Tire	3 Axle Single	4 Axle Single	<5 Axl Double	5 Axle Double	>6 Axl Double	<6 Axl Multi	6 Axle Multi	>6 Axl Multi	Total
09/15/20	0	17	4	0	0	0	0	0	1	1	0	0	0	23
01:00	0	10	0	0	0	0	0	0	0	0	0	0	0	10
02:00	0	9	1	0	0	1	0	1	1	0	0	0	0	13
03:00	0	6	1	0	0	0	0	0	0	0	0	0	0	7
04:00	0	21	2	0	0	0	0	0	3	0	0	0	0	26
05:00	0	60	7	0	0	2	0	0	4	0	0	0	0	73
06:00	0	226	15	0	0	1	0	0	3	0	0	0	0	245
07:00	3	324	36	0	4	3	1	0	4	0	0	0	0	375
08:00	2	282	28	0	3	10	0	3	9	0	0	0	0	337
09:00	4	282	32	0	3	10	0	1	8	0	0	1	0	341
10:00	3	268	33	0	6	3	0	1	5	0	0	0	0	319
11:00	2	312	27	0	1	4	0	1	4	1	0	0	0	352
12 PM	4	359	43	0	5	5	0	0	14	0	0	1	0	431
13:00	3	363	43	0	4	3	0	0	3	2	0	0	0	421
14:00	4	399	44	0	6	5	0	2	2	0	0	0	0	462
15:00	6	459	55	0	2	4	0	2	7	0	0	0	2	537
16:00	6	563	58	0	2	4	1	0	3	1	0	1	1	640
17:00	7	564	66	0	4	5	0	2	5	1	0	1	0	655
18:00	5	394	54	0	2	5	0	0	2	1	0	0	0	463
19:00	5	277	46	0	1	2	0	0	0	1	0	0	0	332
20:00	4	215	33	0	1	0	0	0	0	0	0	0	0	253
21:00	1	117	16	0	1	0	0	0	3	1	0	0	0	139
22:00	1	64	11	0	0	0	0	0	0	0	0	0	0	76
23:00	0	45	9	0	1	0	0	0	1	0	0	0	0	56
Day Total	60	5636	664	0	46	67	2	13	82	9	0	4	3	6586
Percent	0.9%	85.6%	10.1%	0.0%	0.7%	1.0%	0.0%	0.2%	1.2%	0.1%	0.0%	0.1%	0.0%	
AM Peak	09:00	07:00	07:00		10:00	08:00	07:00	08:00	08:00	00:00		09:00		07:00
Vol.	4	324	36		6	10	1	3	9	1		1		375
PM Peak	17:00	17:00	17:00		14:00	12:00	16:00	14:00	12:00	13:00		12:00	15:00	17:00
Vol.	7	564	66		6	5	1	2	14	2		1	2	655
Grand Total	60	5636	664	0	46	67	2	13	82	9	0	4	3	6586
Percent	0.9%	85.6%	10.1%	0.0%	0.7%	1.0%	0.0%	0.2%	1.2%	0.1%	0.0%	0.1%	0.0%	

All Traffic Data Services, LLC
www.alltrafficdata.net

Date Start: 15-Sep-20
Site Code: 23
Station ID: 23
CO-83 N.O. STAGECOACH RD

SB

Start Time	Bikes	Cars & Trailers	2 Axle Long	Buses	2 Axle 6 Tire	3 Axle Single	4 Axle Single	<5 Axl Double	5 Axle Double	>6 Axl Double	<6 Axl Multi	6 Axle Multi	>6 Axl Multi	Total
09/15/20	0	19	0	0	0	0	0	0	0	0	0	0	0	19
01:00	0	13	0	0	0	0	0	0	0	0	0	0	0	13
02:00	0	2	0	0	0	0	0	0	0	0	0	0	0	2
03:00	0	6	1	0	0	2	0	0	0	0	0	0	0	9
04:00	0	25	1	0	0	1	0	0	1	0	0	0	0	28
05:00	0	107	12	0	0	3	0	0	0	0	0	0	0	122
06:00	0	362	29	0	0	6	0	0	0	0	0	0	0	397
07:00	1	531	51	0	0	3	0	0	1	0	0	0	0	587
08:00	1	385	75	1	0	5	0	0	0	0	0	0	0	467
09:00	1	357	78	0	0	15	0	1	1	0	0	0	0	453
10:00	0	394	53	0	0	12	0	0	4	0	0	0	0	463
11:00	1	327	53	0	2	11	0	0	3	0	0	0	0	397
12 PM	1	333	50	0	1	6	0	0	3	0	0	0	0	394
13:00	1	368	41	1	0	8	0	0	4	0	0	0	0	423
14:00	0	447	41	0	0	5	0	0	4	0	0	0	0	497
15:00	1	400	61	1	1	6	0	1	3	0	0	0	0	474
16:00	1	543	66	0	2	11	0	0	2	1	0	0	0	626
17:00	3	585	67	1	3	6	0	0	3	0	0	0	0	668
18:00	1	462	54	0	0	4	0	0	1	0	0	0	0	522
19:00	0	346	35	0	1	4	0	0	1	0	0	0	0	387
20:00	0	176	8	0	0	3	0	0	1	1	0	0	0	189
21:00	0	118	5	0	1	1	0	0	0	0	0	0	0	125
22:00	1	60	4	0	0	0	0	0	0	0	0	0	0	65
23:00	0	34	2	0	0	1	0	0	0	0	0	0	0	37
Day Total	13	6400	787	4	11	113	0	2	32	2	0	0	0	7364
Percent	0.2%	86.9%	10.7%	0.1%	0.1%	1.5%	0.0%	0.0%	0.4%	0.0%	0.0%	0.0%	0.0%	
AM Peak	07:00	07:00	09:00	08:00	11:00	09:00		09:00	10:00					07:00
Vol.	1	531	78	1	2	15		1	4					587
PM Peak	17:00	17:00	17:00	13:00	17:00	16:00		15:00	13:00	16:00				17:00
Vol.	3	585	67	1	3	11		1	4	1				668
Grand Total	13	6400	787	4	11	113	0	2	32	2	0	0	0	7364
Percent	0.2%	86.9%	10.7%	0.1%	0.1%	1.5%	0.0%	0.0%	0.4%	0.0%	0.0%	0.0%	0.0%	

All Traffic Data Services, LLC
www.alltrafficdata.net

Date Start: 15-Sep-20
Site Code: 23
Station ID: 23
CO-83 N.O. STAGECOACH RD

Start Time	15-Sep-20 Tue	NB	SB	Total						
12:00 AM		23	19	42						
01:00		10	13	23						
02:00		13	2	15						
03:00		7	9	16						
04:00		26	28	54						
05:00		73	122	195						
06:00		245	397	642						
07:00		375	587	962						
08:00		337	467	804						
09:00		341	453	794						
10:00		319	463	782						
11:00		352	397	749						
12:00 PM		431	394	825						
01:00		421	423	844						
02:00		462	497	959						
03:00		537	474	1011						
04:00		640	626	1266						
05:00		655	668	1323						
06:00		463	522	985						
07:00		332	387	719						
08:00		253	189	442						
09:00		139	125	264						
10:00		76	65	141						
11:00		56	37	93						
Total		6586	7364	13950						
Percent		47.2%	52.8%							
AM Peak	-	07:00	07:00	-	-	-	-	-	-	07:00
Vol.	-	375	587	-	-	-	-	-	-	962
PM Peak	-	17:00	17:00	-	-	-	-	-	-	17:00
Vol.	-	655	668	-	-	-	-	-	-	1323
Grand Total		6586	7364							13950
Percent		47.2%	52.8%							
ADT		ADT 13,950	AADT 13,950							

All Traffic Data Services, LLC
www.alltrafficdata.net

Date Start: 15-Sep-20
Site Code: 24
Station ID: 24
CO-83 N.O. HOGDEN RD

SB

Start Time	Bikes	Cars & Trailers	2 Axle Long	Buses	2 Axle 6 Tire	3 Axle Single	4 Axle Single	<5 Axl Double	5 Axle Double	>6 Axl Double	<6 Axl Multi	6 Axle Multi	>6 Axl Multi	Total
09/15/20	0	22	2	0	0	0	0	0	1	0	0	0	0	25
01:00	0	10	0	0	0	0	0	0	1	0	0	0	0	11
02:00	0	5	0	0	0	0	0	0	2	0	0	1	0	8
03:00	0	5	1	0	0	0	0	0	1	0	0	0	0	7
04:00	0	23	0	0	0	1	0	0	0	0	0	0	0	24
05:00	0	74	6	0	1	1	0	0	1	0	0	0	0	83
06:00	0	221	18	0	4	0	0	1	6	0	0	0	0	250
07:00	0	331	37	0	2	0	0	3	3	0	0	0	0	376
08:00	0	324	28	0	5	8	0	5	7	0	0	0	0	377
09:00	4	284	20	0	6	11	0	1	8	0	0	0	0	334
10:00	5	305	24	1	5	7	0	2	6	0	0	0	0	355
11:00	3	283	22	0	5	12	0	0	7	0	0	0	0	332
12 PM	3	308	15	0	8	4	0	0	2	0	0	0	0	340
13:00	7	307	27	0	1	1	0	0	4	1	0	0	0	348
14:00	8	443	35	0	7	8	0	1	11	0	0	0	0	513
15:00	6	458	44	1	9	10	0	1	6	1	0	0	0	536
16:00	10	632	47	0	4	12	0	0	8	1	0	0	0	714
17:00	9	661	63	0	5	5	0	1	6	1	0	0	0	751
18:00	5	580	45	0	4	5	0	3	2	3	0	1	0	648
19:00	4	362	27	0	2	2	0	1	8	0	0	0	0	406
20:00	3	187	15	0	0	1	0	0	3	1	0	0	0	210
21:00	0	119	2	0	0	0	0	0	2	0	0	0	0	123
22:00	0	76	5	0	1	0	0	1	0	1	0	0	0	84
23:00	0	30	0	0	0	0	0	0	2	0	0	0	0	32
Day Total	67	6050	483	2	69	88	0	20	97	9	0	2	0	6887
Percent	1.0%	87.8%	7.0%	0.0%	1.0%	1.3%	0.0%	0.3%	1.4%	0.1%	0.0%	0.0%	0.0%	
AM Peak	10:00	07:00	07:00	10:00	09:00	11:00		08:00	09:00			02:00		08:00
Vol.	5	331	37	1	6	12		5	8			1		377
PM Peak	16:00	17:00	17:00	15:00	15:00	16:00		18:00	14:00	18:00		18:00		17:00
Vol.	10	661	63	1	9	12		3	11	3		1		751
Grand Total	67	6050	483	2	69	88	0	20	97	9	0	2	0	6887
Percent	1.0%	87.8%	7.0%	0.0%	1.0%	1.3%	0.0%	0.3%	1.4%	0.1%	0.0%	0.0%	0.0%	

All Traffic Data Services, LLC
www.alltrafficdata.net

Date Start: 15-Sep-20
Site Code: 24
Station ID: 24
CO-83 N.O. HOGDEN RD

NB

Start Time	Bikes	Cars & Trailers	2 Axle Long	Buses	2 Axle 6 Tire	3 Axle Single	4 Axle Single	<5 Axl Double	5 Axle Double	>6 Axl Double	<6 Axl Multi	6 Axle Multi	>6 Axl Multi	Total
09/15/20	0	16	0	0	0	0	0	0	0	1	0	0	0	17
01:00	0	9	0	0	0	0	0	0	0	0	0	0	0	9
02:00	0	5	0	0	0	0	0	1	1	0	0	0	0	7
03:00	0	22	2	0	1	0	0	1	0	0	0	0	0	26
04:00	2	49	2	0	0	1	0	0	2	0	0	0	0	56
05:00	0	174	20	0	3	3	0	2	2	0	0	0	0	204
06:00	3	298	34	0	2	2	2	8	5	0	0	0	0	354
07:00	0	401	45	0	11	11	0	6	5	0	0	0	0	479
08:00	0	377	35	0	9	11	1	5	7	0	0	0	0	445
09:00	2	286	23	0	6	7	1	5	8	0	0	0	0	338
10:00	1	272	27	0	6	6	1	5	6	0	0	0	0	324
11:00	2	287	30	1	9	6	0	2	7	1	0	0	0	345
12 PM	6	322	24	0	6	5	0	1	11	0	0	0	0	375
13:00	3	304	15	0	9	4	0	0	4	1	0	0	0	340
14:00	1	351	27	1	7	4	1	1	2	0	0	1	0	396
15:00	4	451	28	0	2	5	2	1	10	0	0	0	0	503
16:00	3	457	14	0	2	5	0	0	2	1	0	0	0	484
17:00	5	474	27	0	9	6	0	2	2	0	0	0	0	525
18:00	7	311	14	0	3	4	0	2	1	1	0	0	0	343
19:00	0	214	13	0	0	2	0	0	1	0	0	0	0	230
20:00	0	151	10	0	2	1	0	0	1	0	0	0	0	165
21:00	0	76	4	0	0	0	0	1	1	1	0	0	0	83
22:00	0	39	1	0	0	0	0	0	0	0	0	0	0	40
23:00	1	37	1	0	0	0	0	1	0	0	0	0	0	40
Day Total	40	5383	396	2	87	83	8	44	78	6	0	1	0	6128
Percent	0.7%	87.8%	6.5%	0.0%	1.4%	1.4%	0.1%	0.7%	1.3%	0.1%	0.0%	0.0%	0.0%	
AM Peak	06:00	07:00	07:00	11:00	07:00	07:00	06:00	06:00	09:00	00:00				07:00
Vol.	3	401	45	1	11	11	2	8	8	1				479
PM Peak	18:00	17:00	15:00	14:00	13:00	17:00	15:00	17:00	12:00	13:00		14:00		17:00
Vol.	7	474	28	1	9	6	2	2	11	1		1		525
Grand Total	40	5383	396	2	87	83	8	44	78	6	0	1	0	6128
Percent	0.7%	87.8%	6.5%	0.0%	1.4%	1.4%	0.1%	0.7%	1.3%	0.1%	0.0%	0.0%	0.0%	

All Traffic Data Services, LLC
www.alltrafficdata.net

Date Start: 15-Sep-20
Site Code: 24
Station ID: 24
CO-83 N.O. HOGDEN RD

Start Time	15-Sep-20 Tue	SB	NB	Total						
12:00 AM		25	17	42						
01:00		11	9	20						
02:00		8	7	15						
03:00		7	26	33						
04:00		24	56	80						
05:00		83	204	287						
06:00		250	354	604						
07:00		376	479	855						
08:00		377	445	822						
09:00		334	338	672						
10:00		355	324	679						
11:00		332	345	677						
12:00 PM		340	375	715						
01:00		348	340	688						
02:00		513	396	909						
03:00		536	503	1039						
04:00		714	484	1198						
05:00		751	525	1276						
06:00		648	343	991						
07:00		406	230	636						
08:00		210	165	375						
09:00		123	83	206						
10:00		84	40	124						
11:00		32	40	72						
Total		6887	6128	13015						
Percent		52.9%	47.1%							
AM Peak	-	08:00	07:00	-	-	-	-	-	-	07:00
Vol.	-	377	479	-	-	-	-	-	-	855
PM Peak	-	17:00	17:00	-	-	-	-	-	-	17:00
Vol.	-	751	525	-	-	-	-	-	-	1276
Grand Total		6887	6128							13015
Percent		52.9%	47.1%							
ADT		ADT 13,015	AADT 13,015							

All Traffic Data Services, LLC
www.alltrafficdata.net

Date Start: 15-Sep-20
Site Code: 25
Station ID: 25
CO-83 N.O. WALKER RD (CO-105)

NB

Start Time	Bikes	Cars & Trailers	2 Axle Long	Buses	2 Axle 6 Tire	3 Axle Single	4 Axle Single	<5 Axl Double	5 Axle Double	>6 Axl Double	<6 Axl Multi	6 Axle Multi	>6 Axl Multi	Total
09/15/20	1	13	1	0	0	0	0	0	1	1	0	0	0	17
01:00	0	6	0	0	0	0	0	0	1	0	0	0	0	7
02:00	0	4	0	0	0	0	0	1	1	0	0	0	0	6
03:00	0	19	1	1	0	0	0	0	1	0	0	0	0	22
04:00	0	53	6	1	0	1	0	1	5	0	0	0	0	67
05:00	1	147	16	0	2	1	0	1	7	0	0	0	0	175
06:00	3	304	34	1	2	1	1	0	2	0	1	0	0	349
07:00	1	344	36	1	4	2	0	0	10	0	1	0	0	399
08:00	0	307	24	1	5	10	0	1	8	0	0	0	0	356
09:00	7	246	25	2	5	4	0	1	11	0	0	0	0	301
10:00	2	250	26	0	6	2	0	3	8	0	0	0	0	297
11:00	4	242	28	0	8	4	0	1	9	1	0	0	0	297
12 PM	3	281	27	0	7	5	0	1	9	0	0	0	0	333
13:00	5	255	16	0	5	5	0	1	3	0	0	0	0	290
14:00	7	273	33	2	4	4	0	1	3	0	0	0	0	327
15:00	8	371	23	0	3	5	0	0	9	1	0	0	0	420
16:00	6	415	24	2	2	4	0	1	2	1	0	0	0	457
17:00	6	404	32	2	4	5	0	4	3	0	0	0	0	460
18:00	5	254	16	3	3	3	0	3	2	1	0	0	0	290
19:00	1	187	11	1	0	1	0	0	1	1	0	0	0	203
20:00	2	142	11	1	2	1	0	0	0	0	0	0	0	159
21:00	0	65	5	0	0	0	0	0	5	2	0	0	0	77
22:00	0	38	1	0	2	0	0	0	0	0	0	0	0	41
23:00	1	34	2	0	0	0	0	0	1	0	0	0	0	38
Day Total	63	4654	398	18	64	58	1	20	102	8	2	0	0	5388
Percent	1.2%	86.4%	7.4%	0.3%	1.2%	1.1%	0.0%	0.4%	1.9%	0.1%	0.0%	0.0%	0.0%	
AM Peak	09:00	07:00	07:00	09:00	11:00	08:00	06:00	10:00	09:00	00:00	06:00			07:00
Vol.	7	344	36	2	8	10	1	3	11	1	1			399
PM Peak	15:00	16:00	14:00	18:00	12:00	12:00		17:00	12:00	21:00				17:00
Vol.	8	415	33	3	7	5		4	9	2				460
Grand Total	63	4654	398	18	64	58	1	20	102	8	2	0	0	5388
Percent	1.2%	86.4%	7.4%	0.3%	1.2%	1.1%	0.0%	0.4%	1.9%	0.1%	0.0%	0.0%	0.0%	

All Traffic Data Services, LLC
www.alltrafficdata.net

Date Start: 15-Sep-20
Site Code: 25
Station ID: 25
CO-83 N.O. WALKER RD (CO-105)

SB

Start Time	Bikes	Cars & Trailers	2 Axle Long	Buses	2 Axle 6 Tire	3 Axle Single	4 Axle Single	<5 Axl Double	5 Axle Double	>6 Axl Double	<6 Axl Multi	6 Axle Multi	>6 Axl Multi	Total
09/15/20	1	17	2	0	0	0	0	0	0	0	0	0	0	20
01:00	0	9	1	0	0	0	0	0	0	0	0	0	0	10
02:00	0	6	0	0	1	0	0	0	0	0	0	0	0	7
03:00	0	8	2	0	0	0	0	0	0	0	0	0	0	10
04:00	0	18	3	0	1	0	0	1	0	0	0	0	0	23
05:00	0	57	11	0	6	2	0	1	0	0	0	0	0	77
06:00	1	178	25	0	7	0	0	0	0	0	0	0	0	211
07:00	1	302	31	0	7	0	0	3	0	0	0	0	0	344
08:00	0	205	33	0	8	1	0	3	1	0	0	0	0	251
09:00	2	209	20	0	9	3	0	3	0	0	0	0	0	246
10:00	6	246	24	1	9	1	0	1	1	0	0	0	0	289
11:00	2	243	29	0	14	1	0	0	0	0	0	0	0	289
12 PM	2	235	18	0	11	1	0	2	0	0	0	0	0	269
13:00	2	277	23	0	5	1	0	0	0	0	0	0	0	308
14:00	2	402	36	0	12	1	0	2	4	0	0	0	0	459
15:00	3	342	29	0	10	0	0	1	0	0	0	0	0	385
16:00	4	573	47	0	11	2	0	3	0	0	0	0	0	640
17:00	6	626	42	0	6	1	0	4	0	0	0	0	0	685
18:00	4	495	41	0	12	1	0	3	0	0	0	0	0	556
19:00	5	320	31	0	4	2	0	3	1	0	0	0	0	366
20:00	2	165	20	0	3	0	0	0	0	0	0	0	0	190
21:00	0	88	5	0	0	0	0	0	0	0	0	0	0	93
22:00	0	63	4	0	1	0	0	1	0	1	0	0	0	70
23:00	0	26	3	0	1	0	0	0	0	0	0	0	0	30
Day Total	43	5110	480	1	138	17	0	31	7	1	0	0	0	5828
Percent	0.7%	87.7%	8.2%	0.0%	2.4%	0.3%	0.0%	0.5%	0.1%	0.0%	0.0%	0.0%	0.0%	
AM Peak	10:00	07:00	08:00	10:00	11:00	09:00		07:00	08:00					07:00
Vol.	6	302	33	1	14	3		3	1					344
PM Peak	17:00	17:00	16:00		14:00	16:00		17:00	14:00	22:00				17:00
Vol.	6	626	47		12	2		4	4	1				685
Grand Total	43	5110	480	1	138	17	0	31	7	1	0	0	0	5828
Percent	0.7%	87.7%	8.2%	0.0%	2.4%	0.3%	0.0%	0.5%	0.1%	0.0%	0.0%	0.0%	0.0%	

All Traffic Data Services, LLC
www.alltrafficdata.net

Date Start: 15-Sep-20
Site Code: 25
Station ID: 25
CO-83 N.O. WALKER RD (CO-105)

Start Time	15-Sep-20 Tue	NB	SB	Total						
12:00 AM		17	20	37						
01:00		7	10	17						
02:00		6	7	13						
03:00		22	10	32						
04:00		67	23	90						
05:00		175	77	252						
06:00		349	211	560						
07:00		399	344	743						
08:00		356	251	607						
09:00		301	246	547						
10:00		297	289	586						
11:00		297	289	586						
12:00 PM		333	269	602						
01:00		290	308	598						
02:00		327	459	786						
03:00		420	385	805						
04:00		457	640	1097						
05:00		460	685	1145						
06:00		290	556	846						
07:00		203	366	569						
08:00		159	190	349						
09:00		77	93	170						
10:00		41	70	111						
11:00		38	30	68						
Total		5388	5828	11216						
Percent		48.0%	52.0%							
AM Peak	-	07:00	07:00	-	-	-	-	-	-	07:00
Vol.	-	399	344	-	-	-	-	-	-	743
PM Peak	-	17:00	17:00	-	-	-	-	-	-	17:00
Vol.	-	460	685	-	-	-	-	-	-	1145
Grand Total		5388	5828							11216
Percent		48.0%	52.0%							
ADT		ADT 11,216	AADT 11,216							

B.2. Intersection Turning Movement Counts



(303) 216-2439
www.alltrafficdata.net

Location: 1 CO-83 & SHOUP RD AM
Date: Tuesday, September 15, 2020
Peak Hour: 07:00 AM - 08:00 AM
Peak 15-Minutes: 07:45 AM - 08:00 AM

Peak Hour - All Vehicles

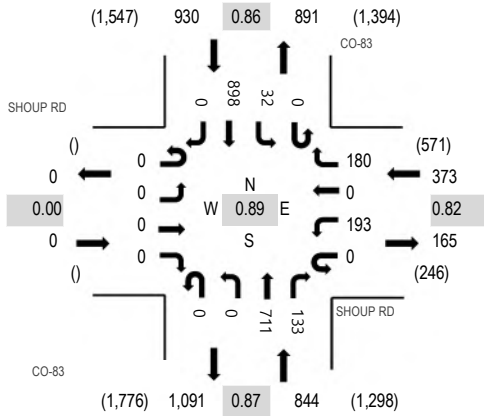

Peak Hour - Pedestrians/Bicycles on Crosswalk

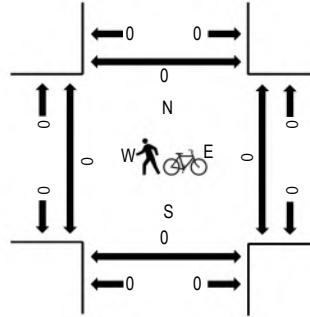

Note: Total study counts contained in parentheses.

Traffic Counts

Interval Start Time	SHOUPE RD Eastbound				SHOUPE RD Westbound				CO-83 Northbound				CO-83 Southbound				Total	Rolling Hour	Pedestrian Crossings			
	U-Turn	Left	Thru	Right	U-Turn	Left	Thru	Right	U-Turn	Left	Thru	Right	U-Turn	Left	Thru	Right			West	East	South	North
6:00 AM	0	0	0	0	0	12	0	13	0	0	62	9	0	2	88	0	186	1,269	0	0	0	0
6:15 AM	0	0	0	0	0	16	0	21	0	0	82	8	0	1	123	0	251	1,561	0	0	0	0
6:30 AM	0	0	0	0	0	28	0	41	0	0	121	16	0	9	190	0	405	1,862	0	0	0	0
6:45 AM	0	0	0	0	0	35	0	32	0	0	131	25	0	11	193	0	427	1,972	0	0	0	0
7:00 AM	0	0	0	0	0	43	0	55	0	0	152	26	0	6	196	0	478	2,147	0	0	0	0
7:15 AM	0	0	0	0	0	34	0	42	0	0	202	40	0	10	224	0	552		0	0	0	0
7:30 AM	0	0	0	0	0	56	0	29	0	0	181	24	0	6	219	0	515		0	0	0	0
7:45 AM	0	0	0	0	0	60	0	54	0	0	176	43	0	10	259	0	602		0	0	0	0
Count Total	0	0	0	0	0	284	0	287	0	0	1,107	191	0	55	1,492	0	3,416		0	0	0	0
Peak Hour	0	0	0	0	0	193	0	180	0	0	711	133	0	32	898	0	2,147		0	0	0	0



(303) 216-2439
www.alltrafficdata.net

Location: 2 CO-83 & FLYING HORSE CLUB RD AM

Date: Tuesday, September 15, 2020

Peak Hour: 07:00 AM - 08:00 AM

Peak 15-Minutes: 07:30 AM - 07:45 AM

Peak Hour - All Vehicles

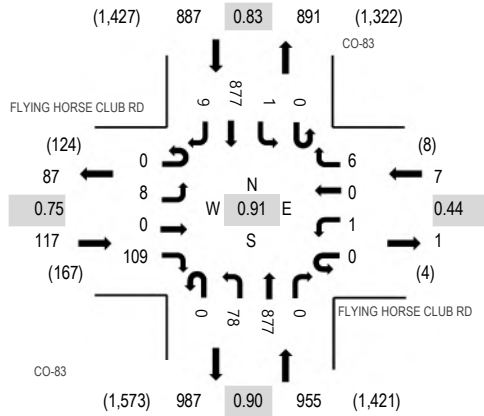

Peak Hour - Pedestrians/Bicycles on Crosswalk

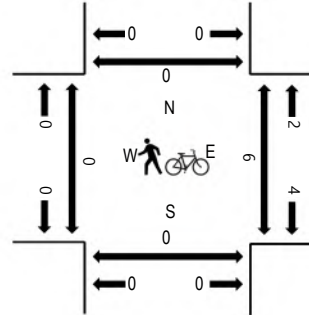

Note: Total study counts contained in parentheses.

Traffic Counts

Interval Start Time	FLYING HORSE CLUB RD Eastbound				FLYING HORSE CLUB RD Westbound				CO-83 Northbound				CO-83 Southbound				Total	Rolling Hour	Pedestrian Crossings				
	U-Turn	Left	Thru	Right	U-Turn	Left	Thru	Right	U-Turn	Left	Thru	Right	U-Turn	Left	Thru	Right			West	East	South	North	
6:00 AM	0	0	0	6	0	0	0	0	0	3	65	0	0	0	0	104	1	179	1,057	0	0	0	0
6:15 AM	0	1	0	5	0	0	0	0	0	2	92	0	0	0	0	110	1	211	1,294	0	0	0	0
6:30 AM	0	0	1	18	0	0	0	0	0	12	114	0	0	0	0	160	0	305	1,603	0	0	0	0
6:45 AM	0	1	0	18	0	1	0	0	0	18	158	2	0	0	0	164	0	362	1,838	0	1	0	0
7:00 AM	0	2	0	27	0	0	0	0	0	11	193	0	0	0	0	181	2	416	1,966	0	3	0	0
7:15 AM	0	4	0	20	0	1	0	3	0	16	249	0	0	0	0	227	0	520		0	0	0	0
7:30 AM	0	1	0	24	0	0	0	2	0	22	223	0	0	0	0	266	2	540		0	0	0	0
7:45 AM	0	1	0	38	0	0	0	1	0	29	212	0	0	1	203	5	490		0	2	0	0	
Count Total	0	10	1	156	0	2	0	6	0	113	1,306	2	0	1	1,415	11	3,023		0	6	0	0	
Peak Hour	0	8	0	109	0	1	0	6	0	78	877	0	0	1	877	9	1,966		0	5	0	0	



(303) 216-2439
www.alltrafficdata.net

Location: 3 CO-83 & CDOT ACCESS AM

Date: Tuesday, September 15, 2020

Peak Hour: 07:00 AM - 08:00 AM

Peak 15-Minutes: 07:30 AM - 07:45 AM

Peak Hour - All Vehicles

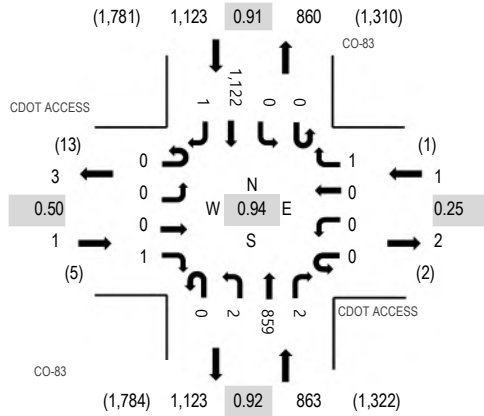

Peak Hour - Pedestrians/Bicycles on Crosswalk

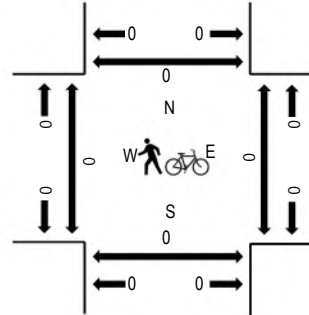

Note: Total study counts contained in parentheses.

Traffic Counts

Interval Start Time	CDOT ACCESS Eastbound				CDOT ACCESS Westbound				CO-83 Northbound			CO-83 Southbound				Total	Rolling Hour	Pedestrian Crossings						
	U-Turn	Left	Thru	Right	U-Turn	Left	Thru	Right	U-Turn	Left	Thru	Right	U-Turn	Left	Thru			Right	West	East	South	North		
6:00 AM	0	0	0	1	0	0	0	0	0	0	2	67	0	0	0	0	110	1	181	1,121	0	0	0	0
6:15 AM	0	0	0	0	0	0	0	0	0	0	1	83	0	0	0	0	133	0	217	1,353	0	0	0	0
6:30 AM	0	0	0	1	0	0	0	0	0	0	1	126	0	0	0	0	194	0	322	1,660	0	0	0	0
6:45 AM	0	0	0	2	0	0	0	0	0	0	5	174	0	0	0	0	220	0	401	1,867	0	0	0	0
7:00 AM	0	0	0	0	0	0	0	1	0	1	181	1	0	0	0	0	229	0	413	1,988	0	0	0	0
7:15 AM	0	0	0	1	0	0	0	0	0	0	1	234	0	0	0	0	287	1	524		0	0	0	0
7:30 AM	0	0	0	0	0	0	0	0	0	0	231	0	0	0	0	0	298	0	529		0	0	0	0
7:45 AM	0	0	0	0	0	0	0	0	0	0	213	1	0	0	0	0	308	0	522		0	0	0	0
Count Total	0	0	0	5	0	0	0	1	0	11	1,309	2	0	0	0	1,779	2	3,109		0	0	0	0	
Peak Hour	0	0	0	1	0	0	0	1	0	2	859	2	0	0	0	1,122	1	1,988		0	0	0	0	



(303) 216-2439
www.alltrafficdata.net

Location: 4 CO-83 & CO-21 NB RAMP AM
Date: Tuesday, September 15, 2020
Peak Hour: 07:00 AM - 08:00 AM
Peak 15-Minutes: 07:45 AM - 08:00 AM

Peak Hour - All Vehicles

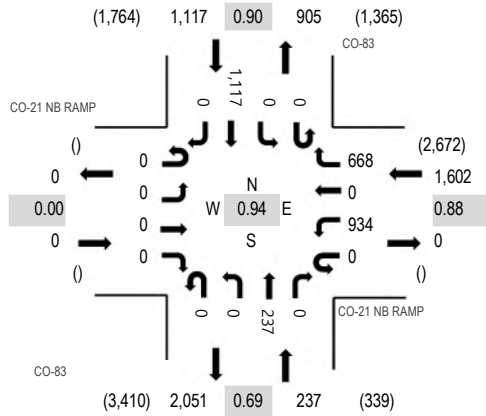

Note: Total study counts contained in parentheses.

Peak Hour - Pedestrians/Bicycles on Crosswalk

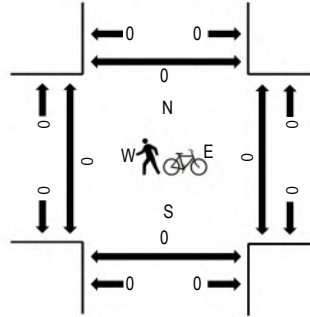

Traffic Counts

Interval Start Time	CO-21 NB RAMP Eastbound				CO-21 NB RAMP Westbound				CO-83 Northbound				CO-83 Southbound				Total	Rolling Hour	Pedestrian Crossings			
	U-Turn	Left	Thru	Right	U-Turn	Left	Thru	Right	U-Turn	Left	Thru	Right	U-Turn	Left	Thru	Right			West	East	South	North
6:00 AM	0	0	0	0	0	133	0	58	0	0	12	0	0	0	109	0	312	1,819	0	0	0	0
6:15 AM	0	0	0	0	0	145	0	74	0	0	10	0	0	0	127	0	356	2,129	0	0	0	0
6:30 AM	0	0	0	0	0	186	0	99	0	0	31	0	0	0	205	0	521	2,552	0	0	0	0
6:45 AM	0	0	0	0	0	248	0	127	0	0	49	0	0	0	206	0	630	2,799	0	0	0	0
7:00 AM	0	0	0	0	0	198	0	155	0	0	37	0	0	0	232	0	622	2,956	0	0	0	0
7:15 AM	0	0	0	0	0	261	0	195	0	0	49	0	0	0	274	0	779		0	0	0	0
7:30 AM	0	0	0	0	0	219	0	173	0	0	65	0	0	0	311	0	768		0	0	0	0
7:45 AM	0	0	0	0	0	256	0	145	0	0	86	0	0	0	300	0	787		0	0	0	0
Count Total	0	0	0	0	0	1,646	0	1,026	0	0	339	0	0	0	1,764	0	4,775		0	0	0	0
Peak Hour	0	0	0	0	0	934	0	668	0	0	237	0	0	0	1,117	0	2,956		0	0	0	0



(303) 216-2439
www.alltrafficdata.net

Location: 5 CO-83 & CO-21 SB RAMP AM

Date: Tuesday, September 15, 2020

Peak Hour: 07:00 AM - 08:00 AM

Peak 15-Minutes: 07:45 AM - 08:00 AM

Peak Hour - All Vehicles

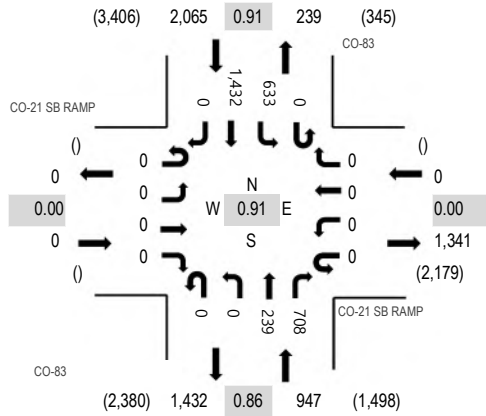

Note: Total study counts contained in parentheses.

Peak Hour - Pedestrians/Bicycles on Crosswalk

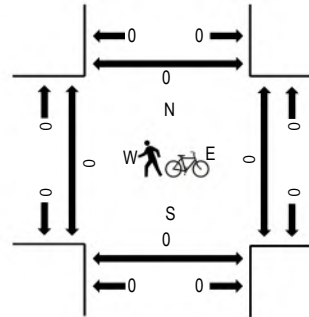

Traffic Counts

Interval Start Time	CO-21 SB RAMP Eastbound				CO-21 SB RAMP Westbound				CO-83 Northbound				CO-83 Southbound				Total	Rolling Hour	Pedestrian Crossings			
	U-Turn	Left	Thru	Right	U-Turn	Left	Thru	Right	U-Turn	Left	Thru	Right	U-Turn	Left	Thru	Right			West	East	South	North
6:00 AM	0	0	0	0	0	0	0	0	0	0	14	77	0	69	172	0	332	1,892	0	0	0	0
6:15 AM	0	0	0	0	0	0	0	0	0	0	10	96	0	76	194	0	376	2,187	0	0	0	0
6:30 AM	0	0	0	0	0	0	0	0	0	0	30	136	0	104	279	0	549	2,576	0	0	0	0
6:45 AM	0	0	0	0	0	0	0	0	0	0	52	136	0	144	303	0	635	2,817	0	0	0	0
7:00 AM	0	0	0	0	0	0	0	0	0	0	35	153	0	139	300	0	627	3,012	0	0	0	0
7:15 AM	0	0	0	0	0	0	0	0	0	0	50	173	0	157	385	0	765		0	0	0	0
7:30 AM	0	0	0	0	0	0	0	0	0	0	64	212	0	173	341	0	790		0	0	0	0
7:45 AM	0	0	0	0	0	0	0	0	0	0	90	170	0	164	406	0	830		0	0	0	0
Count Total	0	0	0	0	0	0	0	0	0	0	345	1,153	0	1,026	2,380	0	4,904		0	0	0	0
Peak Hour	0	0	0	0	0	0	0	0	0	0	239	708	0	633	1,432	0	3,012		0	0	0	0



(303) 216-2439
www.alltrafficdata.net

Location: 6 CO-83 & NORTH GATE BLVD AM
Date: Tuesday, September 15, 2020
Peak Hour: 07:00 AM - 08:00 AM
Peak 15-Minutes: 07:30 AM - 07:45 AM

Peak Hour - All Vehicles

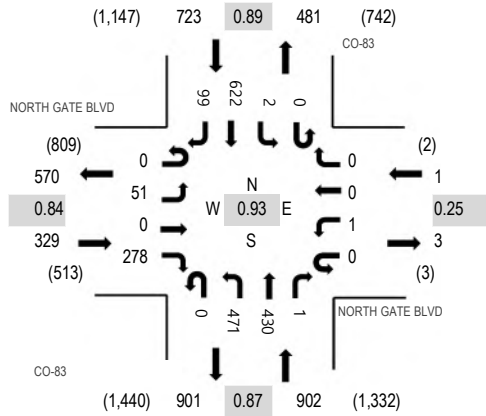

Note: Total study counts contained in parentheses.

Peak Hour - Pedestrians/Bicycles on Crosswalk

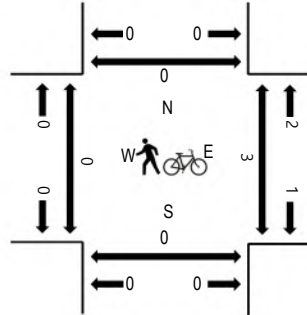

Traffic Counts

Interval Start Time	NORTH GATE BLVD Eastbound				NORTH GATE BLVD Westbound				CO-83 Northbound			CO-83 Southbound				Total	Rolling Hour	Pedestrian Crossings					
	U-Turn	Left	Thru	Right	U-Turn	Left	Thru	Right	U-Turn	Left	Thru	Right	U-Turn	Left	Thru			Right	West	East	South	North	
6:00 AM	0	3	0	30	0	0	0	0	0	28	34	0	0	0	0	79	3	177	1,039	0	0	0	0
6:15 AM	0	3	0	36	0	0	0	0	0	40	55	0	0	0	0	69	10	213	1,280	0	0	0	0
6:30 AM	0	6	0	43	0	0	0	0	0	55	58	0	0	0	0	123	16	301	1,593	0	3	0	0
6:45 AM	0	10	0	53	0	0	1	0	0	68	92	0	0	0	0	106	18	348	1,820	0	0	0	0
7:00 AM	0	5	0	61	0	0	0	0	0	89	99	0	0	1	143	20	418	1,955	0	0	0	0	
7:15 AM	0	19	0	73	0	0	0	0	0	153	106	1	0	1	146	27	526		0	0	0	0	
7:30 AM	0	14	0	84	0	0	0	0	0	123	104	0	0	0	177	26	528		0	1	0	0	
7:45 AM	0	13	0	60	0	1	0	0	0	106	121	0	0	0	156	26	483		0	0	0	0	
Count Total	0	73	0	440	0	1	1	0	0	662	669	1	0	2	999	146	2,994		0	4	0	0	
Peak Hour	0	51	0	278	0	1	0	0	0	471	430	1	0	2	622	99	1,955		0	1	0	0	



(303) 216-2439
www.alltrafficdata.net

Location: 7 CO-83 & PRIVATE ACCESS AM
Date: Tuesday, September 15, 2020
Peak Hour: 07:00 AM - 08:00 AM
Peak 15-Minutes: 07:45 AM - 08:00 AM

Peak Hour - All Vehicles

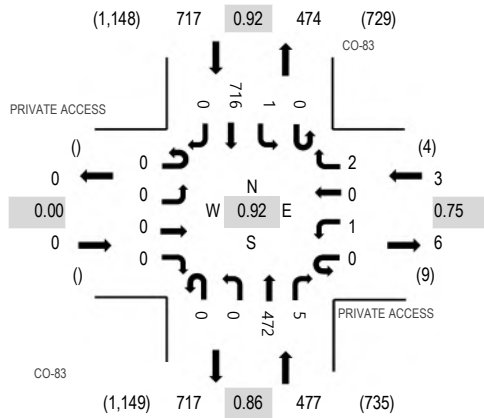

Peak Hour - Pedestrians/Bicycles on Crosswalk

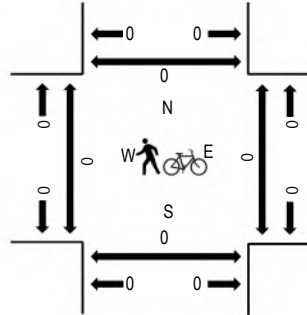

Note: Total study counts contained in parentheses.

Traffic Counts

Interval Start Time	PRIVATE ACCESS Eastbound				PRIVATE ACCESS Westbound				CO-83 Northbound			CO-83 Southbound				Total	Rolling Hour	Pedestrian Crossings					
	U-Turn	Left	Thru	Right	U-Turn	Left	Thru	Right	U-Turn	Left	Thru	Right	U-Turn	Left	Thru			Right	West	East	South	North	
6:00 AM	0	0	0	0	0	0	0	0	0	0	38	0	0	0	0	82	0	120	690	0	0	0	0
6:15 AM	0	0	0	0	0	0	0	0	0	0	57	0	0	0	0	87	0	144	828	0	0	0	0
6:30 AM	0	0	0	0	0	1	0	0	0	0	58	0	0	0	0	131	0	190	989	0	0	0	0
6:45 AM	0	0	0	0	0	0	0	0	0	0	102	3	0	0	0	131	0	236	1,108	0	0	0	0
7:00 AM	0	0	0	0	0	1	0	0	0	0	101	1	0	0	0	155	0	258	1,197	0	0	0	0
7:15 AM	0	0	0	0	0	0	0	0	0	0	123	1	0	0	0	181	0	305		0	0	0	0
7:30 AM	0	0	0	0	0	0	0	1	0	0	113	0	0	0	0	195	0	309		0	0	0	0
7:45 AM	0	0	0	0	0	0	0	1	0	0	135	3	0	1	0	185	0	325		0	0	0	0
Count Total	0	0	0	0	0	2	0	2	0	0	727	8	0	1	0	1,147	0	1,887		0	0	0	0
Peak Hour	0	0	0	0	0	1	0	2	0	0	472	5	0	1	0	716	0	1,197		0	0	0	0



(303) 216-2439
www.alltrafficdata.net

Location: 10 CO-83 & OLD NORTH GATE BLVD

Date: Tuesday, September 15, 2020

Peak Hour: 07:00 AM - 08:00 AM

Peak 15-Minutes: 07:45 AM - 08:00 AM

Peak Hour - All Vehicles

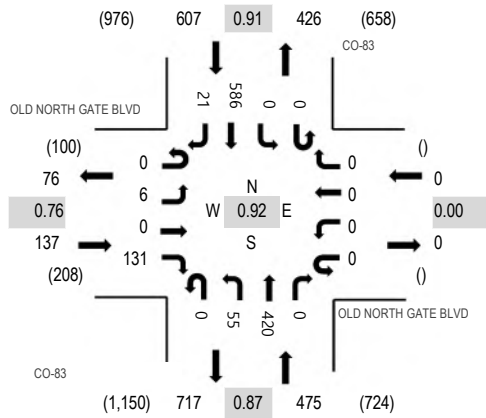

Peak Hour - Pedestrians/Bicycles on Crosswalk

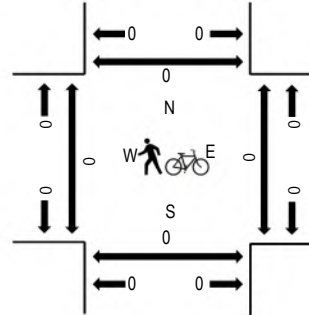

Note: Total study counts contained in parentheses.

Traffic Counts

Interval Start Time	OLD NORTH GATE BLVD Eastbound				OLD NORTH GATE BLVD Westbound				CO-83 Northbound			CO-83 Southbound				Total	Rolling Hour	Pedestrian Crossings					
	U-Turn	Left	Thru	Right	U-Turn	Left	Thru	Right	U-Turn	Left	Thru	Right	U-Turn	Left	Thru			Right	West	East	South	North	
6:00 AM	0	2	0	10	0	0	0	0	0	1	36	0	0	0	0	71	0	120	681	0	0	0	0
6:15 AM	0	0	0	12	0	0	0	0	0	2	53	0	0	0	0	75	0	142	829	0	0	0	0
6:30 AM	0	1	0	19	0	0	0	0	0	4	56	0	0	0	0	113	0	193	996	0	0	0	0
6:45 AM	0	1	0	26	0	0	0	0	0	14	83	0	0	0	0	107	3	234	1,123	0	0	0	0
7:00 AM	0	0	0	24	0	0	0	0	0	11	93	0	0	0	0	130	2	260	1,219	0	0	0	0
7:15 AM	0	5	0	40	0	0	0	0	0	16	102	0	0	0	0	140	6	309		0	0	0	0
7:30 AM	0	1	0	35	0	0	0	0	0	17	100	0	0	0	0	162	5	320		0	0	0	0
7:45 AM	0	0	0	32	0	0	0	0	0	11	125	0	0	0	0	154	8	330		0	0	0	0
Count Total	0	10	0	198	0	0	0	0	0	76	648	0	0	0	0	952	24	1,908		0	0	0	0
Peak Hour	0	6	0	131	0	0	0	0	0	55	420	0	0	0	0	586	21	1,219		0	0	0	0



(303) 216-2439
www.alltrafficdata.net

Location: 11 CO-83 & OLD LASSO POINT RD AM

Date: Tuesday, September 15, 2020

Peak Hour: 07:00 AM - 08:00 AM

Peak 15-Minutes: 07:45 AM - 08:00 AM

Peak Hour - All Vehicles

Peak Hour - Pedestrians/Bicycles on Crosswalk

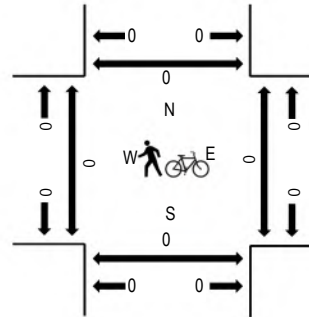
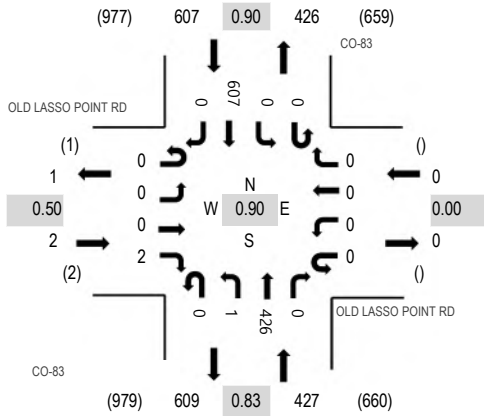

Note: Total study counts contained in parentheses.

Traffic Counts

Interval Start Time	OLD LASSO POINT RD Eastbound				OLD LASSO POINT RD Westbound				CO-83 Northbound			CO-83 Southbound				Total	Rolling Hour	Pedestrian Crossings					
	U-Turn	Left	Thru	Right	U-Turn	Left	Thru	Right	U-Turn	Left	Thru	Right	U-Turn	Left	Thru			Right	West	East	South	North	
6:00 AM	0	0	0	0	0	0	0	0	0	0	38	0	0	0	0	73	0	111	603	0	0	0	0
6:15 AM	0	0	0	0	0	0	0	0	0	0	53	0	0	0	0	72	0	125	717	0	0	0	0
6:30 AM	0	0	0	0	0	0	0	0	0	0	57	0	0	0	0	117	0	174	841	0	0	0	0
6:45 AM	0	0	0	0	0	0	0	0	0	0	85	0	0	0	0	108	0	193	942	0	0	0	0
7:00 AM	0	0	0	0	0	0	0	0	0	0	93	0	0	0	0	132	0	225	1,036	0	0	0	0
7:15 AM	0	0	0	0	0	0	0	0	0	0	100	0	0	0	0	149	0	249		0	0	0	0
7:30 AM	0	0	0	1	0	0	0	0	0	0	106	0	0	0	0	168	0	275		0	0	0	0
7:45 AM	0	0	0	1	0	0	0	0	0	1	127	0	0	0	0	158	0	287		0	0	0	0
Count Total	0	0	0	2	0	0	0	0	0	1	659	0	0	0	0	977	0	1,639		0	0	0	0
Peak Hour	0	0	0	2	0	0	0	0	0	1	426	0	0	0	0	607	0	1,036		0	0	0	0



(303) 216-2439
www.alltrafficdata.net

Location: 12 CO-83 & SHAMROCK RANCH RD AM

Date: Tuesday, September 15, 2020

Peak Hour: 07:00 AM - 08:00 AM

Peak 15-Minutes: 07:45 AM - 08:00 AM

Peak Hour - All Vehicles

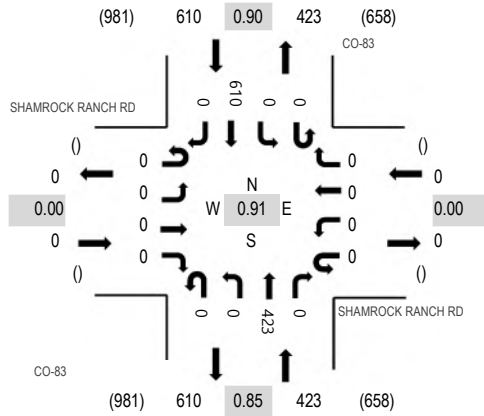

Peak Hour - Pedestrians/Bicycles on Crosswalk

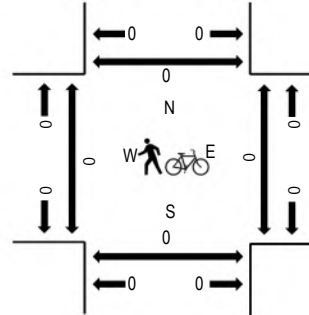

Note: Total study counts contained in parentheses.

Traffic Counts

Interval Start Time	SHAMROCK RANCH RD Eastbound				SHAMROCK RANCH RD Westbound				CO-83 Northbound			CO-83 Southbound				Total	Rolling Hour	Pedestrian Crossings					
	U-Turn	Left	Thru	Right	U-Turn	Left	Thru	Right	U-Turn	Left	Thru	Right	U-Turn	Left	Thru			Right	West	East	South	North	
6:00 AM	0	0	0	0	0	0	0	0	0	0	39	0	0	0	0	74	0	113	606	0	0	0	0
6:15 AM	0	0	0	0	0	0	0	0	0	0	53	0	0	0	0	73	0	126	715	0	0	0	0
6:30 AM	0	0	0	0	0	0	0	0	0	0	55	0	0	0	0	119	0	174	838	0	0	0	0
6:45 AM	0	0	0	0	0	0	0	0	0	0	88	0	0	0	0	105	0	193	943	0	0	0	0
7:00 AM	0	0	0	0	0	0	0	0	0	0	91	0	0	0	0	131	0	222	1,033	0	0	0	0
7:15 AM	0	0	0	0	0	0	0	0	0	0	98	0	0	0	0	151	0	249		0	0	0	0
7:30 AM	0	0	0	0	0	0	0	0	0	0	109	0	0	0	0	170	0	279		0	0	0	0
7:45 AM	0	0	0	0	0	0	0	0	0	0	125	0	0	0	0	158	0	283		0	0	0	0
Count Total	0	0	0	0	0	0	0	0	0	0	658	0	0	0	0	981	0	1,639		0	0	0	0
Peak Hour	0	0	0	0	0	0	0	0	0	0	423	0	0	0	0	610	0	1,033		0	0	0	0



(303) 216-2439
www.alltrafficdata.net

Location: 13 CO-83 & KAESSNER LN AM

Date: Tuesday, September 15, 2020

Peak Hour: 07:00 AM - 08:00 AM

Peak 15-Minutes: 07:45 AM - 08:00 AM

Peak Hour - All Vehicles

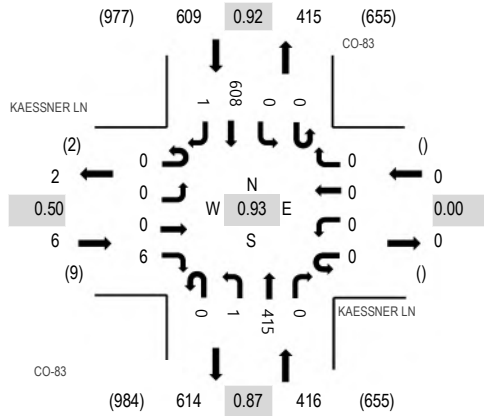

Peak Hour - Pedestrians/Bicycles on Crosswalk

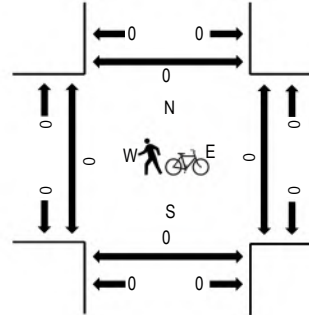

Note: Total study counts contained in parentheses.

Traffic Counts

Interval Start Time	KAESSNER LN Eastbound				KAESSNER LN Westbound				CO-83 Northbound				CO-83 Southbound				Total	Rolling Hour	Pedestrian Crossings				
	U-Turn	Left	Thru	Right	U-Turn	Left	Thru	Right	U-Turn	Left	Thru	Right	U-Turn	Left	Thru	Right			West	East	South	North	
6:00 AM	0	0	0	0	0	0	0	0	0	0	40	0	0	0	0	73	0	113	610	0	0	0	0
6:15 AM	0	0	0	0	0	0	0	0	0	0	52	0	0	0	0	76	0	128	730	0	0	0	0
6:30 AM	0	0	0	2	0	0	0	0	0	0	58	0	0	0	0	114	0	174	850	0	0	0	0
6:45 AM	0	1	0	0	0	0	0	0	0	0	89	0	0	0	0	105	0	195	950	0	0	0	0
7:00 AM	0	0	0	0	0	0	0	0	0	1	91	0	0	0	0	140	1	233	1,031	0	0	0	0
7:15 AM	0	0	0	2	0	0	0	0	0	0	100	0	0	0	0	146	0	248		0	0	0	0
7:30 AM	0	0	0	3	0	0	0	0	0	0	105	0	0	0	0	166	0	274		0	0	0	0
7:45 AM	0	0	0	1	0	0	0	0	0	0	119	0	0	0	0	156	0	276		0	0	0	0
Count Total	0	1	0	8	0	0	0	0	0	1	654	0	0	0	0	976	1	1,641		0	0	0	0
Peak Hour	0	0	0	6	0	0	0	0	0	1	415	0	0	0	0	608	1	1,031		0	0	0	0



(303) 216-2439
www.alltrafficdata.net

Location: 14 CO-83 & STAGECOACH RD AM
Date: Tuesday, September 15, 2020
Peak Hour: 07:00 AM - 08:00 AM
Peak 15-Minutes: 07:45 AM - 08:00 AM

Peak Hour - All Vehicles

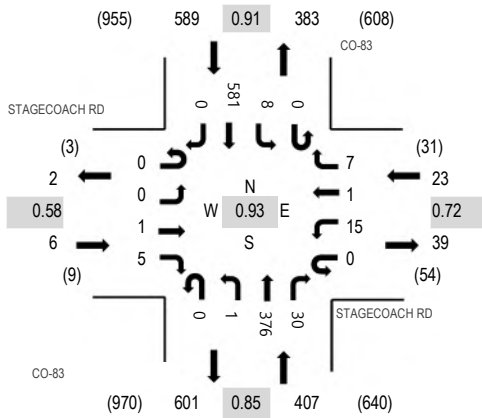

Peak Hour - Pedestrians/Bicycles on Crosswalk

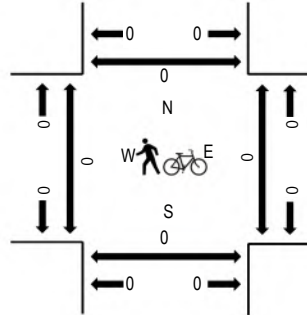

Note: Total study counts contained in parentheses.

Traffic Counts

Interval Start Time	STAGECOACH RD Eastbound				STAGECOACH RD Westbound				CO-83 Northbound				CO-83 Southbound				Total	Rolling Hour	Pedestrian Crossings				
	U-Turn	Left	Thru	Right	U-Turn	Left	Thru	Right	U-Turn	Left	Thru	Right	U-Turn	Left	Thru	Right			West	East	South	North	
6:00 AM	0	0	0	1	0	0	0	0	0	0	38	0	0	0	0	71	0	110	610	0	0	0	0
6:15 AM	0	0	0	0	0	0	0	1	0	0	51	4	0	0	78	0	134	734	0	0	0	0	
6:30 AM	0	0	0	0	0	3	0	0	0	0	50	1	0	0	109	0	163	851	0	0	0	0	
6:45 AM	0	1	1	0	0	1	0	3	0	1	81	7	0	2	106	0	203	953	0	0	0	0	
7:00 AM	0	0	0	3	0	2	0	1	0	0	83	7	0	0	138	0	234	1,025	0	0	0	0	
7:15 AM	0	0	1	0	0	4	1	2	0	0	96	3	0	2	142	0	251		0	0	0	0	
7:30 AM	0	0	0	1	0	3	0	2	0	1	90	7	0	3	158	0	265		0	0	0	0	
7:45 AM	0	0	0	1	0	6	0	2	0	0	107	13	0	3	143	0	275		0	0	0	0	
Count Total	0	1	2	6	0	19	1	11	0	2	596	42	0	10	945	0	1,635		0	0	0	0	
Peak Hour	0	0	1	5	0	15	1	7	0	1	376	30	0	8	581	0	1,025		0	0	0	0	



(303) 216-2439
www.alltrafficdata.net

Location: 15 CO-83 & PRIVATE ACCESS AM
Date: Tuesday, September 15, 2020
Peak Hour: 07:00 AM - 08:00 AM
Peak 15-Minutes: 07:45 AM - 08:00 AM

Peak Hour - All Vehicles

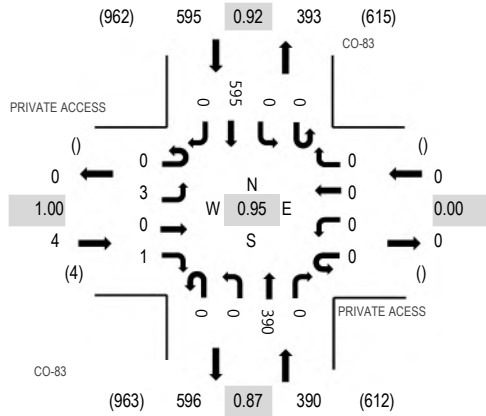

Peak Hour - Pedestrians/Bicycles on Crosswalk

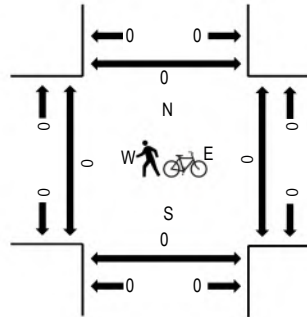

Note: Total study counts contained in parentheses.

Traffic Counts

Interval Start Time	PRIVATE ACCESS Eastbound				PRIVATE ACCESS Westbound				CO-83 Northbound			CO-83 Southbound				Total	Rolling Hour	Pedestrian Crossings					
	U-Turn	Left	Thru	Right	U-Turn	Left	Thru	Right	U-Turn	Left	Thru	Right	U-Turn	Left	Thru			Right	West	East	South	North	
6:00 AM	0	0	0	0	0	0	0	0	0	0	38	0	0	0	0	71	0	109	589	0	0	0	0
6:15 AM	0	0	0	0	0	0	0	0	0	0	47	0	0	0	0	80	0	127	704	0	0	0	0
6:30 AM	0	0	0	0	0	0	0	0	0	0	54	0	0	0	0	108	0	162	827	0	0	0	0
6:45 AM	0	0	0	0	0	0	0	0	0	0	83	0	0	0	0	108	0	191	919	0	0	0	0
7:00 AM	0	1	0	0	0	0	0	0	0	0	83	0	0	0	0	140	0	224	989	0	0	0	0
7:15 AM	0	1	0	0	0	0	0	0	0	0	103	0	0	0	0	146	0	250		0	0	0	0
7:30 AM	0	1	0	0	0	0	0	0	0	0	92	0	0	0	0	161	0	254		0	0	0	0
7:45 AM	0	0	0	1	0	0	0	0	0	0	112	0	0	0	0	148	0	261		0	0	0	0
Count Total	0	3	0	1	0	0	0	0	0	0	612	0	0	0	0	962	0	1,578		0	0	0	0
Peak Hour	0	3	0	1	0	0	0	0	0	0	390	0	0	0	0	595	0	989		0	0	0	0



(303) 216-2439
www.alltrafficdata.net

Location: 16 CO-83 & BENET LANE AM

Date: Tuesday, September 15, 2020

Peak Hour: 07:00 AM - 08:00 AM

Peak 15-Minutes: 07:45 AM - 08:00 AM

Peak Hour - All Vehicles

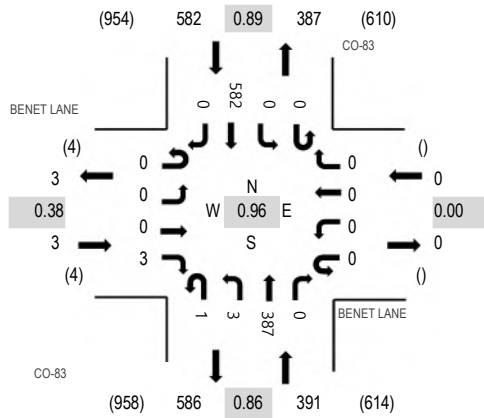

Peak Hour - Pedestrians/Bicycles on Crosswalk

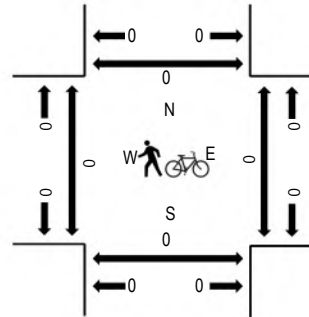

Note: Total study counts contained in parentheses.

Traffic Counts

Interval Start Time	BENET LANE Eastbound				BENET LANE Westbound				CO-83 Northbound			CO-83 Southbound				Total	Rolling Hour	Pedestrian Crossings					
	U-Turn	Left	Thru	Right	U-Turn	Left	Thru	Right	U-Turn	Left	Thru	Right	U-Turn	Left	Thru			Right	West	East	South	North	
6:00 AM	0	0	0	0	0	0	0	0	0	0	38	0	0	0	0	73	0	111	596	0	0	0	0
6:15 AM	0	1	0	0	0	0	0	0	0	0	48	0	0	0	0	77	0	126	704	0	0	0	0
6:30 AM	0	0	0	0	0	0	0	0	0	0	53	0	0	0	0	110	0	163	828	0	0	0	0
6:45 AM	0	0	0	0	0	0	0	0	0	1	83	0	0	0	0	112	0	196	918	0	0	0	0
7:00 AM	0	0	0	2	0	0	0	0	0	1	81	0	0	0	0	135	0	219	976	0	0	0	0
7:15 AM	0	0	0	0	0	0	0	0	0	0	105	0	0	0	0	145	0	250		0	0	0	0
7:30 AM	0	0	0	0	0	0	0	0	1	1	88	0	0	0	0	163	0	253		0	0	0	0
7:45 AM	0	0	0	1	0	0	0	0	0	1	113	0	0	0	0	139	0	254		0	0	0	0
Count Total	0	1	0	3	0	0	0	0	1	4	609	0	0	0	0	954	0	1,572		0	0	0	0
Peak Hour	0	0	0	3	0	0	0	0	1	3	387	0	0	0	0	582	0	976		0	0	0	0



(303) 216-2439
www.alltrafficdata.net

Location: 17 CO-83 & HIGH FOREST RD AM

Date: Tuesday, September 15, 2020

Peak Hour: 07:00 AM - 08:00 AM

Peak 15-Minutes: 07:45 AM - 08:00 AM

Peak Hour - All Vehicles

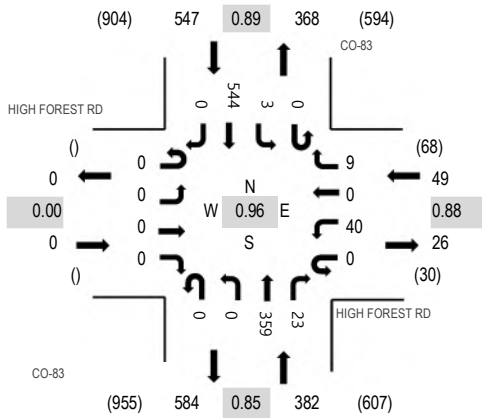

Peak Hour - Pedestrians/Bicycles on Crosswalk

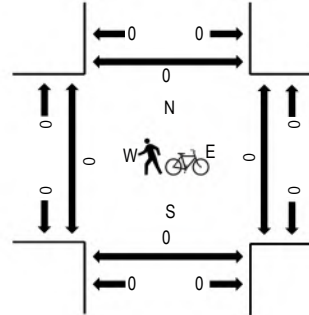

Note: Total study counts contained in parentheses.

Traffic Counts

Interval Start Time	HIGH FOREST RD Eastbound				HIGH FOREST RD Westbound				CO-83 Northbound				CO-83 Southbound				Total	Rolling Hour	Pedestrian Crossings				
	U-Turn	Left	Thru	Right	U-Turn	Left	Thru	Right	U-Turn	Left	Thru	Right	U-Turn	Left	Thru	Right			West	East	South	North	
6:00 AM	0	0	0	0	0	3	0	1	0	0	39	0	0	0	0	72	0	115	601	0	0	0	0
6:15 AM	0	0	0	0	0	4	0	0	0	0	49	0	0	0	0	72	0	125	704	0	0	0	0
6:30 AM	0	0	0	0	0	3	0	1	0	0	53	1	0	0	106	0	0	164	830	0	0	0	0
6:45 AM	0	0	0	0	0	4	0	3	0	0	80	3	0	0	107	0	0	197	920	0	0	0	0
7:00 AM	0	0	0	0	0	7	0	2	0	0	77	3	0	1	128	0	0	218	978	0	0	0	0
7:15 AM	0	0	0	0	0	11	0	2	0	0	100	3	0	0	135	0	0	251		0	0	0	0
7:30 AM	0	0	0	0	0	11	0	3	0	0	77	10	0	1	152	0	0	254		0	0	0	0
7:45 AM	0	0	0	0	0	11	0	2	0	0	105	7	0	1	129	0	0	255		0	0	0	0
Count Total	0	0	0	0	0	54	0	14	0	0	580	27	0	3	901	0	0	1,579		0	0	0	0
Peak Hour	0	0	0	0	0	40	0	9	0	0	359	23	0	3	544	0	0	978		0	0	0	0



(303) 216-2439
www.alltrafficdata.net

Location: 18 CO-83 & ARENA RD AM
Date: Tuesday, September 15, 2020
Peak Hour: 07:00 AM - 08:00 AM
Peak 15-Minutes: 07:15 AM - 07:30 AM

Peak Hour - All Vehicles

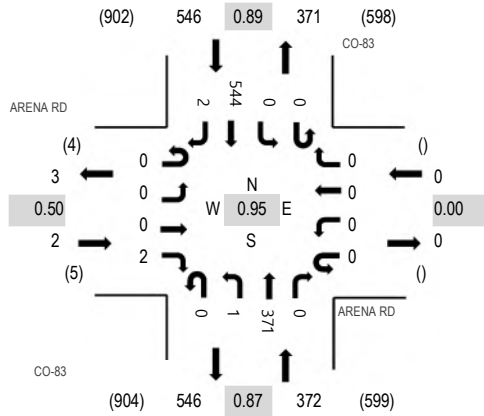

Peak Hour - Pedestrians/Bicycles on Crosswalk

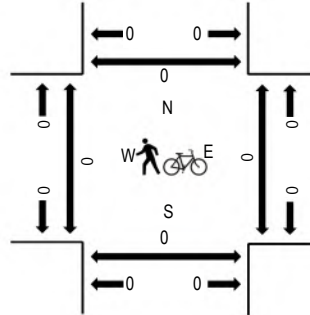

Note: Total study counts contained in parentheses.

Traffic Counts

Interval Start Time	ARENA RD Eastbound				ARENA RD Westbound				CO-83 Northbound				CO-83 Southbound				Total	Rolling Hour	Pedestrian Crossings				
	U-Turn	Left	Thru	Right	U-Turn	Left	Thru	Right	U-Turn	Left	Thru	Right	U-Turn	Left	Thru	Right			West	East	South	North	
6:00 AM	0	0	0	1	0	0	0	0	0	0	40	0	0	0	0	71	0	112	586	0	0	0	0
6:15 AM	0	0	0	0	0	0	0	0	0	0	49	0	0	0	0	73	0	122	684	0	0	0	0
6:30 AM	0	0	0	0	0	0	0	0	0	0	54	0	0	0	0	104	0	158	803	0	0	0	0
6:45 AM	0	1	0	1	0	0	0	0	0	1	83	0	0	0	0	108	0	194	881	0	0	0	0
7:00 AM	0	0	0	0	0	0	0	0	0	1	79	0	0	0	0	130	0	210	920	0	0	0	0
7:15 AM	0	0	0	1	0	0	0	0	0	0	103	0	0	0	0	136	1	241		0	0	0	0
7:30 AM	0	0	0	1	0	0	0	0	0	0	82	0	0	0	0	152	1	236		0	0	0	0
7:45 AM	0	0	0	0	0	0	0	0	0	0	107	0	0	0	0	126	0	233		0	0	0	0
Count Total	0	1	0	4	0	0	0	0	0	2	597	0	0	0	0	900	2	1,506		0	0	0	0
Peak Hour	0	0	0	2	0	0	0	0	0	1	371	0	0	0	0	544	2	920		0	0	0	0



(303) 216-2439
www.alltrafficdata.net

Location: 19 CO-83 & HOGDEN RD AM
Date: Tuesday, September 15, 2020
Peak Hour: 07:00 AM - 08:00 AM
Peak 15-Minutes: 07:30 AM - 07:45 AM

Peak Hour - All Vehicles

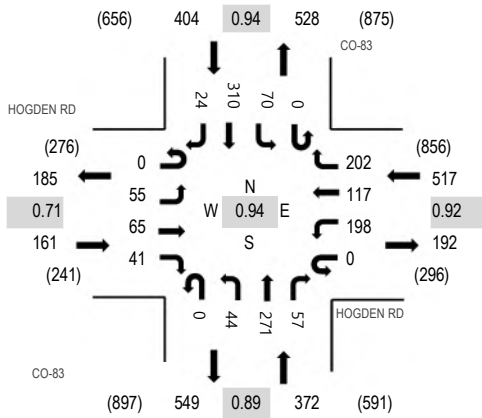

Note: Total study counts contained in parentheses.

Peak Hour - Pedestrians/Bicycles on Crosswalk

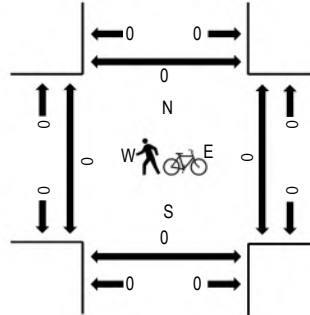

Traffic Counts

Interval Start Time	HOGDEN RD Eastbound				HOGDEN RD Westbound				CO-83 Northbound				CO-83 Southbound				Total	Rolling Hour	Pedestrian Crossings			
	U-Turn	Left	Thru	Right	U-Turn	Left	Thru	Right	U-Turn	Left	Thru	Right	U-Turn	Left	Thru	Right			West	East	South	North
6:00 AM	0	1	8	8	0	17	12	29	0	2	37	3	0	8	40	0	165	890	0	0	0	0
6:15 AM	0	5	6	5	0	31	18	35	0	1	39	3	0	13	45	1	202	1,071	0	0	0	0
6:30 AM	0	3	7	9	0	36	27	44	0	2	49	4	0	18	52	2	253	1,231	0	0	0	0
6:45 AM	0	3	15	10	0	33	18	39	0	6	63	10	0	9	62	2	270	1,364	0	0	0	0
7:00 AM	0	9	6	14	0	46	30	57	0	7	70	8	0	15	80	4	346	1,454	0	0	0	0
7:15 AM	0	26	23	8	0	49	25	43	0	11	72	10	0	20	71	4	362		0	0	0	0
7:30 AM	0	15	21	12	0	53	34	54	0	10	60	19	0	14	86	8	386		0	0	0	0
7:45 AM	0	5	15	7	0	50	28	48	0	16	69	20	0	21	73	8	360		0	0	0	0
Count Total	0	67	101	73	0	315	192	349	0	55	459	77	0	118	509	29	2,344		0	0	0	0
Peak Hour	0	55	65	41	0	198	117	202	0	44	271	57	0	70	310	24	1,454		0	0	0	0



(303) 216-2439
www.alltrafficdata.net

Location: 20 CO-83 & WALDEN WAY AM
Date: Tuesday, September 15, 2020
Peak Hour: 07:00 AM - 08:00 AM
Peak 15-Minutes: 07:45 AM - 08:00 AM

Peak Hour - All Vehicles

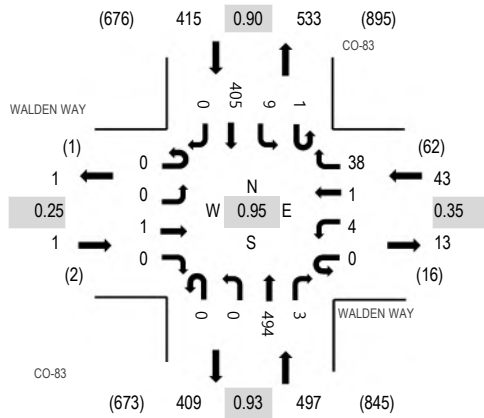

Note: Total study counts contained in parentheses.

Peak Hour - Pedestrians/Bicycles on Crosswalk

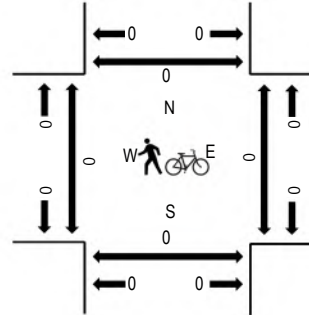

Traffic Counts

Interval Start Time	WALDEN WAY Eastbound				WALDEN WAY Westbound				CO-83 Northbound				CO-83 Southbound				Total	Rolling Hour	Pedestrian Crossings				
	U-Turn	Left	Thru	Right	U-Turn	Left	Thru	Right	U-Turn	Left	Thru	Right	U-Turn	Left	Thru	Right			West	East	South	North	
6:00 AM	0	0	0	0	0	0	0	0	1	0	0	72	0	0	1	56	0	130	629	0	0	0	0
6:15 AM	0	0	0	1	0	0	0	0	0	0	0	77	0	0	1	51	0	130	726	0	0	0	0
6:30 AM	0	0	0	0	0	1	0	6	0	0	0	96	0	0	0	77	0	180	830	0	0	0	0
6:45 AM	0	0	0	0	0	3	0	8	0	0	0	102	1	0	0	75	0	189	893	0	0	0	0
7:00 AM	0	0	0	0	0	1	0	1	0	0	0	132	0	0	1	92	0	227	956	0	0	0	0
7:15 AM	0	0	1	0	0	1	0	5	0	0	0	123	3	0	0	101	0	234		0	0	0	0
7:30 AM	0	0	0	0	0	0	1	3	0	0	0	133	0	1	5	100	0	243		0	0	0	0
7:45 AM	0	0	0	0	0	2	0	29	0	0	0	106	0	0	3	112	0	252		0	0	0	0
Count Total	0	0	1	1	0	8	1	53	0	0	0	841	4	1	11	664	0	1,585		0	0	0	0
Peak Hour	0	0	1	0	0	4	1	38	0	0	0	494	3	1	9	405	0	956		0	0	0	0



(303) 216-2439
www.alltrafficdata.net

Location: 21 CO-83 & WALKER RD AM

Date: Tuesday, September 15, 2020

Peak Hour: 07:00 AM - 08:00 AM

Peak 15-Minutes: 07:30 AM - 07:45 AM

Peak Hour - All Vehicles

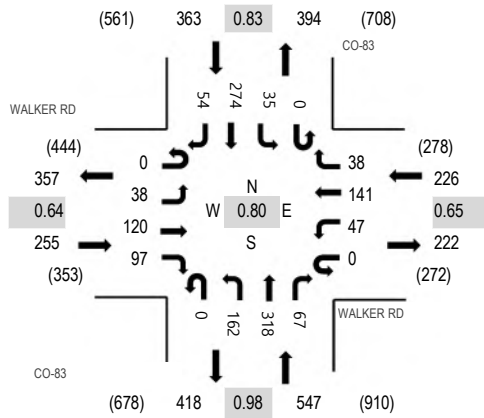

Peak Hour - Pedestrians/Bicycles on Crosswalk

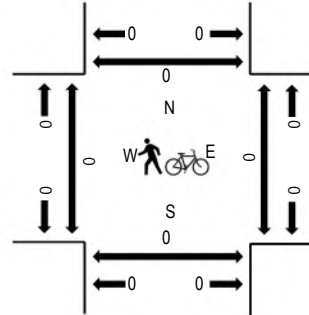

Note: Total study counts contained in parentheses.

Traffic Counts

Interval Start Time	WALKER RD Eastbound				WALKER RD Westbound				CO-83 Northbound				CO-83 Southbound				Total	Rolling Hour	Pedestrian Crossings			
	U-Turn	Left	Thru	Right	U-Turn	Left	Thru	Right	U-Turn	Left	Thru	Right	U-Turn	Left	Thru	Right			West	East	South	North
6:00 AM	0	4	2	12	0	5	3	0	0	5	62	4	0	2	43	1	143	711	0	0	0	0
6:15 AM	0	5	5	15	0	5	3	4	0	11	65	0	0	0	35	4	152	837	0	0	0	0
6:30 AM	0	4	8	14	0	6	3	2	0	15	83	5	0	2	56	5	203	1,042	0	0	0	0
6:45 AM	0	4	9	16	0	8	9	4	0	25	77	11	0	2	45	3	213	1,272	0	0	0	0
7:00 AM	0	14	3	19	0	10	13	6	0	37	87	8	0	1	65	6	269	1,391	0	0	0	0
7:15 AM	0	7	50	21	0	9	28	4	0	30	80	30	0	17	72	9	357		0	0	0	0
7:30 AM	0	10	58	31	0	12	55	20	0	35	77	25	0	14	77	19	433		0	0	0	0
7:45 AM	0	7	9	26	0	16	45	8	0	60	74	4	0	3	60	20	332		0	0	0	0
Count Total	0	55	144	154	0	71	159	48	0	218	605	87	0	41	453	67	2,102		0	0	0	0
Peak Hour	0	38	120	97	0	47	141	38	0	162	318	67	0	35	274	54	1,391		0	0	0	0



(303) 216-2439
www.alltrafficdata.net

Location: 22 CO-83 & PALMER DIVIDE RD AM

Date: Tuesday, September 15, 2020

Peak Hour: 07:00 AM - 08:00 AM

Peak 15-Minutes: 07:15 AM - 07:30 AM

Peak Hour - All Vehicles

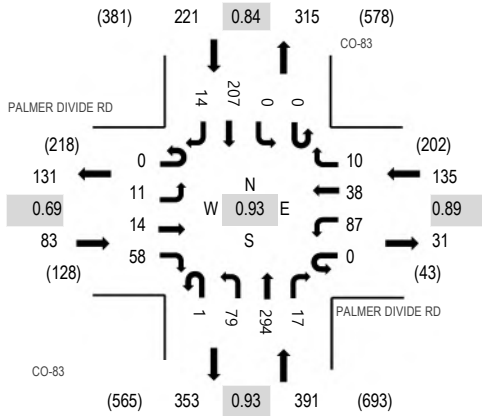

Note: Total study counts contained in parentheses.

Peak Hour - Pedestrians/Bicycles on Crosswalk

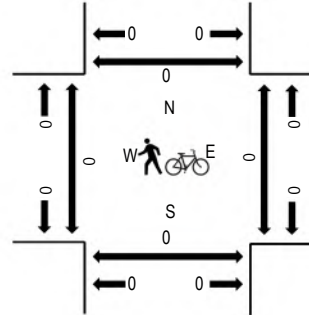

Traffic Counts

Interval Start Time	PALMER DIVIDE RD Eastbound				PALMER DIVIDE RD Westbound				CO-83 Northbound				CO-83 Southbound				Total	Rolling Hour	Pedestrian Crossings			
	U-Turn	Left	Thru	Right	U-Turn	Left	Thru	Right	U-Turn	Left	Thru	Right	U-Turn	Left	Thru	Right			West	East	South	North
6:00 AM	0	4	0	6	0	2	4	3	0	12	54	0	0	0	36	0	121	574	0	0	0	0
6:15 AM	0	1	0	6	0	8	2	0	0	13	51	1	0	0	29	3	114	641	0	0	0	0
6:30 AM	0	5	1	6	0	18	5	1	0	13	67	4	0	0	40	4	164	751	0	0	0	0
6:45 AM	0	5	1	10	0	11	11	2	0	13	70	4	0	1	40	7	175	805	0	0	0	0
7:00 AM	0	2	2	12	0	21	14	3	0	16	81	2	0	0	34	1	188	830	0	0	0	0
7:15 AM	0	3	2	26	0	21	10	2	1	21	68	4	0	0	64	2	224		0	0	0	0
7:30 AM	0	3	6	13	0	26	6	2	0	23	79	3	0	0	52	5	218		0	0	0	0
7:45 AM	0	3	4	7	0	19	8	3	0	19	66	8	0	0	57	6	200		0	0	0	0
Count Total	0	26	16	86	0	126	60	16	1	130	536	26	0	1	352	28	1,404		0	0	0	0
Peak Hour	0	11	14	58	0	87	38	10	1	79	294	17	0	0	207	14	830		0	0	0	0



(303) 216-2439
www.alltrafficdata.net

Location: 1 CO-83 & SHOUP RD PM
Date: Tuesday, September 15, 2020
Peak Hour: 04:45 PM - 05:45 PM
Peak 15-Minutes: 05:15 PM - 05:30 PM

Peak Hour - All Vehicles

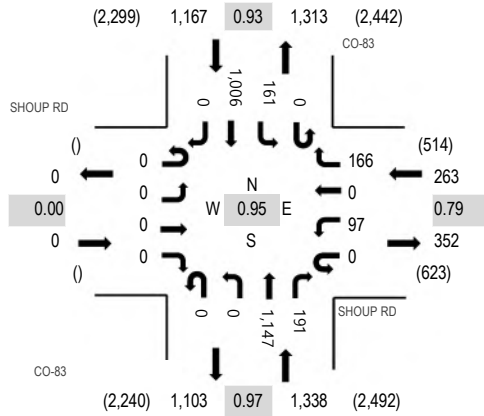

Note: Total study counts contained in parentheses.

Peak Hour - Pedestrians/Bicycles on Crosswalk

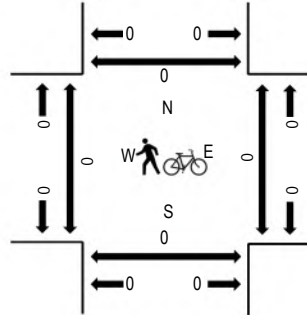

Traffic Counts

Interval Start Time	SHOUP RD Eastbound				SHOUP RD Westbound				CO-83 Northbound				CO-83 Southbound				Total	Rolling Hour	Pedestrian Crossings			
	U-Turn	Left	Thru	Right	U-Turn	Left	Thru	Right	U-Turn	Left	Thru	Right	U-Turn	Left	Thru	Right			West	East	South	North
4:00 PM	0	0	0	0	0	37	0	48	0	0	247	42	0	19	272	0	665	2,574	0	0	0	0
4:15 PM	0	0	0	0	0	27	0	30	0	0	269	42	0	27	249	0	644	2,606	0	0	0	0
4:30 PM	0	0	0	0	0	27	0	32	0	0	239	50	0	33	244	0	625	2,691	0	0	0	0
4:45 PM	0	0	0	0	0	30	0	36	0	0	265	43	0	37	229	0	640	2,768	0	0	0	0
5:00 PM	0	0	0	0	0	15	0	48	0	0	282	62	0	45	245	0	697	2,731	0	0	0	0
5:15 PM	0	0	0	0	0	24	0	46	0	0	301	40	0	47	271	0	729		0	0	0	0
5:30 PM	0	0	0	0	0	28	0	36	0	0	299	46	0	32	261	0	702		0	0	0	0
5:45 PM	0	0	0	0	0	22	0	28	0	0	236	29	0	29	259	0	603		0	0	0	0
Count Total	0	0	0	0	0	210	0	304	0	0	2,138	354	0	269	2,030	0	5,305		0	0	0	0
Peak Hour	0	0	0	0	0	97	0	166	0	0	1,147	191	0	161	1,006	0	2,768		0	0	0	0



(303) 216-2439
www.alltrafficdata.net

Location: 2 CO-83 & FLYING HORSE CLUB RD PM

Date: Tuesday, September 15, 2020

Peak Hour: 04:45 PM - 05:45 PM

Peak 15-Minutes: 05:15 PM - 05:30 PM

Peak Hour - All Vehicles

Peak Hour - Pedestrians/Bicycles on Crosswalk

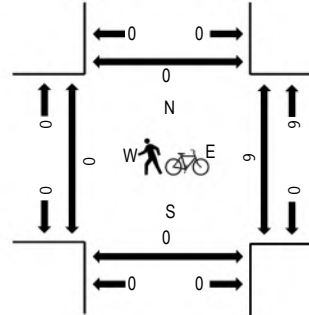
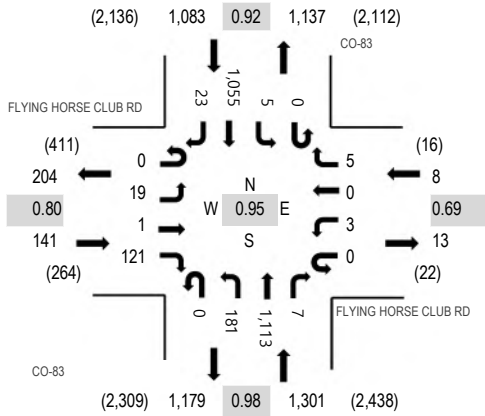

Note: Total study counts contained in parentheses.

Traffic Counts

Interval Start Time	FLYING HORSE CLUB RD Eastbound				FLYING HORSE CLUB RD Westbound				CO-83 Northbound			CO-83 Southbound				Total	Rolling Hour	Pedestrian Crossings				
	U-Turn	Left	Thru	Right	U-Turn	Left	Thru	Right	U-Turn	Left	Thru	Right	U-Turn	Left	Thru			Right	West	East	South	North
4:00 PM	0	4	0	34	0	2	0	1	0	50	255	2	0	1	265	10	624	2,361	0	0	0	0
4:15 PM	0	11	0	26	0	0	0	0	0	24	240	0	0	1	248	3	553	2,370	0	0	0	0
4:30 PM	0	6	0	16	0	4	0	0	0	48	234	4	0	0	255	8	575	2,486	0	0	0	0
4:45 PM	0	4	0	32	0	0	0	1	0	56	261	1	0	0	249	5	609	2,533	0	0	0	0
5:00 PM	0	2	0	34	0	2	0	2	0	47	276	1	0	3	263	3	633	2,493	0	0	0	0
5:15 PM	0	10	1	33	0	1	0	1	0	37	287	4	0	2	282	11	669	2,533	0	0	0	0
5:30 PM	0	3	0	22	0	0	0	1	0	41	289	1	0	0	261	4	622	2,493	0	6	0	0
5:45 PM	0	4	0	22	0	0	0	1	0	60	219	1	0	0	258	4	569	2,486	0	0	0	0
Count Total	0	44	1	219	0	9	0	7	0	363	2,061	14	0	7	2,081	48	4,854	2,533	0	6	0	0
Peak Hour	0	19	1	121	0	3	0	5	0	181	1,113	7	0	5	1,055	23	2,533	2,533	0	6	0	0



(303) 216-2439
www.alltrafficdata.net

Location: 3 CO-83 & CDOT ACCESS PM

Date: Tuesday, September 15, 2020

Peak Hour: 04:45 PM - 05:45 PM

Peak 15-Minutes: 05:15 PM - 05:30 PM

Peak Hour - All Vehicles

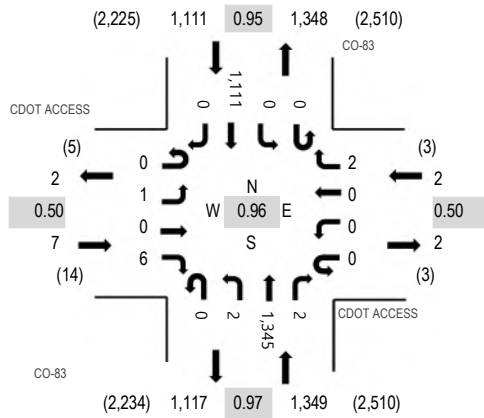

Peak Hour - Pedestrians/Bicycles on Crosswalk

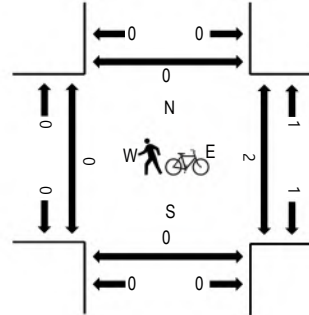

Note: Total study counts contained in parentheses.

Traffic Counts

Interval Start Time	CDOT ACCESS Eastbound				CDOT ACCESS Westbound				CO-83 Northbound				CO-83 Southbound				Total	Rolling Hour	Pedestrian Crossings				
	U-Turn	Left	Thru	Right	U-Turn	Left	Thru	Right	U-Turn	Left	Thru	Right	U-Turn	Left	Thru	Right			West	East	South	North	
4:00 PM	0	0	0	1	0	0	0	0	0	0	310	0	0	0	0	306	2	619	2,323	0	0	0	0
4:15 PM	0	0	0	0	0	0	0	0	0	0	298	1	0	0	0	271	0	570	2,325	0	0	0	0
4:30 PM	0	2	0	3	0	0	0	1	0	1	286	0	0	0	0	275	0	568	2,398	0	0	0	0
4:45 PM	0	0	0	1	0	0	0	0	0	0	317	0	0	0	0	248	0	566	2,469	0	1	0	0
5:00 PM	0	1	0	0	0	0	0	0	0	0	346	1	0	0	0	273	0	621	2,429	0	1	0	0
5:15 PM	0	0	0	3	0	0	0	1	0	1	342	0	0	0	0	296	0	643		0	0	0	0
5:30 PM	0	0	0	2	0	0	0	1	0	1	340	1	0	0	0	294	0	639		0	0	0	0
5:45 PM	0	0	0	1	0	0	0	0	0	0	265	0	0	0	0	260	0	526		0	0	0	0
Count Total	0	3	0	11	0	0	0	3	0	3	2,504	3	0	0	2,223	2	4,752		0	2	0	0	
Peak Hour	0	1	0	6	0	0	0	2	0	2	1,345	2	0	0	1,111	0	2,469		0	2	0	0	



(303) 216-2439
www.alltrafficdata.net

Location: 4 CO-83 & CO-21 NB RAMP PM
Date: Tuesday, September 15, 2020
Peak Hour: 04:45 PM - 05:45 PM
Peak 15-Minutes: 05:15 PM - 05:30 PM

Peak Hour - All Vehicles

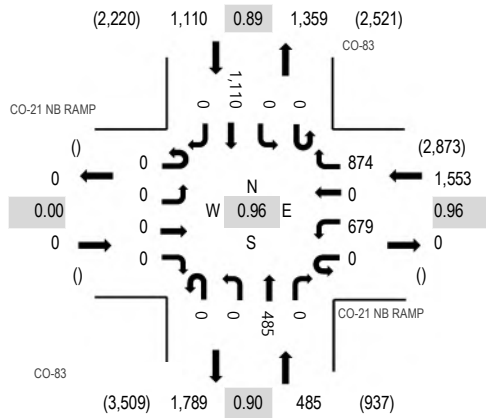

Note: Total study counts contained in parentheses.

Peak Hour - Pedestrians/Bicycles on Crosswalk

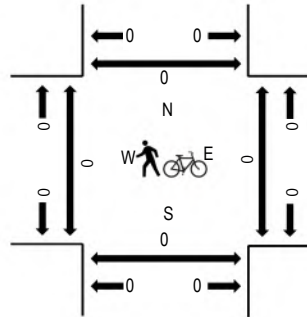

Traffic Counts

Interval Start Time	CO-21 NB RAMP Eastbound				CO-21 NB RAMP Westbound				CO-83 Northbound				CO-83 Southbound				Total	Rolling Hour	Pedestrian Crossings			
	U-Turn	Left	Thru	Right	U-Turn	Left	Thru	Right	U-Turn	Left	Thru	Right	U-Turn	Left	Thru	Right			West	East	South	North
4:00 PM	0	0	0	0	0	143	0	193	0	0	132	0	0	0	296	0	764	2,948	0	0	0	0
4:15 PM	0	0	0	0	0	188	0	170	0	0	116	0	0	0	263	0	737	2,975	0	0	0	0
4:30 PM	0	0	0	0	0	141	0	167	0	0	116	0	0	0	283	0	707	3,059	0	0	0	0
4:45 PM	0	0	0	0	0	173	0	223	0	0	115	0	0	0	229	0	740	3,148	0	0	0	0
5:00 PM	0	0	0	0	0	167	0	212	0	0	136	0	0	0	276	0	791	3,082	0	0	0	0
5:15 PM	0	0	0	0	0	171	0	204	0	0	124	0	0	0	322	0	821		0	0	0	0
5:30 PM	0	0	0	0	0	168	0	235	0	0	110	0	0	0	283	0	796		0	0	0	0
5:45 PM	0	0	0	0	0	138	0	180	0	0	88	0	0	0	268	0	674		0	0	0	0
Count Total	0	0	0	0	0	1,289	0	1,584	0	0	937	0	0	0	2,220	0	6,030		0	0	0	0
Peak Hour	0	0	0	0	0	679	0	874	0	0	485	0	0	0	1,110	0	3,148		0	0	0	0



(303) 216-2439
www.alltrafficdata.net

Location: 5 CO-83 & CO-21 SB RAMP PM
Date: Tuesday, September 15, 2020
Peak Hour: 04:30 PM - 05:30 PM
Peak 15-Minutes: 05:15 PM - 05:30 PM

Peak Hour - All Vehicles

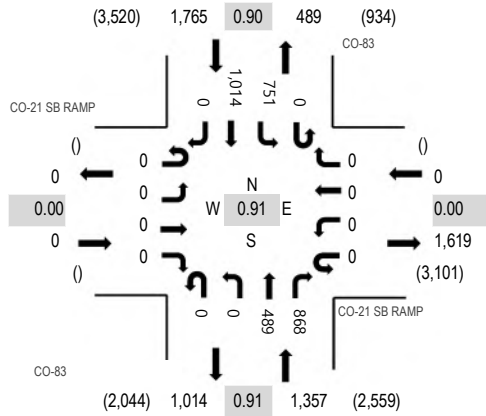

Note: Total study counts contained in parentheses.

Peak Hour - Pedestrians/Bicycles on Crosswalk

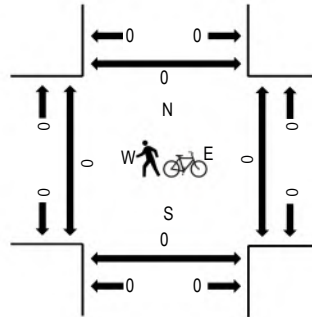

Traffic Counts

Interval Start Time	CO-21 SB RAMP Eastbound				CO-21 SB RAMP Westbound				CO-83 Northbound				CO-83 Southbound				Total	Rolling Hour	Pedestrian Crossings			
	U-Turn	Left	Thru	Right	U-Turn	Left	Thru	Right	U-Turn	Left	Thru	Right	U-Turn	Left	Thru	Right			West	East	South	North
4:00 PM	0	0	0	0	0	0	0	0	0	0	132	201	0	180	247	0	760	2,994	0	0	0	0
4:15 PM	0	0	0	0	0	0	0	0	0	0	114	197	0	181	289	0	781	3,044	0	0	0	0
4:30 PM	0	0	0	0	0	0	0	0	0	0	115	207	0	201	231	0	754	3,122	0	0	0	0
4:45 PM	0	0	0	0	0	0	0	0	0	0	121	178	0	149	251	0	699	3,105	0	0	0	0
5:00 PM	0	0	0	0	0	0	0	0	0	0	132	240	0	181	257	0	810	3,085	0	0	0	0
5:15 PM	0	0	0	0	0	0	0	0	0	0	121	243	0	220	275	0	859		0	0	0	0
5:30 PM	0	0	0	0	0	0	0	0	0	0	113	189	0	179	256	0	737		0	0	0	0
5:45 PM	0	0	0	0	0	0	0	0	0	0	86	170	0	185	238	0	679		0	0	0	0
Count Total	0	0	0	0	0	0	0	0	0	0	934	1,625	0	1,476	2,044	0	6,079		0	0	0	0
Peak Hour	0	0	0	0	0	0	0	0	0	0	489	868	0	751	1,014	0	3,122		0	0	0	0



(303) 216-2439
www.alltrafficdata.net

Location: 6 CO-83 & NORTH GATE BLVD PM
Date: Tuesday, September 15, 2020
Peak Hour: 04:45 PM - 05:45 PM
Peak 15-Minutes: 05:15 PM - 05:30 PM

Peak Hour - All Vehicles

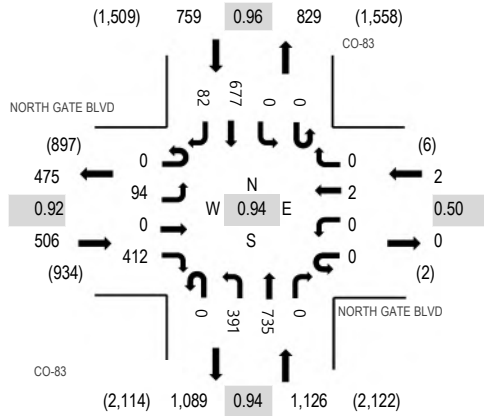

Note: Total study counts contained in parentheses.

Peak Hour - Pedestrians/Bicycles on Crosswalk

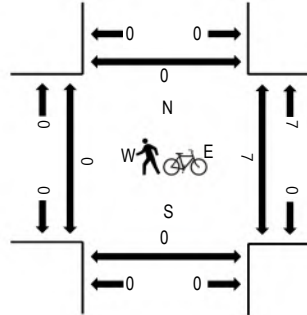

Traffic Counts

Interval Start Time	NORTH GATE BLVD Eastbound				NORTH GATE BLVD Westbound				CO-83 Northbound			CO-83 Southbound				Total	Rolling Hour	Pedestrian Crossings				
	U-Turn	Left	Thru	Right	U-Turn	Left	Thru	Right	U-Turn	Left	Thru	Right	U-Turn	Left	Thru			Right	West	East	South	North
4:00 PM	0	21	0	83	0	2	0	0	0	78	167	0	0	0	166	17	534	2,202	0	0	0	0
4:15 PM	0	31	0	78	0	2	0	0	0	87	163	1	0	0	178	16	556	2,259	0	0	0	0
4:30 PM	0	20	0	100	0	0	0	0	0	104	160	1	0	0	159	11	555	2,337	0	0	0	0
4:45 PM	0	22	0	94	0	0	0	0	0	82	180	0	0	0	157	22	557	2,393	0	0	0	0
5:00 PM	0	21	0	118	0	0	1	0	0	111	156	0	0	0	166	18	591	2,369	0	0	0	0
5:15 PM	0	27	0	107	0	0	1	0	0	101	196	0	0	0	175	27	634		0	2	0	0
5:30 PM	0	24	0	93	0	0	0	0	0	97	203	0	0	0	179	15	611		0	0	0	0
5:45 PM	0	16	0	79	0	0	0	0	0	84	151	0	0	0	178	25	533		0	0	0	0
Count Total	0	182	0	752	0	4	2	0	0	744	1,376	2	0	0	1,358	151	4,571		0	2	0	0
Peak Hour	0	94	0	412	0	0	2	0	0	391	735	0	0	0	677	82	2,393		0	2	0	0



(303) 216-2439
www.alltrafficdata.net

Location: 7 CO-83 & PRIVATE ACCESS PM

Date: Tuesday, September 15, 2020

Peak Hour: 05:00 PM - 06:00 PM

Peak 15-Minutes: 05:15 PM - 05:30 PM

Peak Hour - All Vehicles

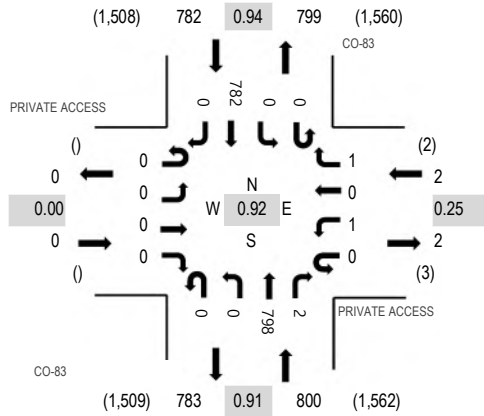

Peak Hour - Pedestrians/Bicycles on Crosswalk

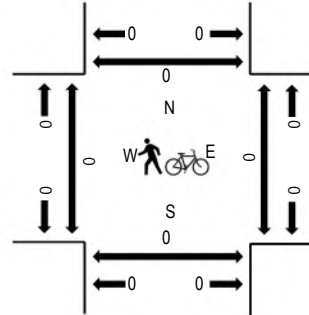

Note: Total study counts contained in parentheses.

Traffic Counts

Interval Start Time	PRIVATE ACCESS Eastbound				PRIVATE ACCESS Westbound				CO-83 Northbound			CO-83 Southbound				Total	Rolling Hour	Pedestrian Crossings					
	U-Turn	Left	Thru	Right	U-Turn	Left	Thru	Right	U-Turn	Left	Thru	Right	U-Turn	Left	Thru			Right	West	East	South	North	
4:00 PM	0	0	0	0	0	0	0	0	0	0	191	0	0	0	0	186	0	377	1,488	0	0	0	0
4:15 PM	0	0	0	0	0	0	0	0	0	0	190	0	0	0	0	197	0	387	1,476	0	0	0	0
4:30 PM	0	0	0	0	0	0	0	0	0	0	180	0	0	0	0	163	0	343	1,520	0	0	0	0
4:45 PM	0	0	0	0	0	0	0	0	0	0	200	1	0	0	0	180	0	381	1,583	0	0	0	0
5:00 PM	0	0	0	0	0	0	0	0	0	0	176	1	0	0	0	188	0	365	1,584	0	0	0	0
5:15 PM	0	0	0	0	0	0	0	0	0	0	226	0	0	0	0	205	0	431		0	0	0	0
5:30 PM	0	0	0	0	0	1	0	1	0	0	222	0	0	0	0	182	0	406		0	0	0	0
5:45 PM	0	0	0	0	0	0	0	0	0	0	174	1	0	0	0	207	0	382		0	0	0	0
Count Total	0	0	0	0	0	1	0	1	0	0	1,559	3	0	0	0	1,508	0	3,072		0	0	0	0
Peak Hour	0	0	0	0	0	1	0	1	0	0	798	2	0	0	0	782	0	1,584		0	0	0	0



(303) 216-2439
www.alltrafficdata.net

Location: 10 CO-83 & OLD NORTH GATE BLVD

Date: Tuesday, September 15, 2020

Peak Hour: 04:45 PM - 05:45 PM

Peak 15-Minutes: 05:15 PM - 05:30 PM

Peak Hour - All Vehicles

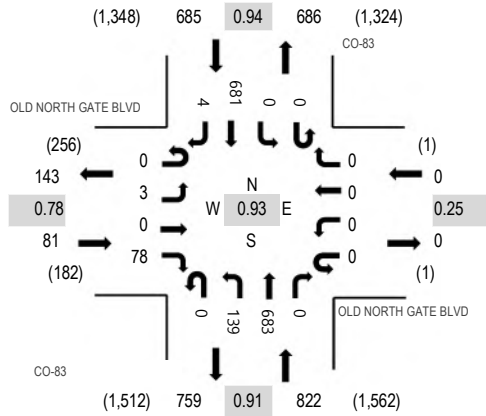

Peak Hour - Pedestrians/Bicycles on Crosswalk

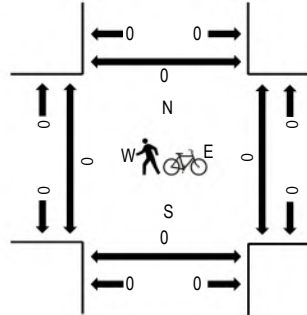

Note: Total study counts contained in parentheses.

Traffic Counts

Interval Start Time	OLD NORTH GATE BLVD Eastbound				OLD NORTH GATE BLVD Westbound				CO-83 Northbound			CO-83 Southbound				Total	Rolling Hour	Pedestrian Crossings					
	U-Turn	Left	Thru	Right	U-Turn	Left	Thru	Right	U-Turn	Left	Thru	Right	U-Turn	Left	Thru			Right	West	East	South	North	
4:00 PM	0	0	0	24	0	0	0	0	0	25	178	0	0	0	0	160	4	391	1,509	0	0	0	0
4:15 PM	0	1	0	16	0	1	0	0	0	24	167	0	0	0	0	183	1	393	1,488	0	0	0	0
4:30 PM	0	2	0	26	0	0	0	0	0	29	144	1	0	0	0	137	2	341	1,523	0	0	0	0
4:45 PM	0	0	0	13	0	0	0	0	0	35	162	0	0	0	0	172	2	384	1,588	0	0	0	0
5:00 PM	0	2	0	27	0	0	0	0	0	31	149	0	0	0	0	161	0	370	1,584	0	0	0	0
5:15 PM	0	0	0	21	0	0	0	0	0	38	187	0	0	0	0	180	2	428		0	0	0	0
5:30 PM	0	1	0	17	0	0	0	0	0	35	185	0	0	0	0	168	0	406		0	0	0	0
5:45 PM	0	0	0	32	0	0	0	0	0	26	146	0	0	0	0	174	2	380		0	0	0	0
Count Total	0	6	0	176	0	1	0	0	0	243	1,318	1	0	0	0	1,335	13	3,093		0	0	0	0
Peak Hour	0	3	0	78	0	0	0	0	0	139	683	0	0	0	0	681	4	1,588		0	0	0	0



(303) 216-2439
www.alltrafficdata.net

Location: 11 CO-83 & OLD LASSO POINT RD PM

Date: Tuesday, September 15, 2020

Peak Hour: 04:45 PM - 05:45 PM

Peak 15-Minutes: 05:15 PM - 05:30 PM

Peak Hour - All Vehicles

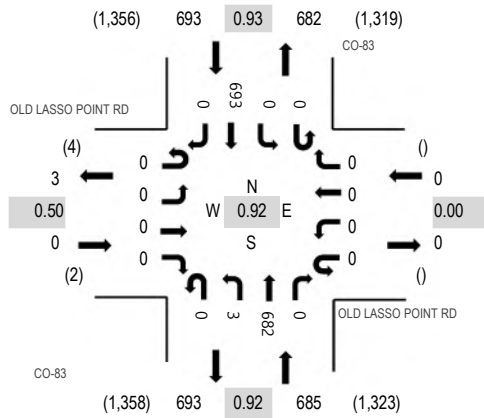

Note: Total study counts contained in parentheses.

Peak Hour - Pedestrians/Bicycles on Crosswalk

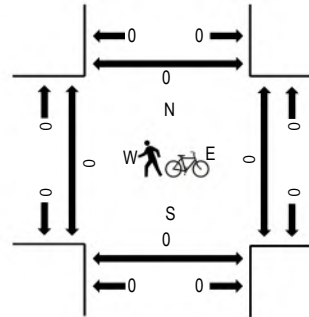

Traffic Counts

Interval Start Time	OLD LASSO POINT RD Eastbound				OLD LASSO POINT RD Westbound				CO-83 Northbound			CO-83 Southbound				Total	Rolling Hour	Pedestrian Crossings					
	U-Turn	Left	Thru	Right	U-Turn	Left	Thru	Right	U-Turn	Left	Thru	Right	U-Turn	Left	Thru			Right	West	East	South	North	
4:00 PM	0	0	0	1	0	0	0	0	0	1	182	0	0	0	0	162	0	346	1,321	0	0	0	0
4:15 PM	0	0	0	0	0	0	0	0	0	0	166	0	0	0	0	186	0	352	1,285	0	0	0	0
4:30 PM	0	0	0	1	0	0	0	0	0	0	149	0	0	0	0	146	0	296	1,306	0	0	0	0
4:45 PM	0	0	0	0	0	0	0	0	0	2	156	0	0	0	0	169	0	327	1,378	0	0	0	0
5:00 PM	0	0	0	0	0	0	0	0	0	1	152	0	0	0	0	157	0	310	1,360	0	0	0	0
5:15 PM	0	0	0	0	0	0	0	0	0	0	187	0	0	0	0	186	0	373		0	0	0	0
5:30 PM	0	0	0	0	0	0	0	0	0	0	187	0	0	0	0	181	0	368		0	0	0	0
5:45 PM	0	0	0	0	0	0	0	0	0	0	140	0	0	0	0	169	0	309		0	0	0	0
Count Total	0	0	0	2	0	0	0	0	0	4	1,319	0	0	0	0	1,356	0	2,681		0	0	0	0
Peak Hour	0	0	0	0	0	0	0	0	0	3	682	0	0	0	0	693	0	1,378		0	0	0	0



(303) 216-2439
www.alltrafficdata.net

Location: 12 CO-83 & SHAMROCK RANCH RD PM

Date: Tuesday, September 15, 2020

Peak Hour: 04:45 PM - 05:45 PM

Peak 15-Minutes: 05:15 PM - 05:30 PM

Peak Hour - All Vehicles

Peak Hour - Pedestrians/Bicycles on Crosswalk

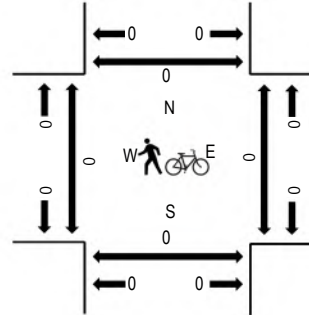
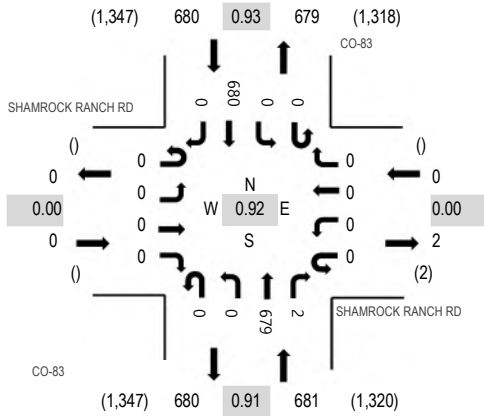

Note: Total study counts contained in parentheses.

Traffic Counts

Interval Start Time	SHAMROCK RANCH RD Eastbound				SHAMROCK RANCH RD Westbound				CO-83 Northbound			CO-83 Southbound				Total	Rolling Hour	Pedestrian Crossings					
	U-Turn	Left	Thru	Right	U-Turn	Left	Thru	Right	U-Turn	Left	Thru	Right	U-Turn	Left	Thru			Right	West	East	South	North	
4:00 PM	0	0	0	0	0	0	0	0	0	0	178	0	0	0	0	169	0	347	1,315	0	0	0	0
4:15 PM	0	0	0	0	0	0	0	0	0	0	171	0	0	0	0	182	0	353	1,276	0	0	0	0
4:30 PM	0	0	0	0	0	0	0	0	0	0	149	0	0	0	0	150	0	299	1,292	0	0	0	0
4:45 PM	0	0	0	0	0	0	0	0	0	0	156	1	0	0	0	159	0	316	1,361	0	0	0	0
5:00 PM	0	0	0	0	0	0	0	0	0	0	151	1	0	0	0	156	0	308	1,352	0	0	0	0
5:15 PM	0	0	0	0	0	0	0	0	0	0	184	0	0	0	0	185	0	369		0	0	0	0
5:30 PM	0	0	0	0	0	0	0	0	0	0	188	0	0	0	0	180	0	368		0	0	0	0
5:45 PM	0	0	0	0	0	0	0	0	0	0	141	0	0	0	0	166	0	307		0	0	0	0
Count Total	0	0	0	0	0	0	0	0	0	0	1,318	2	0	0	0	1,347	0	2,667		0	0	0	0
Peak Hour	0	0	0	0	0	0	0	0	0	0	679	2	0	0	0	680	0	1,361		0	0	0	0



(303) 216-2439
www.alltrafficdata.net

Location: 13 CO-83 & KAESSNER LN PM
Date: Tuesday, September 15, 2020
Peak Hour: 04:45 PM - 05:45 PM
Peak 15-Minutes: 05:15 PM - 05:30 PM

Peak Hour - All Vehicles

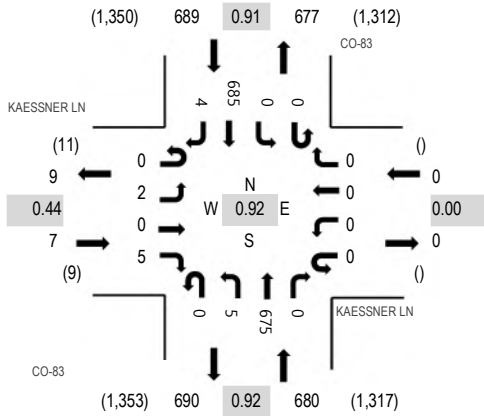

Peak Hour - Pedestrians/Bicycles on Crosswalk

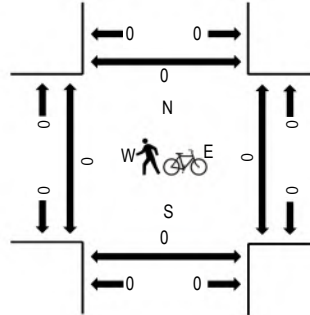

Note: Total study counts contained in parentheses.

Traffic Counts

Interval Start Time	KAESSNER LN Eastbound				KAESSNER LN Westbound				CO-83 Northbound				CO-83 Southbound				Total	Rolling Hour	Pedestrian Crossings				
	U-Turn	Left	Thru	Right	U-Turn	Left	Thru	Right	U-Turn	Left	Thru	Right	U-Turn	Left	Thru	Right			West	East	South	North	
4:00 PM	0	0	0	1	0	0	0	0	0	0	171	0	0	0	0	171	0	343	1,309	0	0	0	0
4:15 PM	0	0	0	0	0	0	0	0	0	0	178	0	0	0	0	179	0	357	1,283	0	0	0	0
4:30 PM	0	0	0	0	0	0	0	0	0	0	142	0	0	0	0	152	0	294	1,301	0	0	0	0
4:45 PM	0	1	0	1	0	0	0	0	0	0	156	0	0	0	0	155	2	315	1,376	0	0	0	0
5:00 PM	0	1	0	3	0	0	0	0	0	1	156	0	0	0	0	156	0	317	1,367	0	0	0	0
5:15 PM	0	0	0	1	0	0	0	0	0	3	181	0	0	0	0	189	1	375		0	0	0	0
5:30 PM	0	0	0	0	0	0	0	0	0	1	182	0	0	0	0	185	1	369		0	0	0	0
5:45 PM	0	0	0	1	0	0	0	0	0	2	144	0	0	0	0	159	0	306		0	0	0	0
Count Total	0	2	0	7	0	0	0	0	0	7	1,310	0	0	0	1,346	4	2,676		0	0	0	0	
Peak Hour	0	2	0	5	0	0	0	0	0	5	675	0	0	0	685	4	1,376		0	0	0	0	



(303) 216-2439
www.alltrafficdata.net

Location: 14 CO-83 & STAGECOACH RD PM
Date: Tuesday, September 15, 2020
Peak Hour: 04:45 PM - 05:45 PM
Peak 15-Minutes: 05:30 PM - 05:45 PM

Peak Hour - All Vehicles

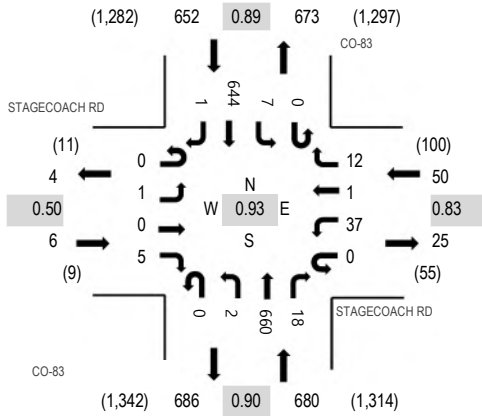

Note: Total study counts contained in parentheses.

Peak Hour - Pedestrians/Bicycles on Crosswalk

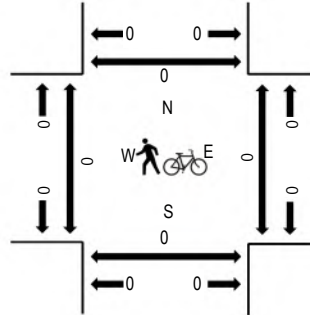

Traffic Counts

Interval Start Time	STAGECOACH RD Eastbound				STAGECOACH RD Westbound				CO-83 Northbound				CO-83 Southbound				Total	Rolling Hour	Pedestrian Crossings			
	U-Turn	Left	Thru	Right	U-Turn	Left	Thru	Right	U-Turn	Left	Thru	Right	U-Turn	Left	Thru	Right			West	East	South	North
4:00 PM	0	0	0	1	0	7	1	5	0	0	168	9	0	0	162	1	354	1,324	0	0	0	0
4:15 PM	0	0	0	0	0	5	0	6	0	1	161	10	0	3	184	0	370	1,295	0	0	0	0
4:30 PM	0	0	0	1	0	9	0	5	0	0	138	4	0	0	128	0	285	1,298	0	0	0	0
4:45 PM	0	1	0	2	0	7	0	5	0	1	144	6	0	4	145	0	315	1,388	0	0	0	0
5:00 PM	0	0	0	1	0	7	0	4	0	0	160	4	0	0	149	0	325	1,381	0	0	0	0
5:15 PM	0	0	0	0	0	10	1	1	0	0	170	6	0	2	182	1	373		0	0	0	0
5:30 PM	0	0	0	2	0	13	0	2	0	1	186	2	0	1	168	0	375		0	0	0	0
5:45 PM	0	0	0	1	0	9	0	3	0	2	138	3	0	1	149	2	308		0	0	0	0
Count Total	0	1	0	8	0	67	2	31	0	5	1,265	44	0	11	1,267	4	2,705		0	0	0	0
Peak Hour	0	1	0	5	0	37	1	12	0	2	660	18	0	7	644	1	1,388		0	0	0	0



(303) 216-2439
www.alltrafficdata.net

Location: 15 CO-83 & PRIVATE ACCESS PM

Date: Tuesday, September 15, 2020

Peak Hour: 04:45 PM - 05:45 PM

Peak 15-Minutes: 05:15 PM - 05:30 PM

Peak Hour - All Vehicles

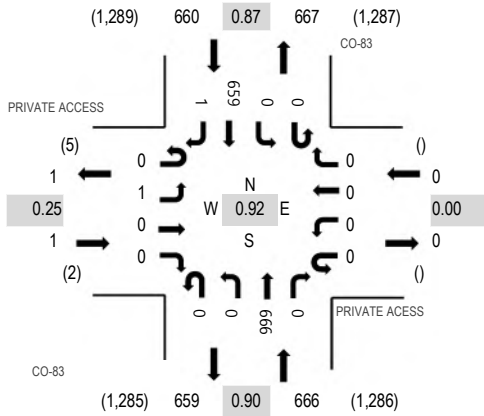

Peak Hour - Pedestrians/Bicycles on Crosswalk

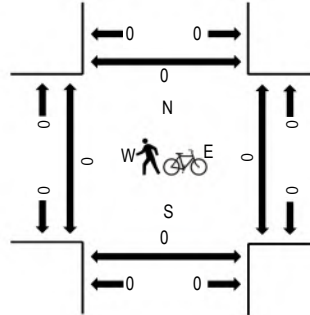

Note: Total study counts contained in parentheses.

Traffic Counts

Interval Start Time	PRIVATE ACCESS Eastbound				PRIVATE ACCESS Westbound				CO-83 Northbound				CO-83 Southbound				Total	Rolling Hour	Pedestrian Crossings				
	U-Turn	Left	Thru	Right	U-Turn	Left	Thru	Right	U-Turn	Left	Thru	Right	U-Turn	Left	Thru	Right			West	East	South	North	
4:00 PM	0	0	0	0	0	0	0	0	0	0	1	162	0	0	0	163	0	326	1,261	0	0	0	0
4:15 PM	0	0	0	0	0	0	0	0	0	0	0	174	0	0	0	186	0	360	1,246	0	0	0	0
4:30 PM	0	0	0	0	0	0	0	0	0	0	0	143	0	0	0	128	1	272	1,248	0	0	0	0
4:45 PM	0	1	0	0	0	0	0	0	0	0	0	149	0	0	0	153	0	303	1,327	0	0	0	0
5:00 PM	0	0	0	0	0	0	0	0	0	0	0	160	0	0	0	151	0	311	1,316	0	0	0	0
5:15 PM	0	0	0	0	0	0	0	0	0	0	0	173	0	0	0	188	1	362		0	0	0	0
5:30 PM	0	0	0	0	0	0	0	0	0	0	0	184	0	0	0	167	0	351		0	0	0	0
5:45 PM	0	1	0	0	0	0	0	0	0	0	0	140	0	0	0	149	2	292		0	0	0	0
Count Total	0	2	0	0	0	0	0	0	0	1	1,285	0	0	0	1,285	4	2,577		0	0	0	0	
Peak Hour	0	1	0	0	0	0	0	0	0	0	666	0	0	0	659	1	1,327		0	0	0	0	



(303) 216-2439
www.alltrafficdata.net

Location: 16 CO-83 & BENET LANE PM

Date: Tuesday, September 15, 2020

Peak Hour: 04:45 PM - 05:45 PM

Peak 15-Minutes: 05:15 PM - 05:30 PM

Peak Hour - All Vehicles

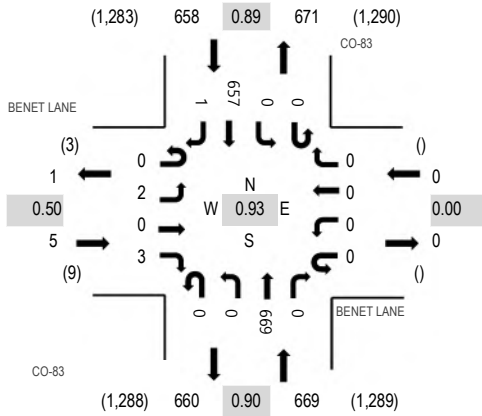

Peak Hour - Pedestrians/Bicycles on Crosswalk

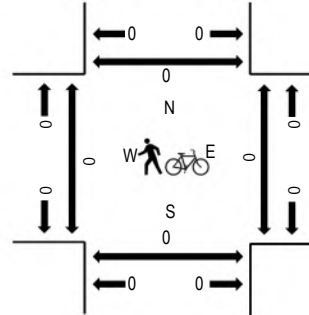

Note: Total study counts contained in parentheses.

Traffic Counts

Interval Start Time	BENET LANE Eastbound				BENET LANE Westbound				CO-83 Northbound				CO-83 Southbound				Total	Rolling Hour	Pedestrian Crossings				
	U-Turn	Left	Thru	Right	U-Turn	Left	Thru	Right	U-Turn	Left	Thru	Right	U-Turn	Left	Thru	Right			West	East	South	North	
4:00 PM	0	1	0	0	0	0	0	0	0	0	2	161	0	0	0	166	0	330	1,265	0	0	0	0
4:15 PM	0	0	0	0	0	0	0	0	0	0	0	170	0	0	0	178	0	348	1,247	0	0	0	0
4:30 PM	0	0	0	2	0	0	0	0	0	0	0	146	0	0	0	133	0	281	1,258	0	0	0	0
4:45 PM	0	0	0	1	0	0	0	0	0	0	0	149	0	0	0	155	1	306	1,332	0	0	0	0
5:00 PM	0	1	0	2	0	0	0	0	0	0	0	160	0	0	0	149	0	312	1,316	0	0	0	0
5:15 PM	0	0	0	0	0	0	0	0	0	0	0	174	0	0	0	185	0	359		0	0	0	0
5:30 PM	0	1	0	0	0	0	0	0	0	0	0	186	0	0	0	168	0	355		0	0	0	0
5:45 PM	0	0	0	1	0	0	0	0	0	0	0	141	0	0	0	148	0	290		0	0	0	0
Count Total	0	3	0	6	0	0	0	0	0	2	1,287	0	0	0	1,282	1	2,581		0	0	0	0	
Peak Hour	0	2	0	3	0	0	0	0	0	0	669	0	0	0	657	1	1,332		0	0	0	0	



(303) 216-2439
www.alltrafficdata.net

Location: 17 CO-83 & HIGH FOREST RD PM

Date: Tuesday, September 15, 2020

Peak Hour: 04:45 PM - 05:45 PM

Peak 15-Minutes: 05:15 PM - 05:30 PM

Peak Hour - All Vehicles

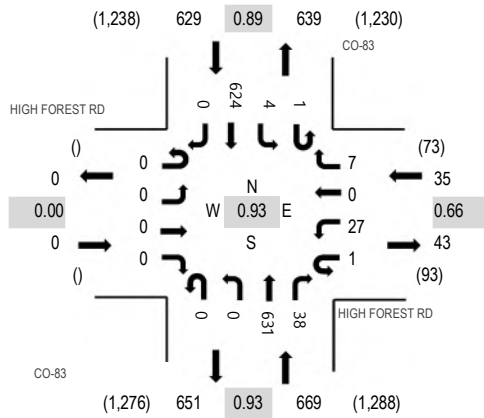

Peak Hour - Pedestrians/Bicycles on Crosswalk

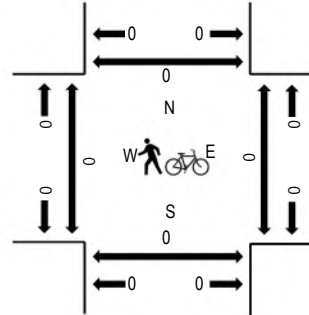

Note: Total study counts contained in parentheses.

Traffic Counts

Interval Start Time	HIGH FOREST RD Eastbound				HIGH FOREST RD Westbound				CO-83 Northbound				CO-83 Southbound				Total	Rolling Hour	Pedestrian Crossings			
	U-Turn	Left	Thru	Right	U-Turn	Left	Thru	Right	U-Turn	Left	Thru	Right	U-Turn	Left	Thru	Right			West	East	South	North
4:00 PM	0	0	0	0	0	10	0	4	0	0	153	10	0	1	155	0	333	1,277	0	0	0	0
4:15 PM	0	0	0	0	0	2	0	3	0	0	160	10	0	2	176	0	353	1,255	0	0	0	0
4:30 PM	0	0	0	0	0	6	0	5	0	0	129	9	0	3	128	0	280	1,261	0	0	0	0
4:45 PM	0	0	0	0	0	5	0	2	0	0	151	6	0	0	147	0	311	1,333	0	0	0	0
5:00 PM	0	0	0	0	0	6	0	0	0	0	151	9	0	1	144	0	311	1,322	0	0	0	0
5:15 PM	0	0	0	0	1	7	0	2	0	0	163	10	1	2	173	0	359		0	0	0	0
5:30 PM	0	0	0	0	0	9	0	3	0	0	166	13	0	1	160	0	352		0	0	0	0
5:45 PM	0	0	0	0	0	5	0	3	0	0	134	14	0	1	143	0	300		0	0	0	0
Count Total	0	0	0	0	1	50	0	22	0	0	1,207	81	1	11	1,226	0	2,599		0	0	0	0
Peak Hour	0	0	0	0	1	27	0	7	0	0	631	38	1	4	624	0	1,333		0	0	0	0



(303) 216-2439
www.alltrafficdata.net

Location: 18 CO-83 & ARENA RD PM

Date: Tuesday, September 15, 2020

Peak Hour: 04:45 PM - 05:45 PM

Peak 15-Minutes: 05:15 PM - 05:30 PM

Peak Hour - All Vehicles

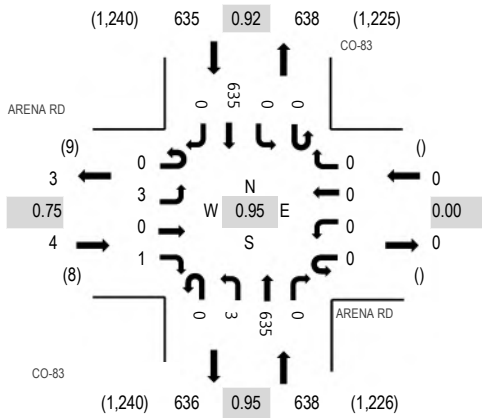

Note: Total study counts contained in parentheses.

Peak Hour - Pedestrians/Bicycles on Crosswalk

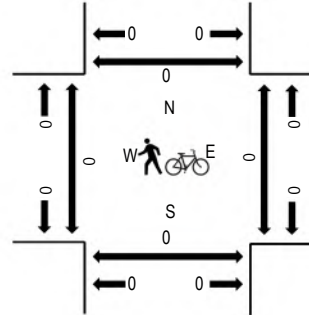

Traffic Counts

Interval Start Time	ARENA RD Eastbound				ARENA RD Westbound				CO-83 Northbound				CO-83 Southbound				Total	Rolling Hour	Pedestrian Crossings				
	U-Turn	Left	Thru	Right	U-Turn	Left	Thru	Right	U-Turn	Left	Thru	Right	U-Turn	Left	Thru	Right			West	East	South	North	
4:00 PM	0	0	0	0	0	0	0	0	0	0	1	157	0	0	0	153	0	311	1,214	0	0	0	0
4:15 PM	0	1	0	1	0	0	0	0	0	0	2	152	0	0	0	171	1	328	1,205	0	0	0	0
4:30 PM	0	0	0	1	0	0	0	0	0	0	0	136	0	0	0	132	1	270	1,213	0	0	0	0
4:45 PM	0	2	0	0	0	0	0	0	0	0	0	153	0	0	0	150	0	305	1,277	0	0	0	0
5:00 PM	0	1	0	0	0	0	0	0	0	0	0	154	0	0	0	147	0	302	1,260	0	0	0	0
5:15 PM	0	0	0	0	0	0	0	0	0	2	2	161	0	0	0	173	0	336		0	0	0	0
5:30 PM	0	0	0	1	0	0	0	0	0	1	1	167	0	0	0	165	0	334		0	0	0	0
5:45 PM	0	1	0	0	0	0	0	0	0	0	0	140	0	0	0	146	1	288		0	0	0	0
Count Total	0	5	0	3	0	0	0	0	0	6	6	1,220	0	0	0	1,237	3	2,474		0	0	0	0
Peak Hour	0	3	0	1	0	0	0	0	0	3	3	635	0	0	0	635	0	1,277		0	0	0	0



(303) 216-2439
www.alltrafficdata.net

Location: 19 CO-83 & HOGDEN RD PM

Date: Tuesday, September 15, 2020

Peak Hour: 04:45 PM - 05:45 PM

Peak 15-Minutes: 05:15 PM - 05:30 PM

Peak Hour - All Vehicles

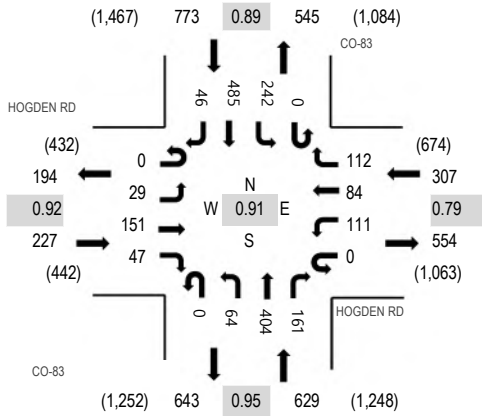

Note: Total study counts contained in parentheses.

Peak Hour - Pedestrians/Bicycles on Crosswalk

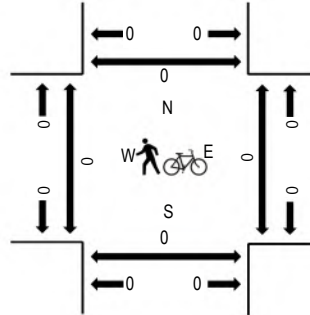

Traffic Counts

Interval Start Time	HOGDEN RD Eastbound				HOGDEN RD Westbound				CO-83 Northbound			CO-83 Southbound				Total	Rolling Hour	Pedestrian Crossings				
	U-Turn	Left	Thru	Right	U-Turn	Left	Thru	Right	U-Turn	Left	Thru	Right	U-Turn	Left	Thru			Right	West	East	South	North
4:00 PM	0	5	35	11	0	36	41	35	0	17	125	28	0	46	116	16	511	1,915	0	0	0	0
4:15 PM	0	9	41	13	0	23	36	32	0	17	90	54	0	55	143	5	518	1,878	0	0	0	0
4:30 PM	0	6	36	10	0	17	33	29	0	10	80	51	0	46	91	17	426	1,889	0	0	0	0
4:45 PM	0	9	45	13	0	26	23	22	0	16	96	36	0	60	110	4	460	1,936	0	0	0	0
5:00 PM	0	6	45	17	0	26	18	38	0	18	99	35	0	54	104	14	474	1,916	0	0	0	0
5:15 PM	0	7	31	9	0	39	26	35	0	13	105	46	0	72	130	16	529		0	0	0	0
5:30 PM	0	7	30	8	0	20	17	17	0	17	104	44	0	56	141	12	473		0	0	0	0
5:45 PM	0	7	36	6	0	33	28	24	0	15	97	35	0	46	110	3	440		0	0	0	0
Count Total	0	56	299	87	0	220	222	232	0	123	796	329	0	435	945	87	3,831		0	0	0	0
Peak Hour	0	29	151	47	0	111	84	112	0	64	404	161	0	242	485	46	1,936		0	0	0	0



(303) 216-2439
www.alltrafficdata.net

Location: 20 CO-83 & WALDEN WAY PM
Date: Tuesday, September 15, 2020
Peak Hour: 04:45 PM - 05:45 PM
Peak 15-Minutes: 05:30 PM - 05:45 PM

Peak Hour - All Vehicles

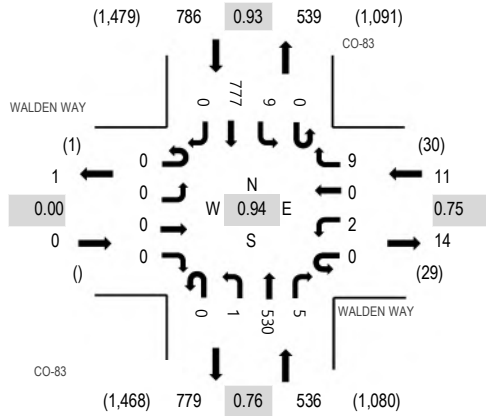

Peak Hour - Pedestrians/Bicycles on Crosswalk

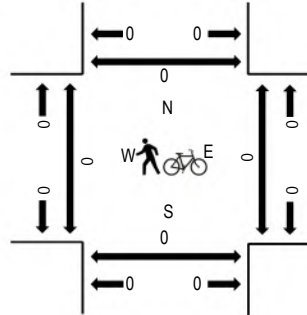

Note: Total study counts contained in parentheses.

Traffic Counts

Interval Start Time	WALDEN WAY Eastbound				WALDEN WAY Westbound				CO-83 Northbound				CO-83 Southbound				Total	Rolling Hour	Pedestrian Crossings			
	U-Turn	Left	Thru	Right	U-Turn	Left	Thru	Right	U-Turn	Left	Thru	Right	U-Turn	Left	Thru	Right			West	East	South	North
4:00 PM	0	0	0	0	0	1	0	5	0	0	177	2	0	0	195	0	380	1,267	0	0	0	0
4:15 PM	0	0	0	0	0	1	0	4	0	0	128	2	0	4	189	0	328	1,227	0	0	0	0
4:30 PM	0	0	0	0	0	3	0	2	0	0	114	2	0	3	134	0	258	1,236	0	0	0	0
4:45 PM	0	0	0	0	0	0	0	2	0	0	115	3	0	2	179	0	301	1,333	0	0	0	0
5:00 PM	0	0	0	0	0	1	0	3	0	0	142	1	0	1	192	0	340	1,322	0	0	0	0
5:15 PM	0	0	0	0	0	1	0	3	0	0	132	0	0	5	196	0	337		0	0	0	0
5:30 PM	0	0	0	0	0	0	0	1	0	1	141	1	0	1	210	0	355		0	0	0	0
5:45 PM	0	0	0	0	0	0	0	3	0	0	119	0	0	2	166	0	290		0	0	0	0
Count Total	0	0	0	0	0	7	0	23	0	1	1,068	11	0	18	1,461	0	2,589		0	0	0	0
Peak Hour	0	0	0	0	0	2	0	9	0	1	530	5	0	9	777	0	1,333		0	0	0	0



(303) 216-2439
www.alltrafficdata.net

Location: 21 CO-83 & WALKER RD PM

Date: Tuesday, September 15, 2020

Peak Hour: 04:45 PM - 05:45 PM

Peak 15-Minutes: 05:00 PM - 05:15 PM

Peak Hour - All Vehicles

Peak Hour - Pedestrians/Bicycles on Crosswalk

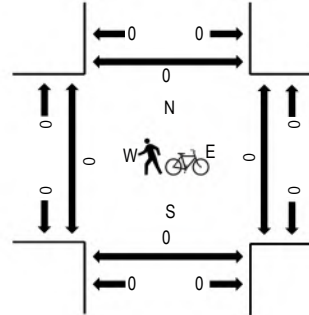
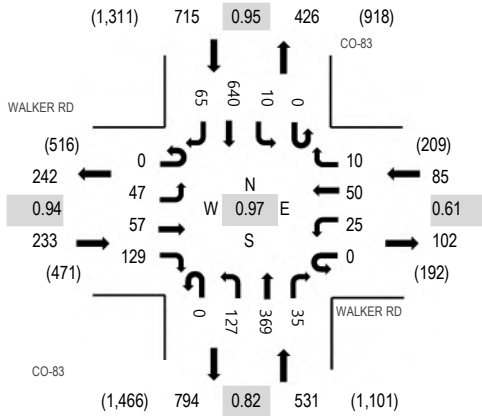

Note: Total study counts contained in parentheses.

Traffic Counts

Interval Start Time	WALKER RD Eastbound				WALKER RD Westbound				CO-83 Northbound				CO-83 Southbound				Total	Rolling Hour	Pedestrian Crossings			
	U-Turn	Left	Thru	Right	U-Turn	Left	Thru	Right	U-Turn	Left	Thru	Right	U-Turn	Left	Thru	Right			West	East	South	North
4:00 PM	0	25	14	25	0	15	26	11	0	31	132	5	0	10	147	20	461	1,553	0	0	0	0
4:15 PM	0	10	14	41	0	9	11	7	0	43	95	7	0	0	136	14	387	1,495	0	0	0	0
4:30 PM	0	15	9	32	0	5	18	4	0	34	85	8	0	2	99	17	328	1,504	0	0	0	0
4:45 PM	0	14	16	37	0	6	12	3	0	33	71	10	0	4	149	22	377	1,564	0	0	0	0
5:00 PM	0	11	17	25	0	12	20	4	0	31	103	8	0	1	157	14	403	1,539	0	0	0	0
5:15 PM	0	11	16	32	0	1	7	0	0	33	100	7	0	5	166	18	396		0	0	0	0
5:30 PM	0	11	8	35	0	6	11	3	0	30	95	10	0	0	168	11	388		0	0	0	0
5:45 PM	0	20	9	24	0	4	12	2	0	35	86	9	0	3	135	13	352		0	0	0	0
Count Total	0	117	103	251	0	58	117	34	0	270	767	64	0	25	1,157	129	3,092		0	0	0	0
Peak Hour	0	47	57	129	0	25	50	10	0	127	369	35	0	10	640	65	1,564		0	0	0	0



(303) 216-2439
www.alltrafficdata.net

Location: 22 CO-83 & PALMER DIVIDE RD PM

Date: Tuesday, September 15, 2020

Peak Hour: 05:00 PM - 06:00 PM

Peak 15-Minutes: 05:00 PM - 05:15 PM

Peak Hour - All Vehicles

Peak Hour - Pedestrians/Bicycles on Crosswalk

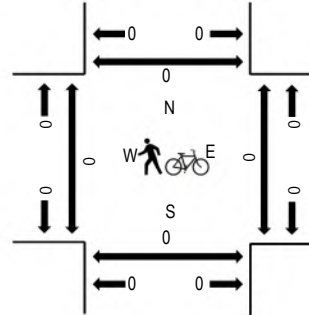
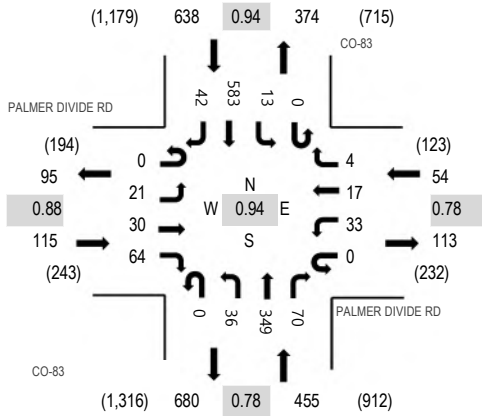

Note: Total study counts contained in parentheses.

Traffic Counts

Interval Start Time	PALMER DIVIDE RD Eastbound				PALMER DIVIDE RD Westbound				CO-83 Northbound			CO-83 Southbound				Total	Rolling Hour	Pedestrian Crossings				
	U-Turn	Left	Thru	Right	U-Turn	Left	Thru	Right	U-Turn	Left	Thru	Right	U-Turn	Left	Thru			Right	West	East	South	North
4:00 PM	0	4	3	18	0	15	3	0	0	19	95	33	0	2	141	4	337	1,195	0	0	0	0
4:15 PM	0	6	7	16	0	12	10	0	0	14	92	26	0	2	111	4	300	1,194	0	0	0	0
4:30 PM	0	10	7	20	0	9	3	0	0	11	73	16	0	2	109	5	265	1,195	0	0	0	0
4:45 PM	0	5	8	24	0	12	5	0	0	11	56	11	0	2	149	10	293	1,250	0	0	0	0
5:00 PM	0	4	4	19	0	10	3	2	0	9	95	17	0	5	151	17	336	1,262	0	0	0	0
5:15 PM	0	3	4	15	0	7	7	1	0	11	82	11	0	2	149	9	301		0	0	0	0
5:30 PM	0	9	7	18	0	7	6	0	0	5	93	16	0	5	148	6	320		0	0	0	0
5:45 PM	0	5	15	12	0	9	1	1	0	11	79	26	0	1	135	10	305		0	0	0	0
Count Total	0	46	55	142	0	81	38	4	0	91	665	156	0	21	1,093	65	2,457		0	0	0	0
Peak Hour	0	21	30	64	0	33	17	4	0	36	349	70	0	13	583	42	1,262		0	0	0	0

This page intentionally left blank.

Appendix C. Crash Data

C.1. Overall Summary by Segments



Colorado Department of Transportation
DiExSys™ Roadway Safety Systems
Detailed Summary of Crashes Report

09/24/2020

Job #: 20200924145135

Location: 83A Begin: 20.37 End: 22.80 From:12/31/2014 To:12/31/2019

Severity	
PDO:	72
INJ:	31 51 :Injured
FAT:	2 2 :Killed
Total:	105

Number of Vehicles	
One Vehicle:	27
Two Vehicles:	70
Three or More:	8
Unknown:	0
Total:	105

Location	
On Road:	85
Off Road Left:	6
Off Road Right:	12
Off Road at Tee:	1
Off in Median:	1
Unknown:	0
Total:	105

Lighting Conditions	
Daylight:	73
Dawn or Dusk:	5
Dark - Lighted:	12
Dark - Unlighted:	15
Unknown:	0
Total:	105

Weather Conditions	
None:	90
Rain:	10
Snow/Sleet/Hail:	2
Fog:	1
Dust:	0
Wind:	0
Unknown:	2
Total:	105

Crash Rates	
PDO:	1.09* * MVMT
INJ:	0.47* ** 100 MVMT
FAT:	3.04**
Total:	1.59*

Crash Type			
Overtuning:	3	Bridge Abutment:	0
Other Non Collision:	2	Column/Pier:	0
Pedestrians:	0	Culvert/Headwall:	1
Broadside:	6	Embankment:	1
Head On:	1	Curb:	2
Rear End:	41	Delineator Post:	0
Sideswipe (Same):	7	Fence:	3
Sideswipe (Opposite):	0	Tree:	0
Approach Turn:	18	Large Boulders or Rocks:	0
Overtaking Turn:	3	Barricade:	0
Parked Motor Vehicle:	0	Wall/Building:	0
Railway Vehicle:	0	Crash Cushion:	0
Bicycle:	0	Mailbox:	0
Motorized Bicycle:	0	Other Fixed Object:	0
Domestic Animal:	0	Total Fixed Objects:	15
Wild Animal:	9	Rocks in Roadway:	0
Light/Utility Pole:	2	Vehicle Cargo/Debris:	0
Traffic Signal Pole:	0	Road Maintenance Equipment:	0
Sign:	1	Involving Other Object:	0
Bridge Rail:	0	Total Other Objects:	0
Guard Rail:	5	Unknown:	0
Cable Rail:	0	Total:	105
Concrete Barrier:	0		

Mainline/Ramps/Frontage Roads		Frontage/Ramp Intersections	
Mainline:	105	M:	0 N: 0 O: 0 P: 0
Crossroad (A):	0		
Ramps		Left Frontage Rd (L):	0
B: 0 F: 0 J: 0		Rt Frontage Rd (R):	0
C: 0 G: 0 K: 0		HOV Lanes (V):	0
D: 0 H: 0 T: 0		Unknown:	0
E: 0 I: 0 Z: 0		Total:	105

Road Description	
At Intersection:	39
At Driveway Access:	1
Intersection Related:	27
Non Intersection:	38
In Alley:	0
Roundabout:	0
Ramp:	0
Parking Lot:	0
Unknown:	0
Total:	105

Road Conditions	
Dry:	88
Wet:	13
Muddy:	0
Snowy:	0
Icy:	1
Slushy:	1
Foreign Material:	0
With Road Treatment:	0
Dry w/Icy Road Treatment:	0
Wet w/Icy Road Treatment:	1
Snowy w/Icy Road Treatment:	0
Icy w/Icy Road Treatment:	1
Slushy w/Icy Road Treatment:	0
Unknown:	0
Total:	105

ADT: 15,128 Length: 2.38



Colorado Department of Transportation
DiExSys™ Roadway Safety Systems
Detailed Summary of Crashes Report

09/24/2020

Job #: 20200924145135

Location: 83A Begin: 20.37 End: 22.80 From:12/31/2014 To:12/31/2019

Vehicle Type	Veh 1	Veh 2	Veh 3
Passenger Car/Van:	44	32	4
Passenger Car/Van w/Trl:	1	0	0
Pickup Truck/Utility Van:	18	8	1
Pickup Truck/Utility Van w/Trl:	1	0	0
SUV:	36	36	3
SUV w/Trl:	0	1	0
Truck 10k lbs or Less:	0	0	0
Trucks > 10k lbs/Bus > 15 People:	3	1	0
School Bus < 15 People:	1	0	0
Non School Bus < 15 People:	0	0	0
Motorhome:	0	0	0
Motorcycle:	0	0	0
Bicycle:	0	0	0
Motorized Bicycle:	0	0	0
Farm Equipment:	0	0	0
Hit and Run - Unknown:	1	0	0
Other:	0	0	0
Unknown:	0	0	0
Total:	105	78	8

Vehicle Movement	Veh 1	Veh 2	Veh 3
Going Straight:	42	36	1
Slowing:	6	4	0
Stopped in Traffic:	1	29	7
Making Right Turn:	6	0	0
Making Left Turn:	24	4	0
Making U-Turn:	4	0	0
Passing:	2	2	0
Backing:	0	0	0
Enter/Leave Parked Position:	0	0	0
Starting in Traffic:	0	0	0
Parked:	0	0	0
Changing Lanes:	7	0	0
Avoiding Object/Veh in Road:	2	2	0
Weaving:	3	0	0
Wrong Way:	1	0	0
Other:	7	1	0
Unknown:	0	0	0
Total:	105	78	8

Contributing Factor	Veh 1	Veh 2	Veh 3
No Apparent Contributing Factor:	34	70	7
Asleep at the Wheel:	2	0	0
Illness:	2	0	0
Distracted by Passenger:	2	0	0
Driver Inexperience:	8	0	0
Driver Fatigue:	2	0	0
Driver Preoccupied:	19	0	0
Driver Unfamiliar with Area:	3	0	0
Driver Emotionally Upset:	0	0	0
Evading Law Enforcement Officer:	0	0	0
Physical Disability:	0	0	0
Unknown:	33	8	1
Total:	105	78	8

Direction	Veh 1	Veh 2	Veh 3
North:	27	34	2
Northeast:	0	1	0
East:	13	9	1
Southeast:	0	0	0
South:	49	26	2
Southwest:	5	2	0
West:	11	6	3
Northwest:	0	0	0
Unknown:	0	0	0
Total:	105	78	8

Condition of Driver	Veh 1	Veh 2	Veh 3
No Impairment Suspected:	97	78	8
Alcohol Involved:	7	0	0
RX, Medication, or Drugs Involved:	1	0	0
Illegal Drugs Involved:	0	0	0
Alcohol and Drugs Involved:	0	0	0
Driver/Pedestrian not Observed:	0	0	0
Unknown:	0	0	0
Total:	105	78	8

ADT: 15,128 Length: 2.38



Colorado Department of Transportation
DiExSys™ Roadway Safety Systems
Detailed Summary of Crashes Report

10/12/2020

Job #: 20201012075106

Location: 83A Begin: 22.75 End: 23.75 From:01/01/2014 To:12/31/2019

Severity	
PDO:	15
INJ:	9 11 :Injured
FAT:	0 0 :Killed
Total:	24

Number of Vehicles	
One Vehicle:	12
Two Vehicles:	11
Three or More:	1
Unknown:	0
Total:	24

Location	
On Road:	13
Off Road Left:	1
Off Road Right:	10
Off Road at Tee:	0
Off in Median:	0
Unknown:	0
Total:	24

Lighting Conditions	
Daylight:	16
Dawn or Dusk:	1
Dark - Lighted:	1
Dark - Unlighted:	6
Unknown:	0
Total:	24

Weather Conditions	
None:	21
Rain:	1
Snow/Sleet/Hail:	0
Fog:	1
Dust:	0
Wind:	1
Unknown:	0
Total:	24

Crash Rates	
PDO:	0.62 * * MVMT
INJ:	0.37 * ** 100 MVMT
FAT:	0.00 **
Total:	0.99 *

Crash Type			
Overtuning:	4	Bridge Abutment:	0
Other Non Collision:	0	Column/Pier:	0
Pedestrians:	0	Culvert/Headwall:	0
Broadside:	1	Embankment:	0
Head On:	0	Curb:	0
Rear End:	5	Delineator Post:	0
Sideswipe (Same):	3	Fence:	3
Sideswipe (Opposite):	0	Tree:	2
Approach Turn:	1	Large Boulders or Rocks:	1
Overtaking Turn:	2	Barricade:	0
Parked Motor Vehicle:	0	Wall/Building:	0
Railway Vehicle:	0	Crash Cushion:	0
Bicycle:	0	Mailbox:	0
Motorized Bicycle:	0	Other Fixed Object:	0
Domestic Animal:	0	Total Fixed Objects:	7
Wild Animal:	1	Rocks in Roadway:	0
Light/Utility Pole:	1	Vehicle Cargo/Debris:	0
Traffic Signal Pole:	0	Road Maintenance Equipment:	0
Sign:	0	Involving Other Object:	0
Bridge Rail:	0	Total Other Objects:	0
Guard Rail:	0	Unknown:	0
Cable Rail:	0	Total:	24
Concrete Barrier:	0		

Mainline/Ramps/Frontage Roads		Frontage/Ramp Intersections			
Mainline:	24	M:	0	N:	0
Crossroad (A):	0	O:	0	P:	0
Ramps		Left Frontage Rd (L):	0		
B: 0 F: 0 J: 0		Rt Frontage Rd (R):	0		
C: 0 G: 0 K: 0		HOV Lanes (V):	0		
D: 0 H: 0 T: 0		Unknown:	0	Total:	24
E: 0 I: 0 Z: 0					

Road Description	
At Intersection:	4
At Driveway Access:	4
Intersection Related:	4
Non Intersection:	12
In Alley:	0
Roundabout:	0
Ramp:	0
Parking Lot:	0
Unknown:	0
Total:	24

Road Conditions	
Dry:	20
Wet:	2
Muddy:	0
Snowy:	0
Icy:	0
Slushy:	0
Foreign Material:	0
With Road Treatment:	0
Dry w/Icy Road Treatment:	2
Wet w/Icy Road Treatment:	0
Snowy w/Icy Road Treatment:	0
Icy w/Icy Road Treatment:	0
Slushy w/Icy Road Treatment:	0
Unknown:	0
Total:	24

ADT: 11,213 Length: 0.98



Colorado Department of Transportation
DiExSys™ Roadway Safety Systems
Detailed Summary of Crashes Report

10/12/2020

Job #: 20201012075106

Location: 83A Begin: 22.75 End: 23.75 From:01/01/2014 To:12/31/2019

Vehicle Type	Veh 1	Veh 2	Veh 3
Passenger Car/Van:	12	3	1
Passenger Car/Van w/Trl:	0	0	0
Pickup Truck/Utility Van:	3	3	0
Pickup Truck/Utility Van w/Trl:	1	0	0
SUV:	8	5	0
SUV w/Trl:	0	0	0
Truck 10k lbs or Less:	0	0	0
Trucks > 10k lbs/Bus > 15 People:	0	1	0
School Bus < 15 People:	0	0	0
Non School Bus < 15 People:	0	0	0
Motorhome:	0	0	0
Motorcycle:	0	0	0
Bicycle:	0	0	0
Motorized Bicycle:	0	0	0
Farm Equipment:	0	0	0
Hit and Run - Unknown:	0	0	0
Other:	0	0	0
Unknown:	0	0	0
Total:	24	12	1

Vehicle Movement	Veh 1	Veh 2	Veh 3
Going Straight:	10	5	0
Slowing:	0	1	0
Stopped in Traffic:	0	4	1
Making Right Turn:	2	0	0
Making Left Turn:	1	2	0
Making U-Turn:	0	0	0
Passing:	1	0	0
Backing:	0	0	0
Enter/Leave Parked Position:	0	0	0
Starting in Traffic:	0	0	0
Parked:	0	0	0
Changing Lanes:	3	0	0
Avoiding Object/Veh in Road:	0	0	0
Weaving:	2	0	0
Wrong Way:	0	0	0
Other:	5	0	0
Unknown:	0	0	0
Total:	24	12	1

Contributing Factor	Veh 1	Veh 2	Veh 3
No Apparent Contributing Factor:	4	11	1
Asleep at the Wheel:	2	0	0
Illness:	0	0	0
Distracted by Passenger:	0	0	0
Driver Inexperience:	3	0	0
Driver Fatigue:	2	0	0
Driver Preoccupied:	5	0	0
Driver Unfamiliar with Area:	4	0	0
Driver Emotionally Upset:	0	0	0
Evading Law Enforcement Officer:	0	0	0
Physical Disability:	0	0	0
Unknown:	4	1	0
Total:	24	12	1

Direction	Veh 1	Veh 2	Veh 3
North:	10	4	1
Northeast:	0	0	0
East:	3	2	0
Southeast:	0	0	0
South:	10	5	0
Southwest:	0	0	0
West:	1	1	0
Northwest:	0	0	0
Unknown:	0	0	0
Total:	24	12	1

Condition of Driver	Veh 1	Veh 2	Veh 3
No Impairment Suspected:	23	12	1
Alcohol Involved:	0	0	0
RX, Medication, or Drugs Involved:	1	0	0
Illegal Drugs Involved:	0	0	0
Alcohol and Drugs Involved:	0	0	0
Driver/Pedestrian not Observed:	0	0	0
Unknown:	0	0	0
Total:	24	12	1

ADT: 11,213 Length: 0.98



Colorado Department of Transportation
DiExSys™ Roadway Safety Systems
Detailed Summary of Crashes Report

10/12/2020

Job #: 20201012153130

Location: 83A Begin: 23.75 End: 24.75 From:01/01/2014 To:12/31/2019

Severity	
PDO:	13
INJ:	13 24 :Injured
FAT:	0 0 :Killed
Total:	26

Number of Vehicles	
One Vehicle:	10
Two Vehicles:	12
Three or More:	4
Unknown:	0
Total:	26

Location	
On Road:	20
Off Road Left:	2
Off Road Right:	4
Off Road at Tee:	0
Off in Median:	0
Unknown:	0
Total:	26

Lighting Conditions	
Daylight:	17
Dawn or Dusk:	3
Dark - Lighted:	0
Dark - Unlighted:	6
Unknown:	0
Total:	26

Weather Conditions	
None:	22
Rain:	3
Snow/Sleet/Hail:	1
Fog:	0
Dust:	0
Wind:	0
Unknown:	0
Total:	26

Crash Rates	
PDO:	0.57 * * MVMT
INJ:	0.57 * ** 100 MVMT
FAT:	0.00 **
Total:	1.15 *

Crash Type			
Overtuning:	5	Bridge Abutment:	0
Other Non Collision:	0	Column/Pier:	0
Pedestrians:	0	Culvert/Headwall:	0
Broadside:	0	Embankment:	0
Head On:	3	Curb:	0
Rear End:	6	Delineator Post:	1
Sideswipe (Same):	1	Fence:	0
Sideswipe (Opposite):	2	Tree:	1
Approach Turn:	2	Large Boulders or Rocks:	0
Overtaking Turn:	0	Barricade:	0
Parked Motor Vehicle:	0	Wall/Building:	0
Railway Vehicle:	0	Crash Cushion:	0
Bicycle:	0	Mailbox:	0
Motorized Bicycle:	0	Other Fixed Object:	0
Domestic Animal:	0	Total Fixed Objects:	4
Wild Animal:	2	Rocks in Roadway:	0
Light/Utility Pole:	0	Vehicle Cargo/Debris:	1
Traffic Signal Pole:	0	Road Maintenance Equipment:	0
Sign:	2	Involving Other Object:	0
Bridge Rail:	0	Total Other Objects:	1
Guard Rail:	0	Unknown:	0
Cable Rail:	0	Total:	26
Concrete Barrier:	0		

Mainline/Ramps/Frontage Roads		Frontage/Ramp Intersections			
Mainline:	26	M:	0	N:	0
Crossroad (A):	0	O:	0	P:	0
Ramps		Left Frontage Rd (L):	0		
B: 0 F: 0 J: 0		Rt Frontage Rd (R):	0		
C: 0 G: 0 K: 0		HOV Lanes (V):	0		
D: 0 H: 0 T: 0		Unknown:	0	Total:	26
E: 0 I: 0 Z: 0					

Road Description	
At Intersection:	4
At Driveway Access:	1
Intersection Related:	2
Non Intersection:	19
In Alley:	0
Roundabout:	0
Ramp:	0
Parking Lot:	0
Unknown:	0
Total:	26

Road Conditions	
Dry:	22
Wet:	2
Muddy:	0
Snowy:	0
Icy:	1
Slushy:	0
Foreign Material:	0
With Road Treatment:	0
Dry w/Icy Road Treatment:	0
Wet w/Icy Road Treatment:	1
Snowy w/Icy Road Treatment:	0
Icy w/Icy Road Treatment:	0
Slushy w/Icy Road Treatment:	0
Unknown:	0
Total:	26

ADT: 10,233 Length: 1.01



Colorado Department of Transportation
DiExSys™ Roadway Safety Systems
Detailed Summary of Crashes Report

10/12/2020

Job #: 20201012153130

Location: 83A Begin: 23.75 End: 24.75 From:01/01/2014 To:12/31/2019

Vehicle Type	Veh 1	Veh 2	Veh 3
Passenger Car/Van:	9	6	3
Passenger Car/Van w/Trl:	0	0	0
Pickup Truck/Utility Van:	3	3	0
Pickup Truck/Utility Van w/Trl:	2	0	0
SUV:	8	6	1
SUV w/Trl:	0	0	0
Truck 10k lbs or Less:	0	0	0
Trucks > 10k lbs/Bus > 15 People:	0	1	0
School Bus < 15 People:	0	0	0
Non School Bus < 15 People:	0	0	0
Motorhome:	0	0	0
Motorcycle:	3	0	0
Bicycle:	0	0	0
Motorized Bicycle:	0	0	0
Farm Equipment:	0	0	0
Hit and Run - Unknown:	1	0	0
Other:	0	0	0
Unknown:	0	0	0
Total:	26	16	4

Vehicle Movement	Veh 1	Veh 2	Veh 3
Going Straight:	16	8	3
Slowing:	0	4	0
Stopped in Traffic:	0	2	1
Making Right Turn:	0	0	0
Making Left Turn:	1	1	0
Making U-Turn:	1	0	0
Passing:	1	0	0
Backing:	0	0	0
Enter/Leave Parked Position:	0	0	0
Starting in Traffic:	0	0	0
Parked:	0	0	0
Changing Lanes:	0	0	0
Avoiding Object/Veh in Road:	1	1	0
Weaving:	0	0	0
Wrong Way:	1	0	0
Other:	5	0	0
Unknown:	0	0	0
Total:	26	16	4

Contributing Factor	Veh 1	Veh 2	Veh 3
No Apparent Contributing Factor:	9	14	4
Asleep at the Wheel:	2	0	0
Illness:	1	0	0
Distracted by Passenger:	0	0	0
Driver Inexperience:	1	0	0
Driver Fatigue:	0	0	0
Driver Preoccupied:	4	0	0
Driver Unfamiliar with Area:	3	0	0
Driver Emotionally Upset:	0	0	0
Evading Law Enforcement Officer:	0	0	0
Physical Disability:	0	0	0
Unknown:	6	2	0
Total:	26	16	4

Direction	Veh 1	Veh 2	Veh 3
North:	13	10	3
Northeast:	1	0	0
East:	0	0	0
Southeast:	0	0	0
South:	12	6	1
Southwest:	0	0	0
West:	0	0	0
Northwest:	0	0	0
Unknown:	0	0	0
Total:	26	16	4

Condition of Driver	Veh 1	Veh 2	Veh 3
No Impairment Suspected:	24	15	4
Alcohol Involved:	2	0	0
RX, Medication, or Drugs Involved:	0	1	0
Illegal Drugs Involved:	0	0	0
Alcohol and Drugs Involved:	0	0	0
Driver/Pedestrian not Observed:	0	0	0
Unknown:	0	0	0
Total:	26	16	4

ADT: 10,233 Length: 1.01



Colorado Department of Transportation
DiExSys™ Roadway Safety Systems
Detailed Summary of Crashes Report

10/13/2020

Job #: 20201013150944

Location: 83A Begin: 24.75 End: 25.75 From:01/01/2014 To:12/31/2019

Severity

PDO:	13	
INJ:	8	12 :Injured
FAT:	1	1 :Killed
Total:	22	

Number of Vehicles

One Vehicle:	8
Two Vehicles:	13
Three or More:	1
Unknown:	0
Total:	22

Location

On Road:	16
Off Road Left:	5
Off Road Right:	1
Off Road at Tee:	0
Off in Median:	0
Unknown:	0
Total:	22

Lighting Conditions

Daylight:	17
Dawn or Dusk:	0
Dark - Lighted:	0
Dark - Unlighted:	5
Unknown:	0
Total:	22

Weather Conditions

None:	18
Rain:	1
Snow/Sleet/Hail:	2
Fog:	0
Dust:	0
Wind:	0
Unknown:	1
Total:	22

Crash Rates

PDO:	0.58 *	* MVMT
INJ:	0.36 *	** 100 MVMT
FAT:	4.46 **	
Total:	0.98 *	

Crash Type

Overtuning:	3	Bridge Abutment:	0
Other Non Collision:	0	Column/Pier:	0
Pedestrians:	0	Culvert/Headwall:	0
Broadside:	2	Embankment:	0
Head On:	0	Curb:	0
Rear End:	9	Delineator Post:	0
Sideswipe (Same):	1	Fence:	0
Sideswipe (Opposite):	0	Tree:	3
Approach Turn:	1	Large Boulders or Rocks:	0
Overtaking Turn:	0	Barricade:	0
Parked Motor Vehicle:	0	Wall/Building:	0
Railway Vehicle:	0	Crash Cushion:	0
Bicycle:	0	Mailbox:	0
Motorized Bicycle:	0	Other Fixed Object:	0
Domestic Animal:	1	Total Fixed Objects:	4
Wild Animal:	1	Rocks in Roadway:	0
Light/Utility Pole:	0	Vehicle Cargo/Debris:	0
Traffic Signal Pole:	0	Road Maintenance Equipment:	0
Sign:	1	Involving Other Object:	0
Bridge Rail:	0	Total Other Objects:	0
Guard Rail:	0	Unknown:	0
Cable Rail:	0	Total:	22
Concrete Barrier:	0		

Mainline/Ramps/Frontage Roads

Mainline:	22	Frontage/Ramp Intersections
Crossroad (A):	0	M: 0 N: 0 O: 0 P: 0
Ramps		
B: 0 F: 0 J: 0	Left Frontage Rd (L):	0
C: 0 G: 0 K: 0	Rt Frontage Rd (R):	0
D: 0 H: 0 T: 0	HOV Lanes (V):	0
E: 0 I: 0 Z: 0	Unknown:	0
	Total:	22

Road Description

At Intersection:	3
At Driveway Access:	2
Intersection Related:	2
Non Intersection:	15
In Alley:	0
Roundabout:	0
Ramp:	0
Parking Lot:	0
Unknown:	0
Total:	22

Road Conditions

Dry:	19
Wet:	1
Muddy:	0
Snowy:	0
Icy:	2
Slushy:	0
Foreign Material:	0
With Road Treatment:	0
Dry w/Icy Road Treatment:	0
Wet w/Icy Road Treatment:	0
Snowy w/Icy Road Treatment:	0
Icy w/Icy Road Treatment:	0
Slushy w/Icy Road Treatment:	0
Unknown:	0
Total:	22

ADT: 10,233 Length: 1.00



Colorado Department of Transportation
DiExSys™ Roadway Safety Systems
Detailed Summary of Crashes Report

10/13/2020

Job #: 20201013150944

Location: 83A **Begin: 24.75** **End: 25.75** **From:01/01/2014** **To:12/31/2019**

Vehicle Type	Veh 1	Veh 2	Veh 3
Passenger Car/Van:	11	6	1
Passenger Car/Van w/Trl:	0	0	0
Pickup Truck/Utility Van:	2	3	0
Pickup Truck/Utility Van w/Trl:	0	1	0
SUV:	7	4	0
SUV w/Trl:	0	0	0
Truck 10k lbs or Less:	0	0	0
Trucks > 10k lbs/Bus > 15 People:	0	0	0
School Bus < 15 People:	0	0	0
Non School Bus < 15 People:	0	0	0
Motorhome:	0	0	0
Motorcycle:	2	0	0
Bicycle:	0	0	0
Motorized Bicycle:	0	0	0
Farm Equipment:	0	0	0
Hit and Run - Unknown:	0	0	0
Other:	0	0	0
Unknown:	0	0	0
Total:	22	14	1

Vehicle Movement	Veh 1	Veh 2	Veh 3
Going Straight:	13	3	0
Slowing:	1	2	0
Stopped in Traffic:	0	7	1
Making Right Turn:	0	1	0
Making Left Turn:	1	1	0
Making U-Turn:	1	0	0
Passing:	1	0	0
Backing:	0	0	0
Enter/Leave Parked Position:	0	0	0
Starting in Traffic:	0	0	0
Parked:	0	0	0
Changing Lanes:	0	0	0
Avoiding Object/Veh in Road:	1	0	0
Weaving:	0	0	0
Wrong Way:	0	0	0
Other:	4	0	0
Unknown:	0	0	0
Total:	22	14	1

Contributing Factor	Veh 1	Veh 2	Veh 3
No Apparent Contributing Factor:	5	11	1
Asleep at the Wheel:	1	0	0
Illness:	2	0	0
Distracted by Passenger:	0	0	0
Driver Inexperience:	2	0	0
Driver Fatigue:	1	0	0
Driver Preoccupied:	7	0	0
Driver Unfamiliar with Area:	0	0	0
Driver Emotionally Upset:	0	0	0
Evading Law Enforcement Officer:	0	0	0
Physical Disability:	0	0	0
Unknown:	4	3	0
Total:	22	14	1

Direction	Veh 1	Veh 2	Veh 3
North:	14	8	1
Northeast:	0	0	0
East:	1	1	0
Southeast:	0	0	0
South:	7	5	0
Southwest:	0	0	0
West:	0	0	0
Northwest:	0	0	0
Unknown:	0	0	0
Total:	22	14	1

Condition of Driver	Veh 1	Veh 2	Veh 3
No Impairment Suspected:	21	14	1
Alcohol Involved:	1	0	0
RX, Medication, or Drugs Involved:	0	0	0
Illegal Drugs Involved:	0	0	0
Alcohol and Drugs Involved:	0	0	0
Driver/Pedestrian not Observed:	0	0	0
Unknown:	0	0	0
Total:	22	14	1

ADT: 10,233 Length: 1.00



Colorado Department of Transportation
DiExSys™ Roadway Safety Systems
Detailed Summary of Crashes Report

10/14/2020

Job #: 20201014094756

Location: 83A **Begin: 25.75** **End: 26.75** **From:01/01/2014** **To:12/31/2019**

Severity	
PDO:	28
INJ:	19 38 :Injured
FAT:	1 1 :Killed
Total:	48

Number of Vehicles	
One Vehicle:	2
Two Vehicles:	41
Three or More:	5
Unknown:	0
Total:	48

Location	
On Road:	46
Off Road Left:	1
Off Road Right:	1
Off Road at Tee:	0
Off in Median:	0
Unknown:	0
Total:	48

Lighting Conditions	
Daylight:	35
Dawn or Dusk:	1
Dark - Lighted:	6
Dark - Unlighted:	6
Unknown:	0
Total:	48

Weather Conditions	
None:	39
Rain:	2
Snow/Sleet/Hail:	5
Fog:	2
Dust:	0
Wind:	0
Unknown:	0
Total:	48

Crash Rates	
PDO:	1.40 * * MVMT
INJ:	0.95 * ** 100 MVMT
FAT:	5.01 **
Total:	2.40 *

Crash Type			
Overtuning:	1	Bridge Abutment:	0
Other Non Collision:	0	Column/Pier:	0
Pedestrians:	0	Culvert/Headwall:	0
Broadside:	8	Embankment:	0
Head On:	0	Curb:	0
Rear End:	30	Delineator Post:	0
Sideswipe (Same):	2	Fence:	0
Sideswipe (Opposite):	1	Tree:	0
Approach Turn:	5	Large Boulders or Rocks:	0
Overtaking Turn:	0	Barricade:	0
Parked Motor Vehicle:	0	Wall/Building:	0
Railway Vehicle:	0	Crash Cushion:	0
Bicycle:	0	Mailbox:	0
Motorized Bicycle:	0	Other Fixed Object:	0
Domestic Animal:	0	Total Fixed Objects:	0
Wild Animal:	0	Rocks in Roadway:	0
Light/Utility Pole:	0	Vehicle Cargo/Debris:	0
Traffic Signal Pole:	0	Road Maintenance Equipment:	0
Sign:	0	Involving Other Object:	1
Bridge Rail:	0	Total Other Objects:	1
Guard Rail:	0	Unknown:	0
Cable Rail:	0	Total:	48
Concrete Barrier:	0		

Mainline/Ramps/Frontage Roads		Frontage/Ramp Intersections			
Mainline:	48	M:	0	N:	0
Crossroad (A):	0	O:	0	P:	0
Ramps		Total: 48			
B:	0	F:	0	J:	0
C:	0	G:	0	K:	0
D:	0	H:	0	T:	0
E:	0	I:	0	Z:	0
		Left Frontage Rd (L):	0		
		Rt Frontage Rd (R):	0		
		HOV Lanes (V):	0		
		Unknown:	0		

Road Description	
At Intersection:	24
At Driveway Access:	1
Intersection Related:	17
Non Intersection:	6
In Alley:	0
Roundabout:	0
Ramp:	0
Parking Lot:	0
Unknown:	0
Total:	48

Road Conditions	
Dry:	38
Wet:	3
Muddy:	0
Snowy:	5
Icy:	1
Slushy:	1
Foreign Material:	0
With Road Treatment:	0
Dry w/Icy Road Treatment:	0
Wet w/Icy Road Treatment:	0
Snowy w/Icy Road Treatment:	0
Icy w/Icy Road Treatment:	0
Slushy w/Icy Road Treatment:	0
Unknown:	0
Total:	48

ADT: 9,445 **Length: 0.96**



Colorado Department of Transportation
DiExSys™ Roadway Safety Systems
Detailed Summary of Crashes Report

10/14/2020

Job #: 20201014094756

Location: 83A Begin: 25.75 End: 26.75 From:01/01/2014 To:12/31/2019

Vehicle Type	Veh 1	Veh 2	Veh 3
Passenger Car/Van:	18	18	2
Passenger Car/Van w/Trl:	0	0	0
Pickup Truck/Utility Van:	7	9	1
Pickup Truck/Utility Van w/Trl:	0	0	0
SUV:	19	17	2
SUV w/Trl:	0	0	0
Truck 10k lbs or Less:	0	0	0
Trucks > 10k lbs/Bus > 15 People:	2	1	0
School Bus < 15 People:	0	0	0
Non School Bus < 15 People:	0	0	0
Motorhome:	0	0	0
Motorcycle:	1	1	0
Bicycle:	0	0	0
Motorized Bicycle:	0	0	0
Farm Equipment:	0	0	0
Hit and Run - Unknown:	0	0	0
Other:	1	0	0
Unknown:	0	0	0
Total:	48	46	5

Vehicle Movement	Veh 1	Veh 2	Veh 3
Going Straight:	30	12	0
Slowing:	0	4	1
Stopped in Traffic:	1	28	4
Making Right Turn:	5	0	0
Making Left Turn:	5	2	0
Making U-Turn:	1	0	0
Passing:	1	0	0
Backing:	0	0	0
Enter/Leave Parked Position:	0	0	0
Starting in Traffic:	0	0	0
Parked:	0	0	0
Changing Lanes:	1	0	0
Avoiding Object/Veh in Road:	0	0	0
Weaving:	0	0	0
Wrong Way:	0	0	0
Other:	4	0	0
Unknown:	0	0	0
Total:	48	46	5

Contributing Factor	Veh 1	Veh 2	Veh 3
No Apparent Contributing Factor:	13	43	5
Asleep at the Wheel:	0	0	0
Illness:	1	0	0
Distracted by Passenger:	2	0	0
Driver Inexperience:	6	0	0
Driver Fatigue:	0	0	0
Driver Preoccupied:	13	0	0
Driver Unfamiliar with Area:	1	0	0
Driver Emotionally Upset:	0	0	0
Evading Law Enforcement Officer:	0	0	0
Physical Disability:	0	0	0
Unknown:	12	3	0
Total:	48	46	5

Direction	Veh 1	Veh 2	Veh 3
North:	23	15	3
Northeast:	0	0	0
East:	1	2	0
Southeast:	0	0	0
South:	19	21	1
Southwest:	0	0	0
West:	5	8	1
Northwest:	0	0	0
Unknown:	0	0	0
Total:	48	46	5

Condition of Driver	Veh 1	Veh 2	Veh 3
No Impairment Suspected:	44	46	5
Alcohol Involved:	4	0	0
RX, Medication, or Drugs Involved:	0	0	0
Illegal Drugs Involved:	0	0	0
Alcohol and Drugs Involved:	0	0	0
Driver/Pedestrian not Observed:	0	0	0
Unknown:	0	0	0
Total:	48	46	5

ADT: 9,445 Length: 0.96



Colorado Department of Transportation
DiExSys™ Roadway Safety Systems
Detailed Summary of Crashes Report

10/14/2020

Job #: 20201014100405

Location: 83A Begin: 26.75 End: 27.75 From:01/01/2014 To:12/31/2019

Severity	
PDO:	13
INJ:	9 13 :Injured
FAT:	1 1 :Killed
Total:	23

Number of Vehicles	
One Vehicle:	7
Two Vehicles:	16
Three or More:	0
Unknown:	0
Total:	23

Location	
On Road:	17
Off Road Left:	1
Off Road Right:	5
Off Road at Tee:	0
Off in Median:	0
Unknown:	0
Total:	23

Lighting Conditions	
Daylight:	16
Dawn or Dusk:	1
Dark - Lighted:	0
Dark - Unlighted:	6
Unknown:	0
Total:	23

Weather Conditions	
None:	21
Rain:	0
Snow/Sleet/Hail:	1
Fog:	0
Dust:	0
Wind:	1
Unknown:	0
Total:	23

Crash Rates	
PDO:	0.65* * MVMT
INJ:	0.45* ** 100 MVMT
FAT:	5.02**
Total:	1.15*

Crash Type			
Overtuning:	1	Bridge Abutment:	0
Other Non Collision:	0	Column/Pier:	0
Pedestrians:	0	Culvert/Headwall:	0
Broadside:	0	Embankment:	1
Head On:	0	Curb:	0
Rear End:	10	Delineator Post:	1
Sideswipe (Same):	4	Fence:	1
Sideswipe (Opposite):	1	Tree:	0
Approach Turn:	0	Large Boulders or Rocks:	0
Overtaking Turn:	1	Barricade:	0
Parked Motor Vehicle:	0	Wall/Building:	0
Railway Vehicle:	0	Crash Cushion:	0
Bicycle:	0	Mailbox:	0
Motorized Bicycle:	0	Other Fixed Object:	0
Domestic Animal:	0	Total Fixed Objects:	5
Wild Animal:	1	Rocks in Roadway:	0
Light/Utility Pole:	1	Vehicle Cargo/Debris:	0
Traffic Signal Pole:	0	Road Maintenance Equipment:	0
Sign:	1	Involving Other Object:	0
Bridge Rail:	0	Total Other Objects:	0
Guard Rail:	0	Unknown:	0
Cable Rail:	0	Total:	23
Concrete Barrier:	0		

Mainline/Ramps/Frontage Roads		Frontage/Ramp Intersections			
Mainline:	23	M:	0	N:	0
Crossroad (A):	0	O:	0	P:	0
Ramps		Total: 23			
B: 0	F: 0	J: 0	K: 0	L: 0	M: 0
C: 0	G: 0	H: 0	I: 0	N: 0	O: 0
D: 0	H: 0	T: 0	U: 0	V: 0	W: 0
E: 0	I: 0	Z: 0			
		Left Frontage Rd (L):	0		
		Rt Frontage Rd (R):	0		
		HOV Lanes (V):	0		
		Unknown:	0		

Road Description	
At Intersection:	2
At Driveway Access:	3
Intersection Related:	3
Non Intersection:	15
In Alley:	0
Roundabout:	0
Ramp:	0
Parking Lot:	0
Unknown:	0
Total:	23

Road Conditions	
Dry:	22
Wet:	0
Muddy:	0
Snowy:	1
Icy:	0
Slushy:	0
Foreign Material:	0
With Road Treatment:	0
Dry w/Icy Road Treatment:	0
Wet w/Icy Road Treatment:	0
Snowy w/Icy Road Treatment:	0
Icy w/Icy Road Treatment:	0
Slushy w/Icy Road Treatment:	0
Unknown:	0
Total:	23

ADT: 9,333 Length: 0.97



Colorado Department of Transportation
DiExSys™ Roadway Safety Systems
Detailed Summary of Crashes Report

10/14/2020

Job #: 20201014100405

Location: 83A **Begin: 26.75** **End: 27.75** **From:01/01/2014** **To:12/31/2019**

Vehicle Type	Veh 1	Veh 2	Veh 3
Passenger Car/Van:	13	5	0
Passenger Car/Van w/Trl:	0	0	0
Pickup Truck/Utility Van:	6	2	0
Pickup Truck/Utility Van w/Trl:	1	0	0
SUV:	2	7	0
SUV w/Trl:	0	0	0
Truck 10k lbs or Less:	0	0	0
Trucks > 10k lbs/Bus > 15 People:	0	1	0
School Bus < 15 People:	0	0	0
Non School Bus < 15 People:	0	0	0
Motorhome:	0	0	0
Motorcycle:	0	1	0
Bicycle:	0	0	0
Motorized Bicycle:	0	0	0
Farm Equipment:	0	0	0
Hit and Run - Unknown:	1	0	0
Other:	0	0	0
Unknown:	0	0	0
Total:	23	16	0

Vehicle Movement	Veh 1	Veh 2	Veh 3
Going Straight:	13	5	0
Slowing:	1	3	0
Stopped in Traffic:	0	4	0
Making Right Turn:	0	0	0
Making Left Turn:	0	3	0
Making U-Turn:	0	0	0
Passing:	5	0	0
Backing:	0	0	0
Enter/Leave Parked Position:	0	0	0
Starting in Traffic:	0	0	0
Parked:	0	0	0
Changing Lanes:	0	0	0
Avoiding Object/Veh in Road:	0	1	0
Weaving:	1	0	0
Wrong Way:	0	0	0
Other:	3	0	0
Unknown:	0	0	0
Total:	23	16	0

Contributing Factor	Veh 1	Veh 2	Veh 3
No Apparent Contributing Factor:	8	14	0
Asleep at the Wheel:	3	0	0
Illness:	0	0	0
Distracted by Passenger:	0	0	0
Driver Inexperience:	1	0	0
Driver Fatigue:	1	0	0
Driver Preoccupied:	3	1	0
Driver Unfamiliar with Area:	0	0	0
Driver Emotionally Upset:	0	0	0
Evading Law Enforcement Officer:	0	0	0
Physical Disability:	0	0	0
Unknown:	7	1	0
Total:	23	16	0

Direction	Veh 1	Veh 2	Veh 3
North:	11	8	0
Northeast:	0	0	0
East:	0	0	0
Southeast:	0	0	0
South:	12	8	0
Southwest:	0	0	0
West:	0	0	0
Northwest:	0	0	0
Unknown:	0	0	0
Total:	23	16	0

Condition of Driver	Veh 1	Veh 2	Veh 3
No Impairment Suspected:	22	16	0
Alcohol Involved:	1	0	0
RX, Medication, or Drugs Involved:	0	0	0
Illegal Drugs Involved:	0	0	0
Alcohol and Drugs Involved:	0	0	0
Driver/Pedestrian not Observed:	0	0	0
Unknown:	0	0	0
Total:	23	16	0

ADT: 9,333 Length: 0.97



Colorado Department of Transportation
DiExSys™ Roadway Safety Systems
Detailed Summary of Crashes Report

10/14/2020

Job #: 20201014101453

Location: 83A Begin: 27.75 End: 28.75 From:01/01/2014 To:12/31/2019

Severity	
PDO:	18
INJ:	36 73 :Injured
FAT:	1 1 :Killed
Total:	55

Number of Vehicles	
One Vehicle:	7
Two Vehicles:	42
Three or More:	6
Unknown:	0
Total:	55

Location	
On Road:	49
Off Road Left:	1
Off Road Right:	5
Off Road at Tee:	0
Off in Median:	0
Unknown:	0
Total:	55

Lighting Conditions	
Daylight:	43
Dawn or Dusk:	2
Dark - Lighted:	7
Dark - Unlighted:	3
Unknown:	0
Total:	55

Weather Conditions	
None:	51
Rain:	2
Snow/Sleet/Hail:	0
Fog:	1
Dust:	0
Wind:	0
Unknown:	1
Total:	55

Crash Rates	
PDO:	1.05* * MVMT
INJ:	2.10* ** 100 MVMT
FAT:	5.83**
Total:	3.21*

Crash Type			
Overtuning:	3	Bridge Abutment:	0
Other Non Collision:	0	Column/Pier:	0
Pedestrians:	0	Culvert/Headwall:	0
Broadside:	24	Embankment:	1
Head On:	0	Curb:	1
Rear End:	9	Delineator Post:	0
Sideswipe (Same):	1	Fence:	2
Sideswipe (Opposite):	1	Tree:	0
Approach Turn:	11	Large Boulders or Rocks:	0
Overtaking Turn:	1	Barricade:	0
Parked Motor Vehicle:	0	Wall/Building:	0
Railway Vehicle:	0	Crash Cushion:	0
Bicycle:	0	Mailbox:	0
Motorized Bicycle:	0	Other Fixed Object:	0
Domestic Animal:	0	Total Fixed Objects:	4
Wild Animal:	0	Rocks in Roadway:	0
Light/Utility Pole:	0	Vehicle Cargo/Debris:	1
Traffic Signal Pole:	0	Road Maintenance Equipment:	0
Sign:	0	Involving Other Object:	0
Bridge Rail:	0	Total Other Objects:	1
Guard Rail:	0	Unknown:	0
Cable Rail:	0	Total:	55
Concrete Barrier:	0		

Mainline/Ramps/Frontage Roads		Frontage/Ramp Intersections			
Mainline:	55	M:	0	N:	0
Crossroad (A):	0	O:	0	P:	0
Ramps		Left Frontage Rd (L):	0		
B: 0 F: 0 J: 0		Rt Frontage Rd (R):	0		
C: 0 G: 0 K: 0		HOV Lanes (V):	0		
D: 0 H: 0 T: 0		Unknown:	0	Total:	55
E: 0 I: 0 Z: 0					

Road Description	
At Intersection:	38
At Driveway Access:	1
Intersection Related:	5
Non Intersection:	11
In Alley:	0
Roundabout:	0
Ramp:	0
Parking Lot:	0
Unknown:	0
Total:	55

Road Conditions	
Dry:	49
Wet:	3
Muddy:	0
Snowy:	0
Icy:	1
Slushy:	0
Foreign Material:	1
With Road Treatment:	0
Dry w/Icy Road Treatment:	0
Wet w/Icy Road Treatment:	1
Snowy w/Icy Road Treatment:	0
Icy w/Icy Road Treatment:	0
Slushy w/Icy Road Treatment:	0
Unknown:	0
Total:	55

ADT: 7,804 Length: 1.00



Colorado Department of Transportation
DiExSys™ Roadway Safety Systems
Detailed Summary of Crashes Report

10/14/2020

Job #: 20201014101453

Location: 83A Begin: 27.75 End: 28.75 From:01/01/2014 To:12/31/2019

Vehicle Type	Veh 1	Veh 2	Veh 3
Passenger Car/Van:	20	18	0
Passenger Car/Van w/Trl:	0	1	0
Pickup Truck/Utility Van:	10	7	1
Pickup Truck/Utility Van w/Trl:	2	0	0
SUV:	21	17	5
SUV w/Trl:	0	0	0
Truck 10k lbs or Less:	0	0	0
Trucks > 10k lbs/Bus > 15 People:	0	2	0
School Bus < 15 People:	0	0	0
Non School Bus < 15 People:	0	0	0
Motorhome:	0	0	0
Motorcycle:	2	3	0
Bicycle:	0	0	0
Motorized Bicycle:	0	0	0
Farm Equipment:	0	0	0
Hit and Run - Unknown:	0	0	0
Other:	0	0	0
Unknown:	0	0	0
Total:	55	48	6

Vehicle Movement	Veh 1	Veh 2	Veh 3
Going Straight:	25	36	2
Slowing:	1	4	0
Stopped in Traffic:	0	5	4
Making Right Turn:	2	0	0
Making Left Turn:	19	2	0
Making U-Turn:	2	0	0
Passing:	1	0	0
Backing:	1	0	0
Enter/Leave Parked Position:	0	0	0
Starting in Traffic:	0	0	0
Parked:	0	0	0
Changing Lanes:	0	0	0
Avoiding Object/Veh in Road:	0	1	0
Weaving:	2	0	0
Wrong Way:	0	0	0
Other:	2	0	0
Unknown:	0	0	0
Total:	55	48	6

Contributing Factor	Veh 1	Veh 2	Veh 3
No Apparent Contributing Factor:	18	40	6
Asleep at the Wheel:	0	0	0
Illness:	0	0	0
Distracted by Passenger:	1	0	0
Driver Inexperience:	12	1	0
Driver Fatigue:	0	0	0
Driver Preoccupied:	10	0	0
Driver Unfamiliar with Area:	2	0	0
Driver Emotionally Upset:	0	0	0
Evading Law Enforcement Officer:	0	0	0
Physical Disability:	0	0	0
Unknown:	12	7	0
Total:	55	48	6

Direction	Veh 1	Veh 2	Veh 3
North:	18	16	3
Northeast:	0	0	0
East:	17	2	1
Southeast:	1	1	0
South:	12	26	1
Southwest:	0	0	0
West:	7	3	1
Northwest:	0	0	0
Unknown:	0	0	0
Total:	55	48	6

Condition of Driver	Veh 1	Veh 2	Veh 3
No Impairment Suspected:	52	47	6
Alcohol Involved:	1	1	0
RX, Medication, or Drugs Involved:	2	0	0
Illegal Drugs Involved:	0	0	0
Alcohol and Drugs Involved:	0	0	0
Driver/Pedestrian not Observed:	0	0	0
Unknown:	0	0	0
Total:	55	48	6

ADT: 7,804 Length: 1.00



Colorado Department of Transportation
DiExSys™ Roadway Safety Systems
Detailed Summary of Crashes Report

10/14/2020

Job #: 20201014102541

Location: 83A Begin: 28.75 End: 30.24 From:01/01/2014 To:12/31/2019

Severity

PDO:	13	
INJ:	19	30 :Injured
FAT:	0	0 :Killed
Total:	32	

Number of Vehicles

One Vehicle:	10
Two Vehicles:	19
Three or More:	3
Unknown:	0
Total:	32

Location

On Road:	21
Off Road Left:	3
Off Road Right:	8
Off Road at Tee:	0
Off in Median:	0
Unknown:	0
Total:	32

Lighting Conditions

Daylight:	22
Dawn or Dusk:	1
Dark - Lighted:	1
Dark - Unlighted:	8
Unknown:	0
Total:	32

Weather Conditions

None:	29
Rain:	0
Snow/Sleet/Hail:	2
Fog:	0
Dust:	0
Wind:	1
Unknown:	0
Total:	32

Crash Rates

PDO:	0.59 *	* MVMT
INJ:	0.86 *	** 100 MVMT
FAT:	0.00 **	
Total:	1.45 *	

Crash Type

Overturning:	7	Bridge Abutment:	0
Other Non Collision:	0	Column/Pier:	0
Pedestrians:	0	Culvert/Headwall:	0
Broadside:	9	Embankment:	2
Head On:	0	Curb:	0
Rear End:	7	Delineator Post:	0
Sideswipe (Same):	0	Fence:	1
Sideswipe (Opposite):	0	Tree:	1
Approach Turn:	3	Large Boulders or Rocks:	0
Overtaking Turn:	0	Barricade:	0
Parked Motor Vehicle:	0	Wall/Building:	0
Railway Vehicle:	0	Crash Cushion:	0
Bicycle:	0	Mailbox:	0
Motorized Bicycle:	0	Other Fixed Object:	0
Domestic Animal:	0	Total Fixed Objects:	4
Wild Animal:	0	Rocks in Roadway:	0
Light/Utility Pole:	0	Vehicle Cargo/Debris:	2
Traffic Signal Pole:	0	Road Maintenance Equipment:	0
Sign:	0	Involving Other Object:	0
Bridge Rail:	0	Total Other Objects:	2
Guard Rail:	0	Unknown:	0
Cable Rail:	0	Total:	32
Concrete Barrier:	0		

Mainline/Ramps/Frontage Roads

Mainline:	32	Frontage/Ramp Intersections
Crossroad (A):	0	M: 0 N: 0 O: 0 P: 0
Ramps		
B: 0 F: 0 J: 0	Left Frontage Rd (L):	0
C: 0 G: 0 K: 0	Rt Frontage Rd (R):	0
D: 0 H: 0 T: 0	HOV Lanes (V):	0
E: 0 I: 0 Z: 0	Unknown:	0
	Total:	32

Road Description

At Intersection:	14
At Driveway Access:	1
Intersection Related:	3
Non Intersection:	14
In Alley:	0
Roundabout:	0
Ramp:	0
Parking Lot:	0
Unknown:	0
Total:	32

Road Conditions

Dry:	26
Wet:	2
Muddy:	0
Snowy:	0
Icy:	1
Slushy:	0
Foreign Material:	0
With Road Treatment:	0
Dry w/Icy Road Treatment:	0
Wet w/Icy Road Treatment:	1
Snowy w/Icy Road Treatment:	1
Icy w/Icy Road Treatment:	1
Slushy w/Icy Road Treatment:	0
Unknown:	0
Total:	32

ADT: 7,067 Length: 1.42



Colorado Department of Transportation
DiExSys™ Roadway Safety Systems
Detailed Summary of Crashes Report

10/14/2020

Job #: 20201014102541

Location: 83A Begin: 28.75 End: 30.24 From:01/01/2014 To:12/31/2019

Vehicle Type	Veh 1	Veh 2	Veh 3
Passenger Car/Van:	14	4	1
Passenger Car/Van w/Trl:	0	0	0
Pickup Truck/Utility Van:	8	5	0
Pickup Truck/Utility Van w/Trl:	1	1	0
SUV:	7	10	1
SUV w/Trl:	1	0	0
Truck 10k lbs or Less:	0	0	0
Trucks > 10k lbs/Bus > 15 People:	0	1	0
School Bus < 15 People:	0	0	0
Non School Bus < 15 People:	0	0	0
Motorhome:	0	0	0
Motorcycle:	1	1	0
Bicycle:	0	0	1
Motorized Bicycle:	0	0	0
Farm Equipment:	0	0	0
Hit and Run - Unknown:	0	0	0
Other:	0	0	0
Unknown:	0	0	0
Total:	32	22	3

Vehicle Movement	Veh 1	Veh 2	Veh 3
Going Straight:	18	13	0
Slowing:	2	3	0
Stopped in Traffic:	0	3	2
Making Right Turn:	3	1	0
Making Left Turn:	3	0	0
Making U-Turn:	0	1	0
Passing:	1	1	0
Backing:	0	0	0
Enter/Leave Parked Position:	1	0	0
Starting in Traffic:	0	0	0
Parked:	0	0	0
Changing Lanes:	0	0	0
Avoiding Object/Veh in Road:	1	0	0
Weaving:	0	0	0
Wrong Way:	0	0	0
Other:	3	0	1
Unknown:	0	0	0
Total:	32	22	3

Contributing Factor	Veh 1	Veh 2	Veh 3
No Apparent Contributing Factor:	6	19	3
Asleep at the Wheel:	1	0	0
Illness:	0	0	0
Distracted by Passenger:	1	0	0
Driver Inexperience:	7	0	0
Driver Fatigue:	1	0	0
Driver Preoccupied:	5	1	0
Driver Unfamiliar with Area:	1	1	0
Driver Emotionally Upset:	0	0	0
Evading Law Enforcement Officer:	0	0	0
Physical Disability:	0	0	0
Unknown:	10	1	0
Total:	32	22	3

Direction	Veh 1	Veh 2	Veh 3
North:	17	10	2
Northeast:	0	0	0
East:	6	1	0
Southeast:	0	0	0
South:	7	9	0
Southwest:	0	0	0
West:	2	2	1
Northwest:	0	0	0
Unknown:	0	0	0
Total:	32	22	3

Condition of Driver	Veh 1	Veh 2	Veh 3
No Impairment Suspected:	30	22	3
Alcohol Involved:	2	0	0
RX, Medication, or Drugs Involved:	0	0	0
Illegal Drugs Involved:	0	0	0
Alcohol and Drugs Involved:	0	0	0
Driver/Pedestrian not Observed:	0	0	0
Unknown:	0	0	0
Total:	32	22	3

ADT: 7,067 Length: 1.42

C.2. Intersection Summary



Colorado Department of Transportation
DiExSys™ Roadway Safety Systems
Detailed Summary of Crashes Report

10/01/2020

Job #: 20201001105325

Location: 83A **Begin: 22.00** **End: 22.20** **From:12/31/2014** **To:12/31/2019**

Severity	
PDO:	5
INJ:	2 4 :Injured
FAT:	0 0 :Killed
Total:	7

Number of Vehicles	
One Vehicle:	1
Two Vehicles:	6
Three or More:	0
Unknown:	0
Total:	7

Location	
On Road:	6
Off Road Left:	0
Off Road Right:	1
Off Road at Tee:	0
Off in Median:	0
Unknown:	0
Total:	7

Lighting Conditions	
Daylight:	6
Dawn or Dusk:	0
Dark - Lighted:	0
Dark - Unlighted:	1
Unknown:	0
Total:	7

Weather Conditions	
None:	7
Rain:	0
Snow/Sleet/Hail:	0
Fog:	0
Dust:	0
Wind:	0
Unknown:	0
Total:	7

Crash Rates	
PDO:	0.81 * * MVMT
INJ:	0.32 * ** 100 MVMT
FAT:	0.00 **
Total:	1.13 *

Crash Type			
Overturing:	1	Bridge Abutment:	0
Other Non Collision:	0	Column/Pier:	0
Pedestrians:	0	Culvert/Headwall:	0
Broadside:	1	Embankment:	0
Head On:	0	Curb:	0
Rear End:	2	Delineator Post:	0
Sideswipe (Same):	0	Fence:	0
Sideswipe (Opposite):	0	Tree:	0
Approach Turn:	2	Large Boulders or Rocks:	0
Overtaking Turn:	1	Barricade:	0
Parked Motor Vehicle:	0	Wall/Building:	0
Railway Vehicle:	0	Crash Cushion:	0
Bicycle:	0	Mailbox:	0
Motorized Bicycle:	0	Other Fixed Object:	0
Domestic Animal:	0	Total Fixed Objects:	0
Wild Animal:	0	Rocks in Roadway:	0
Light/Utility Pole:	0	Vehicle Cargo/Debris:	0
Traffic Signal Pole:	0	Road Maintenance Equipment:	0
Sign:	0	Involving Other Object:	0
Bridge Rail:	0	Total Other Objects:	0
Guard Rail:	0	Unknown:	0
Cable Rail:	0	Total:	7
Concrete Barrier:	0		

Mainline/Ramps/Frontage Roads		Frontage/Ramp Intersections			
Mainline:	7	M:	0	N:	0
Crossroad (A):	0	O:	0	P:	0
Ramps		Total: 7			
B:	0	F:	0	J:	0
C:	0	G:	0	K:	0
D:	0	H:	0	T:	0
E:	0	I:	0	Z:	0
		Left Frontage Rd (L):	0		
		Rt Frontage Rd (R):	0		
		HOV Lanes (V):	0		
		Unknown:	0		

Road Description	
At Intersection:	7
At Driveway Access:	0
Intersection Related:	0
Non Intersection:	0
In Alley:	0
Roundabout:	0
Ramp:	0
Parking Lot:	0
Unknown:	0
Total:	7

Road Conditions	
Dry:	7
Wet:	0
Muddy:	0
Snowy:	0
Icy:	0
Slushy:	0
Foreign Material:	0
With Road Treatment:	0
Dry w/Icy Road Treatment:	0
Wet w/Icy Road Treatment:	0
Snowy w/Icy Road Treatment:	0
Icy w/Icy Road Treatment:	0
Slushy w/Icy Road Treatment:	0
Unknown:	0
Total:	7

ADT: 12,667 **Length: 0.26**



Colorado Department of Transportation
DiExSys™ Roadway Safety Systems
Detailed Summary of Crashes Report

10/01/2020

Job #: 20201001105325

Location: 83A Begin: 22.00 End: 22.20 From:12/31/2014 To:12/31/2019

Vehicle Type	Veh 1	Veh 2	Veh 3
Passenger Car/Van:	2	3	0
Passenger Car/Van w/Trl:	0	0	0
Pickup Truck/Utility Van:	2	0	0
Pickup Truck/Utility Van w/Trl:	0	0	0
SUV:	3	3	0
SUV w/Trl:	0	0	0
Truck 10k lbs or Less:	0	0	0
Trucks > 10k lbs/Bus > 15 People:	0	0	0
School Bus < 15 People:	0	0	0
Non School Bus < 15 People:	0	0	0
Motorhome:	0	0	0
Motorcycle:	0	0	0
Bicycle:	0	0	0
Motorized Bicycle:	0	0	0
Farm Equipment:	0	0	0
Hit and Run - Unknown:	0	0	0
Other:	0	0	0
Unknown:	0	0	0
Total:	7	6	0

Vehicle Movement	Veh 1	Veh 2	Veh 3
Going Straight:	2	2	0
Slowing:	0	0	0
Stopped in Traffic:	0	2	0
Making Right Turn:	1	0	0
Making Left Turn:	2	2	0
Making U-Turn:	2	0	0
Passing:	0	0	0
Backing:	0	0	0
Enter/Leave Parked Position:	0	0	0
Starting in Traffic:	0	0	0
Parked:	0	0	0
Changing Lanes:	0	0	0
Avoiding Object/Veh in Road:	0	0	0
Weaving:	0	0	0
Wrong Way:	0	0	0
Other:	0	0	0
Unknown:	0	0	0
Total:	7	6	0

Contributing Factor	Veh 1	Veh 2	Veh 3
No Apparent Contributing Factor:	2	6	0
Asleep at the Wheel:	0	0	0
Illness:	0	0	0
Distracted by Passenger:	0	0	0
Driver Inexperience:	0	0	0
Driver Fatigue:	1	0	0
Driver Preoccupied:	3	0	0
Driver Unfamiliar with Area:	0	0	0
Driver Emotionally Upset:	0	0	0
Evading Law Enforcement Officer:	0	0	0
Physical Disability:	0	0	0
Unknown:	1	0	0
Total:	7	6	0

Direction	Veh 1	Veh 2	Veh 3
North:	3	4	0
Northeast:	0	0	0
East:	2	1	0
Southeast:	0	0	0
South:	1	1	0
Southwest:	0	0	0
West:	1	0	0
Northwest:	0	0	0
Unknown:	0	0	0
Total:	7	6	0

Condition of Driver	Veh 1	Veh 2	Veh 3
No Impairment Suspected:	7	6	0
Alcohol Involved:	0	0	0
RX, Medication, or Drugs Involved:	0	0	0
Illegal Drugs Involved:	0	0	0
Alcohol and Drugs Involved:	0	0	0
Driver/Pedestrian not Observed:	0	0	0
Unknown:	0	0	0
Total:	7	6	0

ADT: 12,667 Length: 0.26



Colorado Department of Transportation
DiExSys™ Roadway Safety Systems
Detailed Summary of Crashes Report

10/01/2020

Job #: 20201001110148

Location: 83A Begin: 22.37 End: 22.89 From:12/31/2014 To:12/31/2019

Severity	
PDO:	11
INJ:	4 7 :Injured
FAT:	0 0 :Killed
Total:	15

Number of Vehicles	
One Vehicle:	1
Two Vehicles:	12
Three or More:	2
Unknown:	0
Total:	15

Location	
On Road:	14
Off Road Left:	1
Off Road Right:	0
Off Road at Tee:	0
Off in Median:	0
Unknown:	0
Total:	15

Lighting Conditions	
Daylight:	14
Dawn or Dusk:	0
Dark - Lighted:	1
Dark - Unlighted:	0
Unknown:	0
Total:	15

Weather Conditions	
None:	12
Rain:	2
Snow/Sleet/Hail:	0
Fog:	0
Dust:	0
Wind:	0
Unknown:	1
Total:	15

Crash Rates	
PDO:	1.00 * * MVMT
INJ:	0.37 * ** 100 MVMT
FAT:	0.00 **
Total:	1.37 *

Crash Type			
Overtuning:	0	Bridge Abutment:	0
Other Non Collision:	0	Column/Pier:	0
Pedestrians:	0	Culvert/Headwall:	0
Broadside:	2	Embankment:	0
Head On:	0	Curb:	0
Rear End:	8	Delineator Post:	0
Sideswipe (Same):	2	Fence:	1
Sideswipe (Opposite):	0	Tree:	0
Approach Turn:	2	Large Boulders or Rocks:	0
Overtaking Turn:	0	Barricade:	0
Parked Motor Vehicle:	0	Wall/Building:	0
Railway Vehicle:	0	Crash Cushion:	0
Bicycle:	0	Mailbox:	0
Motorized Bicycle:	0	Other Fixed Object:	0
Domestic Animal:	0	Total Fixed Objects:	1
Wild Animal:	0	Rocks in Roadway:	0
Light/Utility Pole:	0	Vehicle Cargo/Debris:	0
Traffic Signal Pole:	0	Road Maintenance Equipment:	0
Sign:	0	Involving Other Object:	0
Bridge Rail:	0	Total Other Objects:	0
Guard Rail:	0	Unknown:	0
Cable Rail:	0	Total:	15
Concrete Barrier:	0		

Mainline/Ramps/Frontage Roads		Frontage/Ramp Intersections			
Mainline:	15	M:	0	N:	0
Crossroad (A):	0	O:	0	P:	0
Ramps		Total: 15			
B: 0	F: 0	J: 0	Left Frontage Rd (L): 0		
C: 0	G: 0	K: 0	Rt Frontage Rd (R): 0		
D: 0	H: 0	T: 0	HOV Lanes (V): 0		
E: 0	I: 0	Z: 0	Unknown: 0		

Road Description	
At Intersection:	8
At Driveway Access:	0
Intersection Related:	7
Non Intersection:	0
In Alley:	0
Roundabout:	0
Ramp:	0
Parking Lot:	0
Unknown:	0
Total:	15

Road Conditions	
Dry:	12
Wet:	3
Muddy:	0
Snowy:	0
Icy:	0
Slushy:	0
Foreign Material:	0
With Road Treatment:	0
Dry w/Icy Road Treatment:	0
Wet w/Icy Road Treatment:	0
Snowy w/Icy Road Treatment:	0
Icy w/Icy Road Treatment:	0
Slushy w/Icy Road Treatment:	0
Unknown:	0
Total:	15

ADT: 12,667 Length: 0.47



Colorado Department of Transportation
DiExSys™ Roadway Safety Systems
Detailed Summary of Crashes Report

10/01/2020

Job #: 20201001110148

Location: 83A Begin: 22.37 End: 22.89 From:12/31/2014 To:12/31/2019

Vehicle Type	Veh 1	Veh 2	Veh 3
Passenger Car/Van:	9	7	0
Passenger Car/Van w/Trl:	0	0	0
Pickup Truck/Utility Van:	0	1	0
Pickup Truck/Utility Van w/Trl:	0	0	0
SUV:	6	5	2
SUV w/Trl:	0	0	0
Truck 10k lbs or Less:	0	0	0
Trucks > 10k lbs/Bus > 15 People:	0	1	0
School Bus < 15 People:	0	0	0
Non School Bus < 15 People:	0	0	0
Motorhome:	0	0	0
Motorcycle:	0	0	0
Bicycle:	0	0	0
Motorized Bicycle:	0	0	0
Farm Equipment:	0	0	0
Hit and Run - Unknown:	0	0	0
Other:	0	0	0
Unknown:	0	0	0
Total:	15	14	2

Vehicle Movement	Veh 1	Veh 2	Veh 3
Going Straight:	5	6	0
Slowing:	1	0	0
Stopped in Traffic:	0	7	2
Making Right Turn:	1	0	0
Making Left Turn:	5	1	0
Making U-Turn:	0	0	0
Passing:	0	0	0
Backing:	0	0	0
Enter/Leave Parked Position:	0	0	0
Starting in Traffic:	0	0	0
Parked:	0	0	0
Changing Lanes:	2	0	0
Avoiding Object/Veh in Road:	1	0	0
Weaving:	0	0	0
Wrong Way:	0	0	0
Other:	0	0	0
Unknown:	0	0	0
Total:	15	14	2

Contributing Factor	Veh 1	Veh 2	Veh 3
No Apparent Contributing Factor:	3	12	2
Asleep at the Wheel:	0	0	0
Illness:	1	0	0
Distracted by Passenger:	0	0	0
Driver Inexperience:	3	0	0
Driver Fatigue:	0	0	0
Driver Preoccupied:	3	0	0
Driver Unfamiliar with Area:	1	0	0
Driver Emotionally Upset:	0	0	0
Evading Law Enforcement Officer:	0	0	0
Physical Disability:	0	0	0
Unknown:	4	2	0
Total:	15	14	2

Direction	Veh 1	Veh 2	Veh 3
North:	3	1	1
Northeast:	0	0	0
East:	6	4	0
Southeast:	0	0	0
South:	6	9	1
Southwest:	0	0	0
West:	0	0	0
Northwest:	0	0	0
Unknown:	0	0	0
Total:	15	14	2

Condition of Driver	Veh 1	Veh 2	Veh 3
No Impairment Suspected:	14	14	2
Alcohol Involved:	1	0	0
RX, Medication, or Drugs Involved:	0	0	0
Illegal Drugs Involved:	0	0	0
Alcohol and Drugs Involved:	0	0	0
Driver/Pedestrian not Observed:	0	0	0
Unknown:	0	0	0
Total:	15	14	2

ADT: 12,667 Length: 0.47



Colorado Department of Transportation
DiExSys™ Roadway Safety Systems
Detailed Summary of Crashes Report

10/01/2020

Job #: 20201001104858

Location: 83A Begin: 21.14 End: 21.34 From:12/31/2014 To:12/31/2019

Severity	
PDO:	11
INJ:	9 16 :Injured
FAT:	0 0 :Killed
Total:	20

Number of Vehicles	
One Vehicle:	2
Two Vehicles:	15
Three or More:	3
Unknown:	0
Total:	20

Location	
On Road:	18
Off Road Left:	0
Off Road Right:	1
Off Road at Tee:	1
Off in Median:	0
Unknown:	0
Total:	20

Lighting Conditions	
Daylight:	15
Dawn or Dusk:	0
Dark - Lighted:	5
Dark - Unlighted:	0
Unknown:	0
Total:	20

Weather Conditions	
None:	18
Rain:	2
Snow/Sleet/Hail:	0
Fog:	0
Dust:	0
Wind:	0
Unknown:	0
Total:	20

Crash Rates	
PDO:	1.70 * * MVMT
INJ:	1.39 * ** 100 MVMT
FAT:	0.00 **
Total:	3.09 *

Crash Type			
Overtuning:	0	Bridge Abutment:	0
Other Non Collision:	0	Column/Pier:	0
Pedestrians:	0	Culvert/Headwall:	0
Broadside:	1	Embankment:	0
Head On:	0	Curb:	0
Rear End:	8	Delineator Post:	0
Sideswipe (Same):	0	Fence:	0
Sideswipe (Opposite):	0	Tree:	0
Approach Turn:	8	Large Boulders or Rocks:	0
Overtaking Turn:	1	Barricade:	0
Parked Motor Vehicle:	0	Wall/Building:	0
Railway Vehicle:	0	Crash Cushion:	0
Bicycle:	0	Mailbox:	0
Motorized Bicycle:	0	Other Fixed Object:	0
Domestic Animal:	0	Total Fixed Objects:	2
Wild Animal:	0	Rocks in Roadway:	0
Light/Utility Pole:	0	Vehicle Cargo/Debris:	0
Traffic Signal Pole:	0	Road Maintenance Equipment:	0
Sign:	0	Involving Other Object:	0
Bridge Rail:	0	Total Other Objects:	0
Guard Rail:	2	Unknown:	0
Cable Rail:	0	Total:	20
Concrete Barrier:	0		

Mainline/Ramps/Frontage Roads		Frontage/Ramp Intersections			
Mainline:	20	M:	0	N:	0
Crossroad (A):	0	O:	0	P:	0
Ramps		Total: 20			
B:	0	F:	0	J:	0
C:	0	G:	0	K:	0
D:	0	H:	0	T:	0
E:	0	I:	0	Z:	0
		Left Frontage Rd (L):	0		
		Rt Frontage Rd (R):	0		
		HOV Lanes (V):	0		
		Unknown:	0		

Road Description	
At Intersection:	11
At Driveway Access:	0
Intersection Related:	9
Non Intersection:	0
In Alley:	0
Roundabout:	0
Ramp:	0
Parking Lot:	0
Unknown:	0
Total:	20

Road Conditions	
Dry:	17
Wet:	2
Muddy:	0
Snowy:	0
Icy:	0
Slushy:	0
Foreign Material:	0
With Road Treatment:	0
Dry w/Icy Road Treatment:	0
Wet w/Icy Road Treatment:	1
Snowy w/Icy Road Treatment:	0
Icy w/Icy Road Treatment:	0
Slushy w/Icy Road Treatment:	0
Unknown:	0
Total:	20

ADT: 15,734 Length: 0.22



Colorado Department of Transportation
DiExSys™ Roadway Safety Systems
Detailed Summary of Crashes Report

10/01/2020

Job #: 20201001104858

Location: 83A **Begin: 21.14** **End: 21.34** **From:12/31/2014** **To:12/31/2019**

Vehicle Type	Veh 1	Veh 2	Veh 3
Passenger Car/Van:	6	7	3
Passenger Car/Van w/Trl:	0	0	0
Pickup Truck/Utility Van:	4	2	0
Pickup Truck/Utility Van w/Trl:	0	0	0
SUV:	9	8	0
SUV w/Trl:	0	1	0
Truck 10k lbs or Less:	0	0	0
Trucks > 10k lbs/Bus > 15 People:	1	0	0
School Bus < 15 People:	0	0	0
Non School Bus < 15 People:	0	0	0
Motorhome:	0	0	0
Motorcycle:	0	0	0
Bicycle:	0	0	0
Motorized Bicycle:	0	0	0
Farm Equipment:	0	0	0
Hit and Run - Unknown:	0	0	0
Other:	0	0	0
Unknown:	0	0	0
Total:	20	18	3

Vehicle Movement	Veh 1	Veh 2	Veh 3
Going Straight:	6	10	0
Slowing:	2	2	0
Stopped in Traffic:	0	6	3
Making Right Turn:	2	0	0
Making Left Turn:	9	0	0
Making U-Turn:	1	0	0
Passing:	0	0	0
Backing:	0	0	0
Enter/Leave Parked Position:	0	0	0
Starting in Traffic:	0	0	0
Parked:	0	0	0
Changing Lanes:	0	0	0
Avoiding Object/Veh in Road:	0	0	0
Weaving:	0	0	0
Wrong Way:	0	0	0
Other:	0	0	0
Unknown:	0	0	0
Total:	20	18	3

Contributing Factor	Veh 1	Veh 2	Veh 3
No Apparent Contributing Factor:	5	16	3
Asleep at the Wheel:	0	0	0
Illness:	0	0	0
Distracted by Passenger:	0	0	0
Driver Inexperience:	3	0	0
Driver Fatigue:	0	0	0
Driver Preoccupied:	5	0	0
Driver Unfamiliar with Area:	0	0	0
Driver Emotionally Upset:	0	0	0
Evading Law Enforcement Officer:	0	0	0
Physical Disability:	0	0	0
Unknown:	7	2	0
Total:	20	18	3

Direction	Veh 1	Veh 2	Veh 3
North:	3	12	1
Northeast:	0	0	0
East:	0	0	0
Southeast:	0	0	0
South:	13	5	0
Southwest:	1	0	0
West:	3	1	2
Northwest:	0	0	0
Unknown:	0	0	0
Total:	20	18	3

Condition of Driver	Veh 1	Veh 2	Veh 3
No Impairment Suspected:	20	18	3
Alcohol Involved:	0	0	0
RX, Medication, or Drugs Involved:	0	0	0
Illegal Drugs Involved:	0	0	0
Alcohol and Drugs Involved:	0	0	0
Driver/Pedestrian not Observed:	0	0	0
Unknown:	0	0	0
Total:	20	18	3

ADT: 15,734 **Length: 0.22**



Colorado Department of Transportation
DiExSys™ Roadway Safety Systems
Detailed Summary of Crashes Report

10/12/2020

Job #: 20201012075820

Location: 83A Begin: 23.03 End: 23.23 From:01/01/2014 To:12/31/2019

Severity	
PDO:	4
INJ:	2 2 :Injured
FAT:	0 0 :Killed
Total:	6

Number of Vehicles	
One Vehicle:	2
Two Vehicles:	4
Three or More:	0
Unknown:	0
Total:	6

Location	
On Road:	4
Off Road Left:	0
Off Road Right:	2
Off Road at Tee:	0
Off in Median:	0
Unknown:	0
Total:	6

Lighting Conditions	
Daylight:	4
Dawn or Dusk:	1
Dark - Lighted:	1
Dark - Unlighted:	0
Unknown:	0
Total:	6

Weather Conditions	
None:	5
Rain:	1
Snow/Sleet/Hail:	0
Fog:	0
Dust:	0
Wind:	0
Unknown:	0
Total:	6

Crash Rates	
PDO:	0.69 * * MVMT
INJ:	0.34 * ** 100 MVMT
FAT:	0.00 **
Total:	1.03 *

Crash Type			
Overtuning:	0	Bridge Abutment:	0
Other Non Collision:	0	Column/Pier:	0
Pedestrians:	0	Culvert/Headwall:	0
Broadside:	1	Embankment:	0
Head On:	0	Curb:	0
Rear End:	1	Delineator Post:	0
Sideswipe (Same):	1	Fence:	0
Sideswipe (Opposite):	0	Tree:	0
Approach Turn:	0	Large Boulders or Rocks:	1
Overtaking Turn:	1	Barricade:	0
Parked Motor Vehicle:	0	Wall/Building:	0
Railway Vehicle:	0	Crash Cushion:	0
Bicycle:	0	Mailbox:	0
Motorized Bicycle:	0	Other Fixed Object:	0
Domestic Animal:	0	Total Fixed Objects:	2
Wild Animal:	0	Rocks in Roadway:	0
Light/Utility Pole:	1	Vehicle Cargo/Debris:	0
Traffic Signal Pole:	0	Road Maintenance Equipment:	0
Sign:	0	Involving Other Object:	0
Bridge Rail:	0	Total Other Objects:	0
Guard Rail:	0	Unknown:	0
Cable Rail:	0	Total:	6
Concrete Barrier:	0		

Mainline/Ramps/Frontage Roads		Frontage/Ramp Intersections			
Mainline:	6	M:	0	N:	0
Crossroad (A):	0	O:	0	P:	0
Ramps		Total: 6			
B:	0	F:	0	J:	0
C:	0	G:	0	K:	0
D:	0	H:	0	T:	0
E:	0	I:	0	Z:	0
		Left Frontage Rd (L):	0		
		Rt Frontage Rd (R):	0		
		HOV Lanes (V):	0		
		Unknown:	0		

Road Description	
At Intersection:	3
At Driveway Access:	0
Intersection Related:	3
Non Intersection:	0
In Alley:	0
Roundabout:	0
Ramp:	0
Parking Lot:	0
Unknown:	0
Total:	6

Road Conditions	
Dry:	4
Wet:	1
Muddy:	0
Snowy:	0
Icy:	0
Slushy:	0
Foreign Material:	0
With Road Treatment:	0
Dry w/Icy Road Treatment:	1
Wet w/Icy Road Treatment:	0
Snowy w/Icy Road Treatment:	0
Icy w/Icy Road Treatment:	0
Slushy w/Icy Road Treatment:	0
Unknown:	0
Total:	6

ADT: 11,621 Length: 0.22



Colorado Department of Transportation
DiExSys™ Roadway Safety Systems
Detailed Summary of Crashes Report

10/12/2020

Job #: 20201012075820

Location: 83A Begin: 23.03 End: 23.23 From:01/01/2014 To:12/31/2019

Vehicle Type	Veh 1	Veh 2	Veh 3
Passenger Car/Van:	3	1	0
Passenger Car/Van w/Trl:	0	0	0
Pickup Truck/Utility Van:	0	0	0
Pickup Truck/Utility Van w/Trl:	1	0	0
SUV:	2	3	0
SUV w/Trl:	0	0	0
Truck 10k lbs or Less:	0	0	0
Trucks > 10k lbs/Bus > 15 People:	0	0	0
School Bus < 15 People:	0	0	0
Non School Bus < 15 People:	0	0	0
Motorhome:	0	0	0
Motorcycle:	0	0	0
Bicycle:	0	0	0
Motorized Bicycle:	0	0	0
Farm Equipment:	0	0	0
Hit and Run - Unknown:	0	0	0
Other:	0	0	0
Unknown:	0	0	0
Total:	6	4	0

Vehicle Movement	Veh 1	Veh 2	Veh 3
Going Straight:	2	1	0
Slowing:	0	1	0
Stopped in Traffic:	0	2	0
Making Right Turn:	2	0	0
Making Left Turn:	0	0	0
Making U-Turn:	0	0	0
Passing:	0	0	0
Backing:	0	0	0
Enter/Leave Parked Position:	0	0	0
Starting in Traffic:	0	0	0
Parked:	0	0	0
Changing Lanes:	1	0	0
Avoiding Object/Veh in Road:	0	0	0
Weaving:	0	0	0
Wrong Way:	0	0	0
Other:	1	0	0
Unknown:	0	0	0
Total:	6	4	0

Contributing Factor	Veh 1	Veh 2	Veh 3
No Apparent Contributing Factor:	1	3	0
Asleep at the Wheel:	0	0	0
Illness:	0	0	0
Distracted by Passenger:	0	0	0
Driver Inexperience:	1	0	0
Driver Fatigue:	1	0	0
Driver Preoccupied:	1	0	0
Driver Unfamiliar with Area:	1	0	0
Driver Emotionally Upset:	0	0	0
Evading Law Enforcement Officer:	0	0	0
Physical Disability:	0	0	0
Unknown:	1	1	0
Total:	6	4	0

Direction	Veh 1	Veh 2	Veh 3
North:	1	1	0
Northeast:	0	0	0
East:	3	2	0
Southeast:	0	0	0
South:	2	1	0
Southwest:	0	0	0
West:	0	0	0
Northwest:	0	0	0
Unknown:	0	0	0
Total:	6	4	0

Condition of Driver	Veh 1	Veh 2	Veh 3
No Impairment Suspected:	6	4	0
Alcohol Involved:	0	0	0
RX, Medication, or Drugs Involved:	0	0	0
Illegal Drugs Involved:	0	0	0
Alcohol and Drugs Involved:	0	0	0
Driver/Pedestrian not Observed:	0	0	0
Unknown:	0	0	0
Total:	6	4	0

ADT: 11,621 Length: 0.22



Colorado Department of Transportation
DiExSys™ Roadway Safety Systems
Detailed Summary of Crashes Report

10/12/2020

Job #: 20201012154256

Location: 83A **Begin: 23.92** **End: 24.12** **From:01/01/2014** **To:12/31/2019**

Severity	
PDO:	0
INJ:	3 4 :Injured
FAT:	0 0 :Killed
Total:	3

Number of Vehicles	
One Vehicle:	1
Two Vehicles:	1
Three or More:	1
Unknown:	0
Total:	3

Location	
On Road:	3
Off Road Left:	0
Off Road Right:	0
Off Road at Tee:	0
Off in Median:	0
Unknown:	0
Total:	3

Lighting Conditions	
Daylight:	3
Dawn or Dusk:	0
Dark - Lighted:	0
Dark - Unlighted:	0
Unknown:	0
Total:	3

Weather Conditions	
None:	3
Rain:	0
Snow/Sleet/Hail:	0
Fog:	0
Dust:	0
Wind:	0
Unknown:	0
Total:	3

Crash Rates	
PDO:	0.00 * * MVMT
INJ:	0.55 * ** 100 MVMT
FAT:	0.00 **
Total:	0.55 *

Crash Type	
Overtuning:	1
Other Non Collision:	0
Pedestrians:	0
Broadside:	0
Head On:	0
Rear End:	2
Sideswipe (Same):	0
Sideswipe (Opposite):	0
Approach Turn:	0
Overtaking Turn:	0
Parked Motor Vehicle:	0
Railway Vehicle:	0
Bicycle:	0
Motorized Bicycle:	0
Domestic Animal:	0
Wild Animal:	0
Light/Utility Pole:	0
Traffic Signal Pole:	0
Sign:	0
Bridge Rail:	0
Guard Rail:	0
Cable Rail:	0
Concrete Barrier:	0
Bridge Abutment:	0
Column/Pier:	0
Culvert/Headwall:	0
Embankment:	0
Curb:	0
Delineator Post:	0
Fence:	0
Tree:	0
Large Boulders or Rocks:	0
Barricade:	0
Wall/Building:	0
Crash Cushion:	0
Mailbox:	0
Other Fixed Object:	0
Total Fixed Objects:	0
Rocks in Roadway:	0
Vehicle Cargo/Debris:	0
Road Maintenance Equipment:	0
Involving Other Object:	0
Total Other Objects:	0
Unknown:	0
Total:	3

Mainline/Ramps/Frontage Roads	
Mainline:	3
Crossroad (A):	0
Total:	3

Frontage/Ramp Intersections	
M:	0
N:	0
O:	0
P:	0
Total:	3

Ramps	
B:	0
C:	0
D:	0
E:	0
F:	0
G:	0
H:	0
I:	0
J:	0
K:	0
L:	0
M:	0
N:	0
O:	0
P:	0
Q:	0
R:	0
S:	0
T:	0
U:	0
V:	0
W:	0
X:	0
Y:	0
Z:	0
Unknown:	0
Total:	3

Road Description	
At Intersection:	1
At Driveway Access:	0
Intersection Related:	2
Non Intersection:	0
In Alley:	0
Roundabout:	0
Ramp:	0
Parking Lot:	0
Unknown:	0
Total:	3

Road Conditions	
Dry:	3
Wet:	0
Muddy:	0
Snowy:	0
Icy:	0
Slushy:	0
Foreign Material:	0
With Road Treatment:	0
Dry w/Icy Road Treatment:	0
Wet w/Icy Road Treatment:	0
Snowy w/Icy Road Treatment:	0
Icy w/Icy Road Treatment:	0
Slushy w/Icy Road Treatment:	0
Unknown:	0
Total:	3

ADT: 10,233 Length: 0.24



Colorado Department of Transportation
DiExSys™ Roadway Safety Systems
Detailed Summary of Crashes Report

10/12/2020

Job #: 20201012154256

Location: 83A Begin: 23.92 End: 24.12 From:01/01/2014 To:12/31/2019

Vehicle Type	Veh 1	Veh 2	Veh 3
Passenger Car/Van:	2	2	1
Passenger Car/Van w/Trl:	0	0	0
Pickup Truck/Utility Van:	0	0	0
Pickup Truck/Utility Van w/Trl:	0	0	0
SUV:	0	0	0
SUV w/Trl:	0	0	0
Truck 10k lbs or Less:	0	0	0
Trucks > 10k lbs/Bus > 15 People:	0	0	0
School Bus < 15 People:	0	0	0
Non School Bus < 15 People:	0	0	0
Motorhome:	0	0	0
Motorcycle:	1	0	0
Bicycle:	0	0	0
Motorized Bicycle:	0	0	0
Farm Equipment:	0	0	0
Hit and Run - Unknown:	0	0	0
Other:	0	0	0
Unknown:	0	0	0
Total:	3	2	1

Vehicle Movement	Veh 1	Veh 2	Veh 3
Going Straight:	2	0	0
Slowing:	0	1	0
Stopped in Traffic:	0	1	1
Making Right Turn:	0	0	0
Making Left Turn:	0	0	0
Making U-Turn:	0	0	0
Passing:	0	0	0
Backing:	0	0	0
Enter/Leave Parked Position:	0	0	0
Starting in Traffic:	0	0	0
Parked:	0	0	0
Changing Lanes:	0	0	0
Avoiding Object/Veh in Road:	0	0	0
Weaving:	0	0	0
Wrong Way:	0	0	0
Other:	1	0	0
Unknown:	0	0	0
Total:	3	2	1

Contributing Factor	Veh 1	Veh 2	Veh 3
No Apparent Contributing Factor:	1	2	1
Asleep at the Wheel:	0	0	0
Illness:	0	0	0
Distracted by Passenger:	0	0	0
Driver Inexperience:	1	0	0
Driver Fatigue:	0	0	0
Driver Preoccupied:	1	0	0
Driver Unfamiliar with Area:	0	0	0
Driver Emotionally Upset:	0	0	0
Evading Law Enforcement Officer:	0	0	0
Physical Disability:	0	0	0
Unknown:	0	0	0
Total:	3	2	1

Direction	Veh 1	Veh 2	Veh 3
North:	3	2	1
Northeast:	0	0	0
East:	0	0	0
Southeast:	0	0	0
South:	0	0	0
Southwest:	0	0	0
West:	0	0	0
Northwest:	0	0	0
Unknown:	0	0	0
Total:	3	2	1

Condition of Driver	Veh 1	Veh 2	Veh 3
No Impairment Suspected:	3	2	1
Alcohol Involved:	0	0	0
RX, Medication, or Drugs Involved:	0	0	0
Illegal Drugs Involved:	0	0	0
Alcohol and Drugs Involved:	0	0	0
Driver/Pedestrian not Observed:	0	0	0
Unknown:	0	0	0
Total:	3	2	1

ADT: 10,233 Length: 0.24



Colorado Department of Transportation
DiExSys™ Roadway Safety Systems
Detailed Summary of Crashes Report

10/12/2020

Job #: 20201012154631

Location: 83A **Begin: 24.50** **End: 24.70** **From:01/01/2014** **To:12/31/2019**

Severity	
PDO:	0
INJ:	2 3 :Injured
FAT:	0 0 :Killed
Total:	2

Number of Vehicles	
One Vehicle:	0
Two Vehicles:	2
Three or More:	0
Unknown:	0
Total:	2

Location	
On Road:	2
Off Road Left:	0
Off Road Right:	0
Off Road at Tee:	0
Off in Median:	0
Unknown:	0
Total:	2

Lighting Conditions	
Daylight:	2
Dawn or Dusk:	0
Dark - Lighted:	0
Dark - Unlighted:	0
Unknown:	0
Total:	2

Weather Conditions	
None:	2
Rain:	0
Snow/Sleet/Hail:	0
Fog:	0
Dust:	0
Wind:	0
Unknown:	0
Total:	2

Crash Rates	
PDO:	0.00 * * MVMT
INJ:	0.47 * ** 100 MVMT
FAT:	0.00 **
Total:	0.47 *

Crash Type			
Overtuning:	0	Bridge Abutment:	0
Other Non Collision:	0	Column/Pier:	0
Pedestrians:	0	Culvert/Headwall:	0
Broadside:	0	Embankment:	0
Head On:	0	Curb:	0
Rear End:	1	Delineator Post:	0
Sideswipe (Same):	0	Fence:	0
Sideswipe (Opposite):	0	Tree:	0
Approach Turn:	1	Large Boulders or Rocks:	0
Overtaking Turn:	0	Barricade:	0
Parked Motor Vehicle:	0	Wall/Building:	0
Railway Vehicle:	0	Crash Cushion:	0
Bicycle:	0	Mailbox:	0
Motorized Bicycle:	0	Other Fixed Object:	0
Domestic Animal:	0	Total Fixed Objects:	0
Wild Animal:	0	Rocks in Roadway:	0
Light/Utility Pole:	0	Vehicle Cargo/Debris:	0
Traffic Signal Pole:	0	Road Maintenance Equipment:	0
Sign:	0	Involving Other Object:	0
Bridge Rail:	0	Total Other Objects:	0
Guard Rail:	0	Unknown:	0
Cable Rail:	0	Total:	2
Concrete Barrier:	0		

Mainline/Ramps/Frontage Roads		Frontage/Ramp Intersections			
Mainline:	2	M:	0	N:	0
Crossroad (A):	0	O:	0	P:	0
Ramps		Total: 2			
B:	0	F:	0	J:	0
C:	0	G:	0	K:	0
D:	0	H:	0	T:	0
E:	0	I:	0	Z:	0
		Left Frontage Rd (L):	0		
		Rt Frontage Rd (R):	0		
		HOV Lanes (V):	0		
		Unknown:	0		

Road Description	
At Intersection:	2
At Driveway Access:	0
Intersection Related:	0
Non Intersection:	0
In Alley:	0
Roundabout:	0
Ramp:	0
Parking Lot:	0
Unknown:	0
Total:	2

Road Conditions	
Dry:	2
Wet:	0
Muddy:	0
Snowy:	0
Icy:	0
Slushy:	0
Foreign Material:	0
With Road Treatment:	0
Dry w/Icy Road Treatment:	0
Wet w/Icy Road Treatment:	0
Snowy w/Icy Road Treatment:	0
Icy w/Icy Road Treatment:	0
Slushy w/Icy Road Treatment:	0
Unknown:	0
Total:	2

ADT: 10,233 **Length: 0.18**



Colorado Department of Transportation
DiExSys™ Roadway Safety Systems
Detailed Summary of Crashes Report

10/12/2020

Job #: 20201012154631

Location: 83A Begin: 24.50 End: 24.70 From:01/01/2014 To:12/31/2019

Vehicle Type	Veh 1	Veh 2	Veh 3
Passenger Car/Van:	1	0	0
Passenger Car/Van w/Trl:	0	0	0
Pickup Truck/Utility Van:	0	0	0
Pickup Truck/Utility Van w/Trl:	0	0	0
SUV:	1	2	0
SUV w/Trl:	0	0	0
Truck 10k lbs or Less:	0	0	0
Trucks > 10k lbs/Bus > 15 People:	0	0	0
School Bus < 15 People:	0	0	0
Non School Bus < 15 People:	0	0	0
Motorhome:	0	0	0
Motorcycle:	0	0	0
Bicycle:	0	0	0
Motorized Bicycle:	0	0	0
Farm Equipment:	0	0	0
Hit and Run - Unknown:	0	0	0
Other:	0	0	0
Unknown:	0	0	0
Total:	2	2	0

Vehicle Movement	Veh 1	Veh 2	Veh 3
Going Straight:	1	1	0
Slowing:	0	0	0
Stopped in Traffic:	0	0	0
Making Right Turn:	0	0	0
Making Left Turn:	1	1	0
Making U-Turn:	0	0	0
Passing:	0	0	0
Backing:	0	0	0
Enter/Leave Parked Position:	0	0	0
Starting in Traffic:	0	0	0
Parked:	0	0	0
Changing Lanes:	0	0	0
Avoiding Object/Veh in Road:	0	0	0
Weaving:	0	0	0
Wrong Way:	0	0	0
Other:	0	0	0
Unknown:	0	0	0
Total:	2	2	0

Contributing Factor	Veh 1	Veh 2	Veh 3
No Apparent Contributing Factor:	0	2	0
Asleep at the Wheel:	0	0	0
Illness:	0	0	0
Distracted by Passenger:	0	0	0
Driver Inexperience:	0	0	0
Driver Fatigue:	0	0	0
Driver Preoccupied:	0	0	0
Driver Unfamiliar with Area:	1	0	0
Driver Emotionally Upset:	0	0	0
Evading Law Enforcement Officer:	0	0	0
Physical Disability:	0	0	0
Unknown:	1	0	0
Total:	2	2	0

Direction	Veh 1	Veh 2	Veh 3
North:	2	1	0
Northeast:	0	0	0
East:	0	0	0
Southeast:	0	0	0
South:	0	1	0
Southwest:	0	0	0
West:	0	0	0
Northwest:	0	0	0
Unknown:	0	0	0
Total:	2	2	0

Condition of Driver	Veh 1	Veh 2	Veh 3
No Impairment Suspected:	2	2	0
Alcohol Involved:	0	0	0
RX, Medication, or Drugs Involved:	0	0	0
Illegal Drugs Involved:	0	0	0
Alcohol and Drugs Involved:	0	0	0
Driver/Pedestrian not Observed:	0	0	0
Unknown:	0	0	0
Total:	2	2	0

ADT: 10,233 Length: 0.18



Colorado Department of Transportation
 DiExSys™ Roadway Safety Systems
 Detailed Summary of Crashes Report

10/14/2020

Job #: 20201014093843

Location: 83A Begin: 25.06 End: 25.26 From:01/01/2014 To:12/31/2019

Severity

PDO:	1	
INJ:	1	2 :Injured
FAT:	0	0 :Killed
Total:	2	

Number of Vehicles

One Vehicle:	0
Two Vehicles:	2
Three or More:	0
Unknown:	0
Total:	2

Location

On Road:	2
Off Road Left:	0
Off Road Right:	0
Off Road at Tee:	0
Off in Median:	0
Unknown:	0
Total:	2

Lighting Conditions

Daylight:	1
Dawn or Dusk:	0
Dark - Lighted:	0
Dark - Unlighted:	1
Unknown:	0
Total:	2

Weather Conditions

None:	2
Rain:	0
Snow/Sleet/Hail:	0
Fog:	0
Dust:	0
Wind:	0
Unknown:	0
Total:	2

Crash Rates

PDO:	0.20 *	* MVMT
INJ:	0.20 *	** 100 MVMT
FAT:	0.00 **	
Total:	0.40 *	

Crash Type

Overtuning:	0	Bridge Abutment:	0
Other Non Collision:	0	Column/Pier:	0
Pedestrians:	0	Culvert/Headwall:	0
Broadside:	2	Embankment:	0
Head On:	0	Curb:	0
Rear End:	0	Delineator Post:	0
Sideswipe (Same):	0	Fence:	0
Sideswipe (Opposite):	0	Tree:	0
Approach Turn:	0	Large Boulders or Rocks:	0
Overtaking Turn:	0	Barricade:	0
Parked Motor Vehicle:	0	Wall/Building:	0
Railway Vehicle:	0	Crash Cushion:	0
Bicycle:	0	Mailbox:	0
Motorized Bicycle:	0	Other Fixed Object:	0
Domestic Animal:	0	Total Fixed Objects:	0
Wild Animal:	0	Rocks in Roadway:	0
Light/Utility Pole:	0	Vehicle Cargo/Debris:	0
Traffic Signal Pole:	0	Road Maintenance Equipment:	0
Sign:	0	Involving Other Object:	0
Bridge Rail:	0	Total Other Objects:	0
Guard Rail:	0	Unknown:	0
Cable Rail:	0	Total:	2
Concrete Barrier:	0		

Mainline/Ramps/Frontage Roads

Mainline:	2	Frontage/Ramp Intersections
Crossroad (A):	0	M: 0 N: 0 O: 0 P: 0
Ramps		
B: 0 F: 0 J: 0	Left Frontage Rd (L):	0
C: 0 G: 0 K: 0	Rt Frontage Rd (R):	0
D: 0 H: 0 T: 0	HOV Lanes (V):	0
E: 0 I: 0 Z: 0	Unknown:	0
	Total:	2

Road Description

At Intersection:	2
At Driveway Access:	0
Intersection Related:	0
Non Intersection:	0
In Alley:	0
Roundabout:	0
Ramp:	0
Parking Lot:	0
Unknown:	0
Total:	2

Road Conditions

Dry:	2
Wet:	0
Muddy:	0
Snowy:	0
Icy:	0
Slushy:	0
Foreign Material:	0
With Road Treatment:	0
Dry w/Icy Road Treatment:	0
Wet w/Icy Road Treatment:	0
Snowy w/Icy Road Treatment:	0
Icy w/Icy Road Treatment:	0
Slushy w/Icy Road Treatment:	0
Unknown:	0
Total:	2

ADT: 10,233 Length: 0.22



Colorado Department of Transportation
DiExSys™ Roadway Safety Systems
Detailed Summary of Crashes Report

10/14/2020

Job #: 20201014093843

Location: 83A Begin: 25.06 End: 25.26 From:01/01/2014 To:12/31/2019

Vehicle Type	Veh 1	Veh 2	Veh 3
Passenger Car/Van:	2	0	0
Passenger Car/Van w/Trl:	0	0	0
Pickup Truck/Utility Van:	0	1	0
Pickup Truck/Utility Van w/Trl:	0	0	0
SUV:	0	1	0
SUV w/Trl:	0	0	0
Truck 10k lbs or Less:	0	0	0
Trucks > 10k lbs/Bus > 15 People:	0	0	0
School Bus < 15 People:	0	0	0
Non School Bus < 15 People:	0	0	0
Motorhome:	0	0	0
Motorcycle:	0	0	0
Bicycle:	0	0	0
Motorized Bicycle:	0	0	0
Farm Equipment:	0	0	0
Hit and Run - Unknown:	0	0	0
Other:	0	0	0
Unknown:	0	0	0
Total:	2	2	0

Vehicle Movement	Veh 1	Veh 2	Veh 3
Going Straight:	0	1	0
Slowing:	0	0	0
Stopped in Traffic:	0	1	0
Making Right Turn:	0	0	0
Making Left Turn:	1	0	0
Making U-Turn:	0	0	0
Passing:	0	0	0
Backing:	0	0	0
Enter/Leave Parked Position:	0	0	0
Starting in Traffic:	0	0	0
Parked:	0	0	0
Changing Lanes:	0	0	0
Avoiding Object/Veh in Road:	0	0	0
Weaving:	0	0	0
Wrong Way:	0	0	0
Other:	1	0	0
Unknown:	0	0	0
Total:	2	2	0

Contributing Factor	Veh 1	Veh 2	Veh 3
No Apparent Contributing Factor:	0	2	0
Asleep at the Wheel:	0	0	0
Illness:	0	0	0
Distracted by Passenger:	0	0	0
Driver Inexperience:	1	0	0
Driver Fatigue:	0	0	0
Driver Preoccupied:	1	0	0
Driver Unfamiliar with Area:	0	0	0
Driver Emotionally Upset:	0	0	0
Evading Law Enforcement Officer:	0	0	0
Physical Disability:	0	0	0
Unknown:	0	0	0
Total:	2	2	0

Direction	Veh 1	Veh 2	Veh 3
North:	0	0	0
Northeast:	0	0	0
East:	1	1	0
Southeast:	0	0	0
South:	1	1	0
Southwest:	0	0	0
West:	0	0	0
Northwest:	0	0	0
Unknown:	0	0	0
Total:	2	2	0

Condition of Driver	Veh 1	Veh 2	Veh 3
No Impairment Suspected:	2	2	0
Alcohol Involved:	0	0	0
RX, Medication, or Drugs Involved:	0	0	0
Illegal Drugs Involved:	0	0	0
Alcohol and Drugs Involved:	0	0	0
Driver/Pedestrian not Observed:	0	0	0
Unknown:	0	0	0
Total:	2	2	0

ADT: 10,233 Length: 0.22



Colorado Department of Transportation
DiExSys™ Roadway Safety Systems
Detailed Summary of Crashes Report

10/14/2020

Job #: 20201014095205

Location: 83A Begin: 25.77 End: 25.97 From:01/01/2014 To:12/31/2019

Severity	
PDO:	22
INJ:	16 34 :Injured
FAT:	0 0 :Killed
Total:	38

Number of Vehicles	
One Vehicle:	1
Two Vehicles:	33
Three or More:	4
Unknown:	0
Total:	38

Location	
On Road:	37
Off Road Left:	0
Off Road Right:	1
Off Road at Tee:	0
Off in Median:	0
Unknown:	0
Total:	38

Lighting Conditions	
Daylight:	29
Dawn or Dusk:	0
Dark - Lighted:	5
Dark - Unlighted:	4
Unknown:	0
Total:	38

Weather Conditions	
None:	33
Rain:	1
Snow/Sleet/Hail:	3
Fog:	1
Dust:	0
Wind:	0
Unknown:	0
Total:	38

Crash Rates	
PDO:	5.89* * MVMT
INJ:	4.28* ** 100 MVMT
FAT:	0.00**
Total:	10.17*

Crash Type			
Overtuning:	1	Bridge Abutment:	0
Other Non Collision:	0	Column/Pier:	0
Pedestrians:	0	Culvert/Headwall:	0
Broadside:	8	Embankment:	0
Head On:	0	Curb:	0
Rear End:	23	Delineator Post:	0
Sideswipe (Same):	1	Fence:	0
Sideswipe (Opposite):	0	Tree:	0
Approach Turn:	5	Large Boulders or Rocks:	0
Overtaking Turn:	0	Barricade:	0
Parked Motor Vehicle:	0	Wall/Building:	0
Railway Vehicle:	0	Crash Cushion:	0
Bicycle:	0	Mailbox:	0
Motorized Bicycle:	0	Other Fixed Object:	0
Domestic Animal:	0	Total Fixed Objects:	0
Wild Animal:	0	Rocks in Roadway:	0
Light/Utility Pole:	0	Vehicle Cargo/Debris:	0
Traffic Signal Pole:	0	Road Maintenance Equipment:	0
Sign:	0	Involving Other Object:	0
Bridge Rail:	0	Total Other Objects:	0
Guard Rail:	0	Unknown:	0
Cable Rail:	0	Total:	38
Concrete Barrier:	0		

Mainline/Ramps/Frontage Roads		Frontage/Ramp Intersections			
Mainline:	38	M:	0	N:	0
Crossroad (A):	0	O:	0	P:	0
Ramps		Total: 38			
B:	0	F:	0	J:	0
C:	0	G:	0	K:	0
D:	0	H:	0	T:	0
E:	0	I:	0	Z:	0
		Left Frontage Rd (L):	0		
		Rt Frontage Rd (R):	0		
		HOV Lanes (V):	0		
		Unknown:	0		

Road Description	
At Intersection:	24
At Driveway Access:	0
Intersection Related:	14
Non Intersection:	0
In Alley:	0
Roundabout:	0
Ramp:	0
Parking Lot:	0
Unknown:	0
Total:	38

Road Conditions	
Dry:	31
Wet:	2
Muddy:	0
Snowy:	4
Icy:	1
Slushy:	0
Foreign Material:	0
With Road Treatment:	0
Dry w/Icy Road Treatment:	0
Wet w/Icy Road Treatment:	0
Snowy w/Icy Road Treatment:	0
Icy w/Icy Road Treatment:	0
Slushy w/Icy Road Treatment:	0
Unknown:	0
Total:	38

ADT: 9,854 Length: 0.17



Colorado Department of Transportation
DiExSys™ Roadway Safety Systems
Detailed Summary of Crashes Report

10/14/2020

Job #: 20201014095205

Location: 83A Begin: 25.77 End: 25.97 From:01/01/2014 To:12/31/2019

Vehicle Type	Veh 1	Veh 2	Veh 3
Passenger Car/Van:	15	15	1
Passenger Car/Van w/Trl:	0	0	0
Pickup Truck/Utility Van:	6	7	1
Pickup Truck/Utility Van w/Trl:	0	0	0
SUV:	14	14	2
SUV w/Trl:	0	0	0
Truck 10k lbs or Less:	0	0	0
Trucks > 10k lbs/Bus > 15 People:	2	0	0
School Bus < 15 People:	0	0	0
Non School Bus < 15 People:	0	0	0
Motorhome:	0	0	0
Motorcycle:	1	1	0
Bicycle:	0	0	0
Motorized Bicycle:	0	0	0
Farm Equipment:	0	0	0
Hit and Run - Unknown:	0	0	0
Other:	0	0	0
Unknown:	0	0	0
Total:	38	37	4

Vehicle Movement	Veh 1	Veh 2	Veh 3
Going Straight:	25	9	0
Slowing:	0	2	1
Stopped in Traffic:	0	24	3
Making Right Turn:	5	0	0
Making Left Turn:	5	2	0
Making U-Turn:	0	0	0
Passing:	0	0	0
Backing:	0	0	0
Enter/Leave Parked Position:	0	0	0
Starting in Traffic:	0	0	0
Parked:	0	0	0
Changing Lanes:	0	0	0
Avoiding Object/Veh in Road:	0	0	0
Weaving:	0	0	0
Wrong Way:	0	0	0
Other:	3	0	0
Unknown:	0	0	0
Total:	38	37	4

Contributing Factor	Veh 1	Veh 2	Veh 3
No Apparent Contributing Factor:	10	36	4
Asleep at the Wheel:	0	0	0
Illness:	1	0	0
Distracted by Passenger:	2	0	0
Driver Inexperience:	4	0	0
Driver Fatigue:	0	0	0
Driver Preoccupied:	12	0	0
Driver Unfamiliar with Area:	1	0	0
Driver Emotionally Upset:	0	0	0
Evading Law Enforcement Officer:	0	0	0
Physical Disability:	0	0	0
Unknown:	8	1	0
Total:	38	37	4

Direction	Veh 1	Veh 2	Veh 3
North:	21	14	3
Northeast:	0	0	0
East:	1	2	0
Southeast:	0	0	0
South:	11	13	0
Southwest:	0	0	0
West:	5	8	1
Northwest:	0	0	0
Unknown:	0	0	0
Total:	38	37	4

Condition of Driver	Veh 1	Veh 2	Veh 3
No Impairment Suspected:	35	37	4
Alcohol Involved:	3	0	0
RX, Medication, or Drugs Involved:	0	0	0
Illegal Drugs Involved:	0	0	0
Alcohol and Drugs Involved:	0	0	0
Driver/Pedestrian not Observed:	0	0	0
Unknown:	0	0	0
Total:	38	37	4

ADT: 9,854 Length: 0.17



Colorado Department of Transportation
DiExSys™ Roadway Safety Systems
Detailed Summary of Crashes Report

10/14/2020

Job #: 20201014100712

Location: 83A Begin: 27.38 End: 27.58 From:01/01/2014 To:12/31/2019

Severity	
PDO:	2
INJ:	3 6 :Injured
FAT:	0 0 :Killed
Total:	5

Number of Vehicles	
One Vehicle:	0
Two Vehicles:	5
Three or More:	0
Unknown:	0
Total:	5

Location	
On Road:	5
Off Road Left:	0
Off Road Right:	0
Off Road at Tee:	0
Off in Median:	0
Unknown:	0
Total:	5

Lighting Conditions	
Daylight:	3
Dawn or Dusk:	1
Dark - Lighted:	0
Dark - Unlighted:	1
Unknown:	0
Total:	5

Weather Conditions	
None:	4
Rain:	0
Snow/Sleet/Hail:	0
Fog:	0
Dust:	0
Wind:	1
Unknown:	0
Total:	5

Crash Rates	
PDO:	0.49* * MVMT
INJ:	0.74* ** 100 MVMT
FAT:	0.00**
Total:	1.23*

Crash Type			
Overtuning:	0	Bridge Abutment:	0
Other Non Collision:	0	Column/Pier:	0
Pedestrians:	0	Culvert/Headwall:	0
Broadside:	0	Embankment:	0
Head On:	0	Curb:	0
Rear End:	3	Delineator Post:	0
Sideswipe (Same):	2	Fence:	0
Sideswipe (Opposite):	0	Tree:	0
Approach Turn:	0	Large Boulders or Rocks:	0
Overtaking Turn:	0	Barricade:	0
Parked Motor Vehicle:	0	Wall/Building:	0
Railway Vehicle:	0	Crash Cushion:	0
Bicycle:	0	Mailbox:	0
Motorized Bicycle:	0	Other Fixed Object:	0
Domestic Animal:	0	Total Fixed Objects:	0
Wild Animal:	0	Rocks in Roadway:	0
Light/Utility Pole:	0	Vehicle Cargo/Debris:	0
Traffic Signal Pole:	0	Road Maintenance Equipment:	0
Sign:	0	Involving Other Object:	0
Bridge Rail:	0	Total Other Objects:	0
Guard Rail:	0	Unknown:	0
Cable Rail:	0	Total:	5
Concrete Barrier:	0		

Mainline/Ramps/Frontage Roads		Frontage/Ramp Intersections			
Mainline:	5	M:	0	N:	0
Crossroad (A):	0	O:	0	P:	0
Ramps		Total: 5			
B:	0	F:	0	J:	0
C:	0	G:	0	K:	0
D:	0	H:	0	T:	0
E:	0	I:	0	Z:	0
		Left Frontage Rd (L):	0		
		Rt Frontage Rd (R):	0		
		HOV Lanes (V):	0		
		Unknown:	0		

Road Description	
At Intersection:	2
At Driveway Access:	0
Intersection Related:	3
Non Intersection:	0
In Alley:	0
Roundabout:	0
Ramp:	0
Parking Lot:	0
Unknown:	0
Total:	5

Road Conditions	
Dry:	5
Wet:	0
Muddy:	0
Snowy:	0
Icy:	0
Slushy:	0
Foreign Material:	0
With Road Treatment:	0
Dry w/Icy Road Treatment:	0
Wet w/Icy Road Treatment:	0
Snowy w/Icy Road Treatment:	0
Icy w/Icy Road Treatment:	0
Slushy w/Icy Road Treatment:	0
Unknown:	0
Total:	5

ADT: 9,333 Length: 0.19



Colorado Department of Transportation
DiExSys™ Roadway Safety Systems
Detailed Summary of Crashes Report

10/14/2020

Job #: 20201014100712

Location: 83A Begin: 27.38 End: 27.58 From:01/01/2014 To:12/31/2019

Vehicle Type	Veh 1	Veh 2	Veh 3
Passenger Car/Van:	2	1	0
Passenger Car/Van w/Trl:	0	0	0
Pickup Truck/Utility Van:	2	1	0
Pickup Truck/Utility Van w/Trl:	0	0	0
SUV:	0	2	0
SUV w/Trl:	0	0	0
Truck 10k lbs or Less:	0	0	0
Trucks > 10k lbs/Bus > 15 People:	0	1	0
School Bus < 15 People:	0	0	0
Non School Bus < 15 People:	0	0	0
Motorhome:	0	0	0
Motorcycle:	0	0	0
Bicycle:	0	0	0
Motorized Bicycle:	0	0	0
Farm Equipment:	0	0	0
Hit and Run - Unknown:	1	0	0
Other:	0	0	0
Unknown:	0	0	0
Total:	5	5	0

Vehicle Movement	Veh 1	Veh 2	Veh 3
Going Straight:	3	0	0
Slowing:	0	1	0
Stopped in Traffic:	0	2	0
Making Right Turn:	0	0	0
Making Left Turn:	0	2	0
Making U-Turn:	0	0	0
Passing:	2	0	0
Backing:	0	0	0
Enter/Leave Parked Position:	0	0	0
Starting in Traffic:	0	0	0
Parked:	0	0	0
Changing Lanes:	0	0	0
Avoiding Object/Veh in Road:	0	0	0
Weaving:	0	0	0
Wrong Way:	0	0	0
Other:	0	0	0
Unknown:	0	0	0
Total:	5	5	0

Contributing Factor	Veh 1	Veh 2	Veh 3
No Apparent Contributing Factor:	2	4	0
Asleep at the Wheel:	0	0	0
Illness:	0	0	0
Distracted by Passenger:	0	0	0
Driver Inexperience:	0	0	0
Driver Fatigue:	0	0	0
Driver Preoccupied:	1	1	0
Driver Unfamiliar with Area:	0	0	0
Driver Emotionally Upset:	0	0	0
Evading Law Enforcement Officer:	0	0	0
Physical Disability:	0	0	0
Unknown:	2	0	0
Total:	5	5	0

Direction	Veh 1	Veh 2	Veh 3
North:	1	1	0
Northeast:	0	0	0
East:	0	0	0
Southeast:	0	0	0
South:	4	4	0
Southwest:	0	0	0
West:	0	0	0
Northwest:	0	0	0
Unknown:	0	0	0
Total:	5	5	0

Condition of Driver	Veh 1	Veh 2	Veh 3
No Impairment Suspected:	4	5	0
Alcohol Involved:	1	0	0
RX, Medication, or Drugs Involved:	0	0	0
Illegal Drugs Involved:	0	0	0
Alcohol and Drugs Involved:	0	0	0
Driver/Pedestrian not Observed:	0	0	0
Unknown:	0	0	0
Total:	5	5	0

ADT: 9,333 Length: 0.19



Colorado Department of Transportation
DiExSys™ Roadway Safety Systems
Detailed Summary of Crashes Report

10/14/2020

Job #: 20201014102056

Location: 83A Begin: 28.03 End: 28.23 From:01/01/2014 To:12/31/2019

Severity	
PDO:	14
INJ:	29 59 :Injured
FAT:	0 0 :Killed
Total:	43

Number of Vehicles	
One Vehicle:	3
Two Vehicles:	37
Three or More:	3
Unknown:	0
Total:	43

Location	
On Road:	41
Off Road Left:	0
Off Road Right:	2
Off Road at Tee:	0
Off in Median:	0
Unknown:	0
Total:	43

Lighting Conditions	
Daylight:	33
Dawn or Dusk:	2
Dark - Lighted:	7
Dark - Unlighted:	1
Unknown:	0
Total:	43

Weather Conditions	
None:	41
Rain:	1
Snow/Sleet/Hail:	0
Fog:	1
Dust:	0
Wind:	0
Unknown:	0
Total:	43

Crash Rates	
PDO:	5.80 * * MVMT
INJ:	12.02 * ** 100 MVMT
FAT:	0.00 **
Total:	17.82 *

Crash Type			
Overtuning:	1	Bridge Abutment:	0
Other Non Collision:	0	Column/Pier:	0
Pedestrians:	0	Culvert/Headwall:	0
Broadside:	24	Embankment:	1
Head On:	0	Curb:	1
Rear End:	5	Delineator Post:	0
Sideswipe (Same):	1	Fence:	0
Sideswipe (Opposite):	0	Tree:	0
Approach Turn:	10	Large Boulders or Rocks:	0
Overtaking Turn:	0	Barricade:	0
Parked Motor Vehicle:	0	Wall/Building:	0
Railway Vehicle:	0	Crash Cushion:	0
Bicycle:	0	Mailbox:	0
Motorized Bicycle:	0	Other Fixed Object:	0
Domestic Animal:	0	Total Fixed Objects:	2
Wild Animal:	0	Rocks in Roadway:	0
Light/Utility Pole:	0	Vehicle Cargo/Debris:	0
Traffic Signal Pole:	0	Road Maintenance Equipment:	0
Sign:	0	Involving Other Object:	0
Bridge Rail:	0	Total Other Objects:	0
Guard Rail:	0	Unknown:	0
Cable Rail:	0	Total:	43
Concrete Barrier:	0		

Mainline/Ramps/Frontage Roads		Frontage/Ramp Intersections			
Mainline:	43	M:	0	N:	0
Crossroad (A):	0	O:	0	P:	0
Ramps		Total: 43			
B:	0	F:	0	J:	0
C:	0	G:	0	K:	0
D:	0	H:	0	T:	0
E:	0	I:	0	Z:	0
		Left Frontage Rd (L):	0		
		Rt Frontage Rd (R):	0		
		HOV Lanes (V):	0		
		Unknown:	0		

Road Description	
At Intersection:	38
At Driveway Access:	0
Intersection Related:	5
Non Intersection:	0
In Alley:	0
Roundabout:	0
Ramp:	0
Parking Lot:	0
Unknown:	0
Total:	43

Road Conditions	
Dry:	37
Wet:	3
Muddy:	0
Snowy:	0
Icy:	1
Slushy:	0
Foreign Material:	1
With Road Treatment:	0
Dry w/Icy Road Treatment:	0
Wet w/Icy Road Treatment:	1
Snowy w/Icy Road Treatment:	0
Icy w/Icy Road Treatment:	0
Slushy w/Icy Road Treatment:	0
Unknown:	0
Total:	43

ADT: 7,649 Length: 0.14



Colorado Department of Transportation
DiExSys™ Roadway Safety Systems
Detailed Summary of Crashes Report

10/14/2020

Job #: 20201014102056

Location: 83A Begin: 28.03 End: 28.23 From:01/01/2014 To:12/31/2019

Vehicle Type	Veh 1	Veh 2	Veh 3
Passenger Car/Van:	15	16	0
Passenger Car/Van w/Trl:	0	1	0
Pickup Truck/Utility Van:	7	6	0
Pickup Truck/Utility Van w/Trl:	2	0	0
SUV:	18	13	3
SUV w/Trl:	0	0	0
Truck 10k lbs or Less:	0	0	0
Trucks > 10k lbs/Bus > 15 People:	0	2	0
School Bus < 15 People:	0	0	0
Non School Bus < 15 People:	0	0	0
Motorhome:	0	0	0
Motorcycle:	1	2	0
Bicycle:	0	0	0
Motorized Bicycle:	0	0	0
Farm Equipment:	0	0	0
Hit and Run - Unknown:	0	0	0
Other:	0	0	0
Unknown:	0	0	0
Total:	43	40	3

Vehicle Movement	Veh 1	Veh 2	Veh 3
Going Straight:	18	30	1
Slowing:	1	4	0
Stopped in Traffic:	0	3	2
Making Right Turn:	2	0	0
Making Left Turn:	19	2	0
Making U-Turn:	0	0	0
Passing:	1	0	0
Backing:	1	0	0
Enter/Leave Parked Position:	0	0	0
Starting in Traffic:	0	0	0
Parked:	0	0	0
Changing Lanes:	0	0	0
Avoiding Object/Veh in Road:	0	1	0
Weaving:	1	0	0
Wrong Way:	0	0	0
Other:	0	0	0
Unknown:	0	0	0
Total:	43	40	3

Contributing Factor	Veh 1	Veh 2	Veh 3
No Apparent Contributing Factor:	13	33	3
Asleep at the Wheel:	0	0	0
Illness:	0	0	0
Distracted by Passenger:	1	0	0
Driver Inexperience:	10	1	0
Driver Fatigue:	0	0	0
Driver Preoccupied:	7	0	0
Driver Unfamiliar with Area:	2	0	0
Driver Emotionally Upset:	0	0	0
Evading Law Enforcement Officer:	0	0	0
Physical Disability:	0	0	0
Unknown:	10	6	0
Total:	43	40	3

Direction	Veh 1	Veh 2	Veh 3
North:	13	12	1
Northeast:	0	0	0
East:	17	2	1
Southeast:	1	1	0
South:	5	22	0
Southwest:	0	0	0
West:	7	3	1
Northwest:	0	0	0
Unknown:	0	0	0
Total:	43	40	3

Condition of Driver	Veh 1	Veh 2	Veh 3
No Impairment Suspected:	42	39	3
Alcohol Involved:	0	1	0
RX, Medication, or Drugs Involved:	1	0	0
Illegal Drugs Involved:	0	0	0
Alcohol and Drugs Involved:	0	0	0
Driver/Pedestrian not Observed:	0	0	0
Unknown:	0	0	0
Total:	43	40	3

ADT: 7,649 Length: 0.14



Colorado Department of Transportation
DiExSys™ Roadway Safety Systems
Detailed Summary of Crashes Report

10/14/2020

Job #: 20201014102811

Location: 83A Begin: 30.14 End: 30.34 From:01/01/2014 To:12/31/2019

Severity	
PDO:	6
INJ:	8 13 :Injured
FAT:	0 0 :Killed
Total:	14

Number of Vehicles	
One Vehicle:	0
Two Vehicles:	13
Three or More:	1
Unknown:	0
Total:	14

Location	
On Road:	14
Off Road Left:	0
Off Road Right:	0
Off Road at Tee:	0
Off in Median:	0
Unknown:	0
Total:	14

Lighting Conditions	
Daylight:	11
Dawn or Dusk:	0
Dark - Lighted:	1
Dark - Unlighted:	2
Unknown:	0
Total:	14

Weather Conditions	
None:	14
Rain:	0
Snow/Sleet/Hail:	0
Fog:	0
Dust:	0
Wind:	0
Unknown:	0
Total:	14

Crash Rates	
PDO:	3.22 * * MVMT
INJ:	4.30 * ** 100 MVMT
FAT:	0.00 **
Total:	7.52 *

Crash Type			
Overtuning:	0	Bridge Abutment:	0
Other Non Collision:	0	Column/Pier:	0
Pedestrians:	0	Culvert/Headwall:	0
Broadside:	9	Embankment:	0
Head On:	0	Curb:	0
Rear End:	2	Delineator Post:	0
Sideswipe (Same):	0	Fence:	0
Sideswipe (Opposite):	0	Tree:	0
Approach Turn:	3	Large Boulders or Rocks:	0
Overtaking Turn:	0	Barricade:	0
Parked Motor Vehicle:	0	Wall/Building:	0
Railway Vehicle:	0	Crash Cushion:	0
Bicycle:	0	Mailbox:	0
Motorized Bicycle:	0	Other Fixed Object:	0
Domestic Animal:	0	Total Fixed Objects:	0
Wild Animal:	0	Rocks in Roadway:	0
Light/Utility Pole:	0	Vehicle Cargo/Debris:	0
Traffic Signal Pole:	0	Road Maintenance Equipment:	0
Sign:	0	Involving Other Object:	0
Bridge Rail:	0	Total Other Objects:	0
Guard Rail:	0	Unknown:	0
Cable Rail:	0	Total:	14
Concrete Barrier:	0		

Mainline/Ramps/Frontage Roads		Frontage/Ramp Intersections			
Mainline:	14	M:	0	N:	0
Crossroad (A):	0	O:	0	P:	0
Ramps		Total: 14			
B:	0	F:	0	J:	0
C:	0	G:	0	K:	0
D:	0	H:	0	T:	0
E:	0	I:	0	Z:	0
		Left Frontage Rd (L):	0		
		Rt Frontage Rd (R):	0		
		HOV Lanes (V):	0		
		Unknown:	0		

Road Description	
At Intersection:	13
At Driveway Access:	0
Intersection Related:	1
Non Intersection:	0
In Alley:	0
Roundabout:	0
Ramp:	0
Parking Lot:	0
Unknown:	0
Total:	14

Road Conditions	
Dry:	13
Wet:	1
Muddy:	0
Snowy:	0
Icy:	0
Slushy:	0
Foreign Material:	0
With Road Treatment:	0
Dry w/Icy Road Treatment:	0
Wet w/Icy Road Treatment:	0
Snowy w/Icy Road Treatment:	0
Icy w/Icy Road Treatment:	0
Slushy w/Icy Road Treatment:	0
Unknown:	0
Total:	14

ADT: 5,147 Length: 0.16



Colorado Department of Transportation
DiExSys™ Roadway Safety Systems
Detailed Summary of Crashes Report

10/14/2020

Job #: 20201014102811

Location: 83A Begin: 30.14 End: 30.34 From:01/01/2014 To:12/31/2019

Vehicle Type	Veh 1	Veh 2	Veh 3
Passenger Car/Van:	8	3	0
Passenger Car/Van w/Trl:	0	0	0
Pickup Truck/Utility Van:	3	3	0
Pickup Truck/Utility Van w/Trl:	0	0	0
SUV:	3	7	0
SUV w/Trl:	0	0	0
Truck 10k lbs or Less:	0	0	0
Trucks > 10k lbs/Bus > 15 People:	0	1	0
School Bus < 15 People:	0	0	0
Non School Bus < 15 People:	0	0	0
Motorhome:	0	0	0
Motorcycle:	0	0	0
Bicycle:	0	0	1
Motorized Bicycle:	0	0	0
Farm Equipment:	0	0	0
Hit and Run - Unknown:	0	0	0
Other:	0	0	0
Unknown:	0	0	0
Total:	14	14	1

Vehicle Movement	Veh 1	Veh 2	Veh 3
Going Straight:	7	9	0
Slowing:	0	1	0
Stopped in Traffic:	0	3	0
Making Right Turn:	2	1	0
Making Left Turn:	3	0	0
Making U-Turn:	0	0	0
Passing:	0	0	0
Backing:	0	0	0
Enter/Leave Parked Position:	1	0	0
Starting in Traffic:	0	0	0
Parked:	0	0	0
Changing Lanes:	0	0	0
Avoiding Object/Veh in Road:	0	0	0
Weaving:	0	0	0
Wrong Way:	0	0	0
Other:	1	0	1
Unknown:	0	0	0
Total:	14	14	1

Contributing Factor	Veh 1	Veh 2	Veh 3
No Apparent Contributing Factor:	1	14	1
Asleep at the Wheel:	0	0	0
Illness:	0	0	0
Distracted by Passenger:	0	0	0
Driver Inexperience:	4	0	0
Driver Fatigue:	0	0	0
Driver Preoccupied:	3	0	0
Driver Unfamiliar with Area:	1	0	0
Driver Emotionally Upset:	0	0	0
Evading Law Enforcement Officer:	0	0	0
Physical Disability:	0	0	0
Unknown:	5	0	0
Total:	14	14	1

Direction	Veh 1	Veh 2	Veh 3
North:	6	5	0
Northeast:	0	0	0
East:	6	1	0
Southeast:	0	0	0
South:	0	6	0
Southwest:	0	0	0
West:	2	2	1
Northwest:	0	0	0
Unknown:	0	0	0
Total:	14	14	1

Condition of Driver	Veh 1	Veh 2	Veh 3
No Impairment Suspected:	13	14	1
Alcohol Involved:	1	0	0
RX, Medication, or Drugs Involved:	0	0	0
Illegal Drugs Involved:	0	0	0
Alcohol and Drugs Involved:	0	0	0
Driver/Pedestrian not Observed:	0	0	0
Unknown:	0	0	0
Total:	14	14	1

ADT: 5,147 Length: 0.16

This page intentionally left blank.

Appendix D. Results of Analysis

D.1. Existing (2020)

HCM Signalized Intersection Capacity Analysis

1: CO 83 & SO 21 SB

09/17/2021



Movement	NWL	NWR	NET	NER	SWL	SWT
Lane Configurations			↑↑	↑	↑	↑↑
Traffic Volume (vph)	0	0	203	708	598	1352
Future Volume (vph)	0	0	203	708	598	1352
Ideal Flow (vphpl)	1900	1900	1900	1900	1900	1900
Total Lost time (s)			7.5	4.0	5.0	7.5
Lane Util. Factor			0.95	1.00	1.00	0.95
Frt			1.00	0.85	1.00	1.00
Flt Protected			1.00	1.00	0.95	1.00
Satd. Flow (prot)			3195	1429	1597	3195
Flt Permitted			1.00	1.00	0.56	1.00
Satd. Flow (perm)			3195	1429	949	3195
Peak-hour factor, PHF	0.92	0.92	0.86	0.86	0.91	0.91
Adj. Flow (vph)	0	0	236	823	657	1486
RTOR Reduction (vph)	0	0	0	0	0	0
Lane Group Flow (vph)	0	0	236	823	657	1486
Turn Type			NA	Free	pm+pt	NA
Protected Phases			2		1	6
Permitted Phases				Free	6	
Actuated Green, G (s)			70.0	88.2	80.7	88.2
Effective Green, g (s)			70.0	88.2	80.7	88.2
Actuated g/C Ratio			0.79	1.00	0.91	1.00
Clearance Time (s)			7.5		5.0	7.5
Vehicle Extension (s)			1.0		3.0	1.0
Lane Grp Cap (vph)			2535	1429	910	3195
v/s Ratio Prot			0.07		0.05	0.47
v/s Ratio Perm				c0.58	c0.61	
v/c Ratio			0.09	0.58	0.72	0.47
Uniform Delay, d1			2.0	0.0	0.9	0.0
Progression Factor			1.00	1.00	1.00	1.00
Incremental Delay, d2			0.1	1.7	2.9	0.5
Delay (s)			2.1	1.7	3.8	0.5
Level of Service			A	A	A	A
Approach Delay (s)	0.0		1.8			1.5
Approach LOS	A		A			A

Intersection Summary

HCM 2000 Control Delay	1.6	HCM 2000 Level of Service	A
HCM 2000 Volume to Capacity ratio	0.77		
Actuated Cycle Length (s)	88.2	Sum of lost time (s)	12.5
Intersection Capacity Utilization	65.2%	ICU Level of Service	C
Analysis Period (min)	15		

c Critical Lane Group

HCM Signalized Intersection Capacity Analysis

2: CO 83 & CO 21 NB

09/17/2021



Movement	NWL	NWR	NET	NER	SWL	SWT
Lane Configurations						
Traffic Volume (vph)	934	572	203	0	0	1002
Future Volume (vph)	934	572	203	0	0	1002
Ideal Flow (vphpl)	1900	1900	1900	1900	1900	1900
Total Lost time (s)	6.5	4.0	7.5			6.5
Lane Util. Factor	0.97	1.00	0.95			0.95
Frt	1.00	0.85	1.00			1.00
Flt Protected	0.95	1.00	1.00			1.00
Satd. Flow (prot)	3099	1429	3195			3195
Flt Permitted	0.95	1.00	1.00			1.00
Satd. Flow (perm)	3099	1429	3195			3195
Peak-hour factor, PHF	0.88	0.88	0.69	0.69	0.90	0.90
Adj. Flow (vph)	1061	650	294	0	0	1113
RTOR Reduction (vph)	0	0	0	0	0	0
Lane Group Flow (vph)	1061	650	294	0	0	1113
Turn Type	Prot	Free	NA			NA
Protected Phases	4		2			6
Permitted Phases		Free				
Actuated Green, G (s)	38.3	102.5	50.2			51.2
Effective Green, g (s)	38.3	102.5	50.2			51.2
Actuated g/C Ratio	0.37	1.00	0.49			0.50
Clearance Time (s)	6.5		7.5			6.5
Vehicle Extension (s)	2.0		1.0			1.0
Lane Grp Cap (vph)	1157	1429	1564			1595
v/s Ratio Prot	c0.34		0.09			c0.35
v/s Ratio Perm		0.45				
v/c Ratio	0.92	0.45	0.19			0.70
Uniform Delay, d1	30.6	0.0	14.7			19.7
Progression Factor	1.00	1.00	1.00			1.00
Incremental Delay, d2	11.1	1.0	0.3			2.6
Delay (s)	41.7	1.0	15.0			22.3
Level of Service	D	A	B			C
Approach Delay (s)	26.3		15.0			22.3
Approach LOS	C		B			C

Intersection Summary



















HCM 2000 Control Delay	23.8	HCM 2000 Level of Service	C
HCM 2000 Volume to Capacity ratio	0.80		
Actuated Cycle Length (s)	102.5	Sum of lost time (s)	14.0
Intersection Capacity Utilization	65.2%	ICU Level of Service	C
Analysis Period (min)	15		

c Critical Lane Group

HCM Unsignalized Intersection Capacity Analysis

3: CO 83 & CDOT Yard

09/17/2021

												
Movement	EBL	EBT	EBR	WBL	WBT	WBR	NBL	NBT	NBR	SBL	SBT	SBR
Lane Configurations												
Traffic Volume (veh/h)	0	0	1	0	0	1	2	729	2	0	1007	1
Future Volume (Veh/h)	0	0	1	0	0	1	2	729	2	0	1007	1
Sign Control		Stop			Stop			Free			Free	
Grade		0%			0%			0%			0%	
Peak Hour Factor	0.50	0.50	0.50	0.25	0.25	0.25	0.92	0.92	0.92	0.91	0.91	0.91
Hourly flow rate (vph)	0	0	2	0	0	4	2	792	2	0	1107	1
Pedestrians												
Lane Width (ft)												
Walking Speed (ft/s)												
Percent Blockage												
Right turn flare (veh)												
Median type								None			None	
Median storage (veh)												
Upstream signal (ft)								681				
pX, platoon unblocked	0.98	0.98		0.98	0.98	0.98				0.98		
vC, conflicting volume	1511	1905	554	1352	1905	397	1108			794		
vC1, stage 1 conf vol												
vC2, stage 2 conf vol												
vCu, unblocked vol	1479	1882	554	1317	1882	341	1108			747		
tC, single (s)	7.5	6.5	6.9	7.8	6.8	7.2	4.4			4.4		
tC, 2 stage (s)												
tF (s)	3.5	4.0	3.3	3.6	4.1	3.4	2.3			2.3		
p0 queue free %	100	100	100	100	100	99	100			100		
cM capacity (veh/h)	86	70	481	102	61	610	566			772		
Direction, Lane #	EB 1	WB 1	NB 1	NB 2	NB 3	SB 1	SB 2	SB 3	SB 4			
Volume Total	2	4	2	528	266	0	554	554	1			
Volume Left	0	0	2	0	0	0	0	0	0			
Volume Right	2	4	0	0	2	0	0	0	1			
cSH	481	610	566	1700	1700	1700	1700	1700	1700			
Volume to Capacity	0.00	0.01	0.00	0.31	0.16	0.00	0.33	0.33	0.00			
Queue Length 95th (ft)	0	0	0	0	0	0	0	0	0			
Control Delay (s)	12.5	10.9	11.4	0.0	0.0	0.0	0.0	0.0	0.0			
Lane LOS	B	B	B									
Approach Delay (s)	12.5	10.9	0.0			0.0						
Approach LOS	B	B										
Intersection Summary												
Average Delay			0.0									
Intersection Capacity Utilization			37.8%		ICU Level of Service					A		
Analysis Period (min)			15									

HCM Signalized Intersection Capacity Analysis

4: CO 83 & Shoup Road

09/17/2021



Movement	NBT	NBR	SBL	SBT	SWL	SWR
Lane Configurations	↑↑	↑↗	↘	↑↑	↘	↗
Traffic Volume (vph)	641	133	32	783	193	180
Future Volume (vph)	641	133	32	783	193	180
Ideal Flow (vphpl)	1900	1900	1900	1900	1900	1900
Total Lost time (s)	7.5	4.0	5.0	7.5	6.0	4.0
Lane Util. Factor	0.95	1.00	1.00	0.95	1.00	1.00
Frt	1.00	0.85	1.00	1.00	1.00	0.85
Flt Protected	1.00	1.00	0.95	1.00	0.95	1.00
Satd. Flow (prot)	3195	1429	1597	3195	1597	1429
Flt Permitted	1.00	1.00	0.31	1.00	0.95	1.00
Satd. Flow (perm)	3195	1429	526	3195	1597	1429
Peak-hour factor, PHF	0.87	0.87	0.86	0.86	0.82	0.82
Adj. Flow (vph)	737	153	37	910	235	220
RTOR Reduction (vph)	0	0	0	0	0	0
Lane Group Flow (vph)	737	153	37	910	235	220
Turn Type	NA	Free	pm+pt	NA	Prot	Free
Protected Phases	2		1	6	8	
Permitted Phases		Free	6			Free
Actuated Green, G (s)	45.7	84.0	53.3	53.3	17.2	84.0
Effective Green, g (s)	45.7	84.0	53.3	53.3	17.2	84.0
Actuated g/C Ratio	0.54	1.00	0.63	0.63	0.20	1.00
Clearance Time (s)	7.5		5.0	7.5	6.0	
Vehicle Extension (s)	1.0		1.0	1.0	3.0	
Lane Grp Cap (vph)	1738	1429	366	2027	327	1429
v/s Ratio Prot	0.23		0.00	c0.28	c0.15	
v/s Ratio Perm		0.11	0.06			0.15
v/c Ratio	0.42	0.11	0.10	0.45	0.72	0.15
Uniform Delay, d1	11.3	0.0	6.2	7.8	31.1	0.0
Progression Factor	1.00	1.00	1.00	1.00	1.00	1.00
Incremental Delay, d2	0.8	0.2	0.0	0.7	7.4	0.2
Delay (s)	12.1	0.2	6.2	8.6	38.5	0.2
Level of Service	B	A	A	A	D	A
Approach Delay (s)	10.1			8.5	20.0	
Approach LOS	B			A	B	

Intersection Summary

HCM 2000 Control Delay	11.4	HCM 2000 Level of Service	B
HCM 2000 Volume to Capacity ratio	0.55		
Actuated Cycle Length (s)	84.0	Sum of lost time (s)	18.5
Intersection Capacity Utilization	47.2%	ICU Level of Service	A
Analysis Period (min)	15		

c Critical Lane Group

HCM Signalized Intersection Capacity Analysis

5: CO 83 & Flying Horse Club Dr/Abert Way

09/17/2021



Movement	EBL	EBT	EBR	WBL	WBT	WBR	NBL	NBT	NBR	SBL	SBT	SBR
Lane Configurations												
Traffic Volume (vph)	8	0	109	1	0	6	78	747	0	1	762	9
Future Volume (vph)	8	0	109	1	0	6	78	747	0	1	762	9
Ideal Flow (vphpl)	1900	1900	1900	1900	1900	1900	1900	1900	1900	1900	1900	1900
Total Lost time (s)	7.0		7.0	7.0	7.0		7.0	8.0		7.0	8.0	8.0
Lane Util. Factor	1.00		1.00	1.00	1.00		1.00	0.95		1.00	0.95	1.00
Frpb, ped/bikes	1.00		1.00	1.00	1.00		1.00	1.00		1.00	1.00	1.00
Flpb, ped/bikes	1.00		1.00	1.00	1.00		1.00	1.00		1.00	1.00	1.00
Frt	1.00		0.85	1.00	0.85		1.00	1.00		1.00	1.00	0.85
Flt Protected	0.95		1.00	0.95	1.00		0.95	1.00		0.95	1.00	1.00
Satd. Flow (prot)	1597		1429	1597	1429		1597	3195		1596	3195	1429
Flt Permitted	0.75		1.00	0.76	1.00		0.24	1.00		0.34	1.00	1.00
Satd. Flow (perm)	1258		1429	1273	1429		406	3195		570	3195	1429
Peak-hour factor, PHF	0.75	0.75	0.75	0.44	0.44	0.44	0.90	0.90	0.90	0.83	0.83	0.83
Adj. Flow (vph)	11	0	145	2	0	14	87	830	0	1	918	11
RTOR Reduction (vph)	0	0	131	0	13	0	0	0	0	0	0	5
Lane Group Flow (vph)	11	0	14	2	1	0	87	830	0	1	918	6
Confl. Peds. (#/hr)									6	6		
Turn Type	Perm		Perm	Perm	NA		pm+pt	NA	Perm	pm+pt	NA	Perm
Protected Phases		4			8		5	2		1	6	
Permitted Phases	4		4	8			2		2	6		6
Actuated Green, G (s)	7.2		7.2	7.2	7.2		50.5	44.4		40.5	39.4	39.4
Effective Green, g (s)	7.2		7.2	7.2	7.2		50.5	44.4		40.5	39.4	39.4
Actuated g/C Ratio	0.10		0.10	0.10	0.10		0.68	0.59		0.54	0.53	0.53
Clearance Time (s)	7.0		7.0	7.0	7.0		7.0	8.0		7.0	8.0	8.0
Vehicle Extension (s)	3.0		3.0	3.0	3.0		3.0	3.0		3.0	3.0	3.0
Lane Grp Cap (vph)	121		137	122	137		371	1899		324	1685	753
v/s Ratio Prot					0.00		c0.02	c0.26		0.00	c0.29	
v/s Ratio Perm	0.01		c0.01	0.00			0.14			0.00		0.00
v/c Ratio	0.09		0.10	0.02	0.01		0.23	0.44		0.00	0.54	0.01
Uniform Delay, d1	30.8		30.8	30.5	30.5		4.9	8.3		7.8	11.7	8.4
Progression Factor	1.00		1.00	1.00	1.00		1.00	1.00		1.00	1.00	1.00
Incremental Delay, d2	0.3		0.3	0.1	0.0		0.3	0.2		0.0	0.4	0.0
Delay (s)	31.1		31.1	30.6	30.6		5.3	8.5		7.8	12.1	8.4
Level of Service	C		C	C	C		A	A		A	B	A
Approach Delay (s)		31.1			30.6			8.2			12.0	
Approach LOS		C			C			A			B	

Intersection Summary

HCM 2000 Control Delay	11.9	HCM 2000 Level of Service	B
HCM 2000 Volume to Capacity ratio	0.47		
Actuated Cycle Length (s)	74.7	Sum of lost time (s)	22.0
Intersection Capacity Utilization	60.1%	ICU Level of Service	B
Analysis Period (min)	15		
c Critical Lane Group			

HCM Signalized Intersection Capacity Analysis

6: CO 83 & North Gate Blvd

09/17/2021



Movement	EBL	EBT	EBR	WBL	WBT	WBR	NBL	NBT	NBR	SBL	SBT	SBR
Lane Configurations												
Traffic Volume (vph)	51	0	278	1	0	0	471	300	1	2	507	99
Future Volume (vph)	51	0	278	1	0	0	471	300	1	2	507	99
Ideal Flow (vphpl)	1900	1900	1900	1900	1900	1900	1900	1900	1900	1900	1900	1900
Total Lost time (s)	6.0		6.0		6.0		5.0	7.0		7.0	7.0	7.0
Lane Util. Factor	1.00		1.00		1.00		1.00	0.95		1.00	0.95	1.00
Frpb, ped/bikes	1.00		1.00		1.00		1.00	1.00		1.00	1.00	1.00
Flpb, ped/bikes	1.00		1.00		1.00		1.00	1.00		1.00	1.00	1.00
Frt	1.00		0.85		1.00		1.00	1.00		1.00	1.00	0.85
Flt Protected	0.95		1.00		0.95		0.95	1.00		0.95	1.00	1.00
Satd. Flow (prot)	1438		1286		1438		1438	2874		1434	2875	1286
Flt Permitted	0.76		1.00		0.76		0.38	1.00		0.54	1.00	1.00
Satd. Flow (perm)	1143		1286		1146		572	2874		821	2875	1286
Peak-hour factor, PHF	0.84	0.84	0.84	0.25	0.25	0.25	0.87	0.87	0.87	0.89	0.89	0.89
Adj. Flow (vph)	61	0	331	4	0	0	541	345	1	2	570	111
RTOR Reduction (vph)	0	0	298	0	0	0	0	0	0	0	0	53
Lane Group Flow (vph)	61	0	33	0	4	0	541	346	0	2	570	58
Confl. Peds. (#/hr)									3	3		
Turn Type	Perm		Perm	Perm	NA		pm+pt	NA		Perm	NA	Perm
Protected Phases		4			8		5	2			6	
Permitted Phases	4		4	8			2			6		6
Actuated Green, G (s)	11.4		11.4		11.4		90.1	90.1		60.1	60.1	60.1
Effective Green, g (s)	11.4		11.4		11.4		90.1	90.1		60.1	60.1	60.1
Actuated g/C Ratio	0.10		0.10		0.10		0.79	0.79		0.52	0.52	0.52
Clearance Time (s)	6.0		6.0		6.0		5.0	7.0		7.0	7.0	7.0
Vehicle Extension (s)	3.0		3.0		3.0		3.0	3.0		3.0	3.0	3.0
Lane Grp Cap (vph)	113		128		114		639	2261		430	1509	675
v/s Ratio Prot							c0.18	0.12			0.20	
v/s Ratio Perm	c0.05		0.03		0.00		c0.48			0.00		0.05
v/c Ratio	0.54		0.26		0.04		0.85	0.15		0.00	0.38	0.09
Uniform Delay, d1	49.1		47.6		46.6		6.0	3.0		13.0	16.1	13.5
Progression Factor	1.00		1.00		1.00		1.00	1.00		1.00	1.00	1.00
Incremental Delay, d2	4.9		1.1		0.1		10.1	0.1		0.0	0.7	0.3
Delay (s)	53.9		48.7		46.7		16.1	3.1		13.0	16.8	13.8
Level of Service	D		D		D		B	A		B	B	B
Approach Delay (s)		49.5			46.7			11.1			16.3	
Approach LOS		D			D			B			B	
Intersection Summary												
HCM 2000 Control Delay			20.6				HCM 2000 Level of Service			C		
HCM 2000 Volume to Capacity ratio			0.84									
Actuated Cycle Length (s)			114.5			Sum of lost time (s)			18.0			
Intersection Capacity Utilization			68.2%			ICU Level of Service			C			
Analysis Period (min)			15									
c Critical Lane Group												

HCM Unsignalized Intersection Capacity Analysis

7: CO 83

09/17/2021



Movement	WBL	WBR	NBT	NBR	SBL	SBT
Lane Configurations						
Traffic Volume (veh/h)	1	2	342	5	1	601
Future Volume (Veh/h)	1	2	342	5	1	601
Sign Control	Stop		Free		Free	
Grade	0%		0%		0%	
Peak Hour Factor	0.75	0.75	0.86	0.86	0.92	0.92
Hourly flow rate (vph)	1	3	398	6	1	653
Pedestrians						
Lane Width (ft)						
Walking Speed (ft/s)						
Percent Blockage						
Right turn flare (veh)						
Median type	None			None		
Median storage (veh)						
Upstream signal (ft)						
pX, platoon unblocked						
vC, conflicting volume	730	401			404	
vC1, stage 1 conf vol						
vC2, stage 2 conf vol						
vCu, unblocked vol	730	401			404	
tC, single (s)	7.1	7.2			4.4	
tC, 2 stage (s)						
tF (s)	3.6	3.4			2.3	
p0 queue free %	100	99			100	
cM capacity (veh/h)	335	569			1076	
Direction, Lane #	WB 1	NB 1	SB 1	SB 2	SB 3	
Volume Total	4	404	1	326	326	
Volume Left	1	0	1	0	0	
Volume Right	3	6	0	0	0	
cSH	484	1700	1076	1700	1700	
Volume to Capacity	0.01	0.24	0.00	0.19	0.19	
Queue Length 95th (ft)	1	0	0	0	0	
Control Delay (s)	12.5	0.0	8.3	0.0	0.0	
Lane LOS	B		A			
Approach Delay (s)	12.5	0.0	0.0			
Approach LOS	B					
Intersection Summary						
Average Delay			0.1			
Intersection Capacity Utilization			28.3%	ICU Level of Service	A	
Analysis Period (min)			15			

HCM Unsignalized Intersection Capacity Analysis

8: CO 83 & Old North Gate Rd

09/17/2021



Movement	EBL	EBR	NBL	NBT	SBT	SBR
Lane Configurations						
Traffic Volume (veh/h)	6	131	55	290	471	21
Future Volume (Veh/h)	6	131	55	290	471	21
Sign Control	Stop			Free	Free	
Grade	0%			0%	0%	
Peak Hour Factor	0.76	0.76	0.87	0.87	0.91	0.91
Hourly flow rate (vph)	8	172	63	333	518	23
Pedestrians						
Lane Width (ft)						
Walking Speed (ft/s)						
Percent Blockage						
Right turn flare (veh)	2					
Median type				None	None	
Median storage (veh)						
Upstream signal (ft)						
pX, platoon unblocked						
vC, conflicting volume	988	530	541			
vC1, stage 1 conf vol						
vC2, stage 2 conf vol						
vCu, unblocked vol	988	530	541			
tC, single (s)	6.5	6.3	4.2			
tC, 2 stage (s)						
tF (s)	3.6	3.4	2.3			
p0 queue free %	97	67	94			
cM capacity (veh/h)	244	528	974			
Direction, Lane #	EB 1	NB 1	NB 2	SB 1		
Volume Total	180	63	333	541		
Volume Left	8	63	0	0		
Volume Right	172	0	0	23		
cSH	553	974	1700	1700		
Volume to Capacity	0.33	0.06	0.20	0.32		
Queue Length 95th (ft)	35	5	0	0		
Control Delay (s)	15.3	8.9	0.0	0.0		
Lane LOS	C	A				
Approach Delay (s)	15.3	1.4		0.0		
Approach LOS	C					
Intersection Summary						
Average Delay	3.0					
Intersection Capacity Utilization	42.7%			ICU Level of Service	A	
Analysis Period (min)	15					

HCM Unsignalized Intersection Capacity Analysis

9: CO 83 & Old Lasso Point

09/17/2021



Movement	EBL	EBR	NBL	NBT	SBT	SBR
Lane Configurations						
Traffic Volume (veh/h)	0	2	1	296	492	0
Future Volume (Veh/h)	0	2	1	296	492	0
Sign Control	Stop			Free	Free	
Grade	0%			0%	0%	
Peak Hour Factor	0.50	0.50	0.83	0.83	0.90	0.90
Hourly flow rate (vph)	0	4	1	357	547	0
Pedestrians						
Lane Width (ft)						
Walking Speed (ft/s)						
Percent Blockage						
Right turn flare (veh)						
Median type				None	None	
Median storage (veh)						
Upstream signal (ft)						
pX, platoon unblocked						
vC, conflicting volume	906	547	547			
vC1, stage 1 conf vol						
vC2, stage 2 conf vol						
vCu, unblocked vol	906	547	547			
tC, single (s)	6.5	6.3	4.2			
tC, 2 stage (s)						
tF (s)	3.6	3.4	2.3			
p0 queue free %	100	99	100			
cM capacity (veh/h)	293	516	969			
Direction, Lane #	EB 1	NB 1	SB 1			
Volume Total	4	358	547			
Volume Left	0	1	0			
Volume Right	4	0	0			
cSH	516	969	1700			
Volume to Capacity	0.01	0.00	0.32			
Queue Length 95th (ft)	1	0	0			
Control Delay (s)	12.0	0.0	0.0			
Lane LOS	B	A				
Approach Delay (s)	12.0	0.0	0.0			
Approach LOS	B					
Intersection Summary						
Average Delay			0.1			
Intersection Capacity Utilization			35.9%	ICU Level of Service	A	
Analysis Period (min)			15			

Intersection has too many legs for HCM analysis.

HCM Unsignalized Intersection Capacity Analysis

11: CO 83 & Kaessner Lane



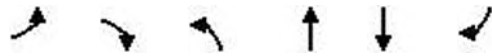

















09/17/2021



Movement	EBL	EBR	NBL	NBT	SBT	SBR
Lane Configurations						
Traffic Volume (veh/h)	0	6	1	285	493	1
Future Volume (Veh/h)	0	6	1	285	493	1
Sign Control	Stop			Free	Free	
Grade	0%			0%	0%	
Peak Hour Factor	0.50	0.50	0.87	0.87	0.92	0.92
Hourly flow rate (vph)	0	12	1	328	536	1
Pedestrians						
Lane Width (ft)						
Walking Speed (ft/s)						
Percent Blockage						
Right turn flare (veh)						
Median type				None	None	
Median storage (veh)						
Upstream signal (ft)						
pX, platoon unblocked						
vC, conflicting volume	866	536	537			
vC1, stage 1 conf vol						
vC2, stage 2 conf vol						
vCu, unblocked vol	866	536	537			
tC, single (s)	6.5	6.3	4.2			
tC, 2 stage (s)						
tF (s)	3.6	3.4	2.3			
p0 queue free %	100	98	100			
cM capacity (veh/h)	309	523	978			
Direction, Lane #	EB 1	NB 1	SB 1			
Volume Total	12	329	537			
Volume Left	0	1	0			
Volume Right	12	0	1			
cSH	523	978	1700			
Volume to Capacity	0.02	0.00	0.32			
Queue Length 95th (ft)	2	0	0			
Control Delay (s)	12.0	0.0	0.0			
Lane LOS	B	A				
Approach Delay (s)	12.0	0.0	0.0			
Approach LOS	B					
Intersection Summary						
Average Delay	0.2					
Intersection Capacity Utilization	36.0%			ICU Level of Service	A	
Analysis Period (min)	15					

HCM Unsignalized Intersection Capacity Analysis
 12: CO 83 & Stagecoach Rd

09/17/2021

												
Movement	EBL	EBT	EBR	WBL	WBT	WBR	NBL	NBT	NBR	SBL	SBT	SBR
Lane Configurations												
Traffic Volume (veh/h)	0	1	5	15	1	7	1	246	30	8	466	0
Future Volume (Veh/h)	0	1	5	15	1	7	1	246	30	8	466	0
Sign Control		Stop			Stop			Free			Free	
Grade		0%			0%			0%			0%	
Peak Hour Factor	0.58	0.58	0.58	0.72	0.72	0.72	0.85	0.85	0.85	0.91	0.91	0.91
Hourly flow rate (vph)	0	2	9	21	1	10	1	289	35	9	512	0
Pedestrians												
Lane Width (ft)												
Walking Speed (ft/s)												
Percent Blockage												
Right turn flare (veh)							6					
Median type							None			None		
Median storage (veh)												
Upstream signal (ft)												
pX, platoon unblocked												
vC, conflicting volume	826	856	512	831	821	289	512				324	
vC1, stage 1 conf vol												
vC2, stage 2 conf vol												
vCu, unblocked vol	826	856	512	831	821	289	512				324	
tC, single (s)	7.2	6.6	6.3	7.2	6.6	6.3	4.2				4.2	
tC, 2 stage (s)												
tF (s)	3.6	4.1	3.4	3.6	4.1	3.4	2.3				2.3	
p0 queue free %	100	99	98	92	100	99	100				99	
cM capacity (veh/h)	272	281	541	269	295	725	999				1176	
Direction, Lane #	EB 1	WB 1	NB 1	NB 2	SB 1	SB 2						
Volume Total	11	32	290	35	9	512						
Volume Left	0	21	1	0	9	0						
Volume Right	9	10	0	35	0	0						
cSH	463	393	999	1700	1176	1700						
Volume to Capacity	0.02	0.08	0.00	0.02	0.01	0.30						
Queue Length 95th (ft)	2	7	0	0	1	0						
Control Delay (s)	13.0	16.6	0.0	0.0	8.1	0.0						
Lane LOS	B	C	A		A							
Approach Delay (s)	13.0	16.6	0.0		0.1							
Approach LOS	B	C										
Intersection Summary												
Average Delay			0.9									
Intersection Capacity Utilization			41.2%		ICU Level of Service			A				
Analysis Period (min)			15									

HCM Unsignalized Intersection Capacity Analysis

13: CO 83 & Private Access

09/17/2021



Movement	EBL	EBR	NBL	NBT	SBT	SBR
Lane Configurations						
Traffic Volume (veh/h)	3	1	0	260	480	0
Future Volume (Veh/h)	3	1	0	260	480	0
Sign Control	Stop			Free	Free	
Grade	0%			0%	0%	
Peak Hour Factor	1.00	1.00	0.87	0.87	0.92	0.92
Hourly flow rate (vph)	3	1	0	299	522	0
Pedestrians						
Lane Width (ft)						
Walking Speed (ft/s)						
Percent Blockage						
Right turn flare (veh)						
Median type				None	None	
Median storage (veh)						
Upstream signal (ft)						
pX, platoon unblocked						
vC, conflicting volume	821	522	522			
vC1, stage 1 conf vol						
vC2, stage 2 conf vol						
vCu, unblocked vol	821	522	522			
tC, single (s)	6.5	6.3	4.2			
tC, 2 stage (s)						
tF (s)	3.6	3.4	2.3			
p0 queue free %	99	100	100			
cM capacity (veh/h)	330	534	991			
Direction, Lane #	EB 1	NB 1	SB 1			
Volume Total	4	299	522			
Volume Left	3	0	0			
Volume Right	1	0	0			
cSH	364	991	1700			
Volume to Capacity	0.01	0.00	0.31			
Queue Length 95th (ft)	1	0	0			
Control Delay (s)	15.0	0.0	0.0			
Lane LOS	B					
Approach Delay (s)	15.0	0.0	0.0			
Approach LOS	B					
Intersection Summary						
Average Delay			0.1			
Intersection Capacity Utilization			35.3%	ICU Level of Service	A	
Analysis Period (min)			15			

HCM Unsignalized Intersection Capacity Analysis

14: CO 83 & Benet Lane











09/17/2021



Movement	EBL	EBR	NBL	NBT	SBT	SBR
Lane Configurations						
Traffic Volume (veh/h)	0	3	4	257	467	0
Future Volume (Veh/h)	0	3	4	257	467	0
Sign Control	Stop			Free	Free	
Grade	0%			0%	0%	
Peak Hour Factor	0.38	0.38	0.86	0.86	0.89	0.89
Hourly flow rate (vph)	0	8	5	299	525	0
Pedestrians						
Lane Width (ft)						
Walking Speed (ft/s)						
Percent Blockage						
Right turn flare (veh)						
Median type				None	None	
Median storage (veh)						
Upstream signal (ft)						
pX, platoon unblocked						
vC, conflicting volume	834	525	525			
vC1, stage 1 conf vol						
vC2, stage 2 conf vol						
vCu, unblocked vol	834	525	525			
tC, single (s)	6.5	6.3	4.2			
tC, 2 stage (s)						
tF (s)	3.6	3.4	2.3			
p0 queue free %	100	98	99			
cM capacity (veh/h)	322	531	988			
Direction, Lane #	EB 1	NB 1	NB 2	SB 1		
Volume Total	8	5	299	525		
Volume Left	0	5	0	0		
Volume Right	8	0	0	0		
cSH	531	988	1700	1700		
Volume to Capacity	0.02	0.01	0.18	0.31		
Queue Length 95th (ft)	1	0	0	0		
Control Delay (s)	11.9	8.7	0.0	0.0		
Lane LOS	B	A				
Approach Delay (s)	11.9	0.1	0.0			
Approach LOS	B					
Intersection Summary						
Average Delay	0.2					
Intersection Capacity Utilization	34.6%			ICU Level of Service	A	
Analysis Period (min)	15					

HCM Unsignalized Intersection Capacity Analysis
 15: CO 83 & High Forest Rd

09/17/2021

						
Movement	WBL	WBR	NBT	NBR	SBL	SBT
Lane Configurations						
Traffic Volume (veh/h)	40	9	229	23	3	429
Future Volume (Veh/h)	40	9	229	23	3	429
Sign Control	Stop		Free		Free	
Grade	0%		0%		0%	
Peak Hour Factor	0.88	0.88	0.85	0.85	0.89	0.89
Hourly flow rate (vph)	45	10	269	27	3	482
Pedestrians						
Lane Width (ft)						
Walking Speed (ft/s)						
Percent Blockage						
Right turn flare (veh)						
Median type	None			None		
Median storage (veh)						
Upstream signal (ft)						
pX, platoon unblocked						
vC, conflicting volume	757	269			296	
vC1, stage 1 conf vol						
vC2, stage 2 conf vol						
vCu, unblocked vol	757	269			296	
tC, single (s)	6.5	6.3			4.2	
tC, 2 stage (s)						
tF (s)	3.6	3.4			2.3	
p0 queue free %	87	99			100	
cM capacity (veh/h)	359	744			1205	
Direction, Lane #	WB 1	NB 1	NB 2	SB 1	SB 2	
Volume Total	55	269	27	3	482	
Volume Left	45	0	0	3	0	
Volume Right	10	0	27	0	0	
cSH	396	1700	1700	1205	1700	
Volume to Capacity	0.14	0.16	0.02	0.00	0.28	
Queue Length 95th (ft)	12	0	0	0	0	
Control Delay (s)	15.5	0.0	0.0	8.0	0.0	
Lane LOS	C			A		
Approach Delay (s)	15.5	0.0		0.0		
Approach LOS	C					
Intersection Summary						
Average Delay			1.1			
Intersection Capacity Utilization			32.6%		ICU Level of Service	A
Analysis Period (min)			15			

HCM Unsignalized Intersection Capacity Analysis
 16: CO 83 & Arena Rd

09/17/2021



Movement	EBL	EBR	NBL	NBT	SBT	SBR
Lane Configurations						
Traffic Volume (veh/h)	0	2	1	241	429	2
Future Volume (Veh/h)	0	2	1	241	429	2
Sign Control	Stop			Free	Free	
Grade	0%			0%	0%	
Peak Hour Factor	0.50	0.50	0.87	0.87	0.89	0.89
Hourly flow rate (vph)	0	4	1	277	482	2
Pedestrians						
Lane Width (ft)						
Walking Speed (ft/s)						
Percent Blockage						
Right turn flare (veh)						
Median type				None	None	
Median storage (veh)						
Upstream signal (ft)						
pX, platoon unblocked						
vC, conflicting volume	762	483	484			
vC1, stage 1 conf vol						
vC2, stage 2 conf vol						
vCu, unblocked vol	762	483	484			
tC, single (s)	6.5	6.3	4.2			
tC, 2 stage (s)						
tF (s)	3.6	3.4	2.3			
p0 queue free %	100	99	100			
cM capacity (veh/h)	357	562	1024			
Direction, Lane #	EB 1	NB 1	SB 1			
Volume Total	4	278	484			
Volume Left	0	1	0			
Volume Right	4	0	2			
cSH	562	1024	1700			
Volume to Capacity	0.01	0.00	0.28			
Queue Length 95th (ft)	1	0	0			
Control Delay (s)	11.5	0.0	0.0			
Lane LOS	B	A				
Approach Delay (s)	11.5	0.0	0.0			
Approach LOS	B					
Intersection Summary						
Average Delay	0.1					
Intersection Capacity Utilization	32.7%			ICU Level of Service	A	
Analysis Period (min)	15					

HCM Signalized Intersection Capacity Analysis

17: CO 83 & Hogden Rd

09/17/2021

Movement	EBL	EBT	EBR	WBL	WBT	WBR	NBL	NBT	NBR	SBL	SBT	SBR
Lane Configurations												
Traffic Volume (vph)	55	65	41	198	117	202	44	141	57	70	195	24
Future Volume (vph)	55	65	41	198	117	202	44	141	57	70	195	24
Ideal Flow (vphpl)	1900	1900	1900	1900	1900	1900	1900	1900	1900	1900	1900	1900
Total Lost time (s)	6.0	6.0	6.0	6.0	6.0	6.0	6.0	7.0	7.0	6.0	7.0	
Lane Util. Factor	1.00	1.00	1.00	1.00	1.00	1.00	1.00	1.00	1.00	1.00	1.00	
Frt	1.00	1.00	0.85	1.00	1.00	0.85	1.00	1.00	0.85	1.00	0.98	
Flt Protected	0.95	1.00	1.00	0.95	1.00	1.00	0.95	1.00	1.00	0.95	1.00	
Satd. Flow (prot)	1597	1681	1429	1597	1681	1429	1597	1681	1429	1597	1653	
Flt Permitted	0.95	1.00	1.00	0.95	1.00	1.00	0.60	1.00	1.00	0.64	1.00	
Satd. Flow (perm)	1597	1681	1429	1597	1681	1429	1007	1681	1429	1084	1653	
Peak-hour factor, PHF	0.71	0.71	0.71	0.92	0.92	0.92	0.89	0.89	0.89	0.94	0.94	0.94
Growth Factor (vph)	50%	100%	100%	100%	100%	100%	100%	100%	100%	100%	100%	100%
Adj. Flow (vph)	39	92	58	215	127	220	49	158	64	74	207	26
RTOR Reduction (vph)	0	0	53	0	0	178	0	0	39	0	3	0
Lane Group Flow (vph)	39	92	5	215	127	42	49	158	25	74	230	0
Turn Type	Split	NA	Perm	Split	NA	Perm	pm+pt	NA	Perm	pm+pt	NA	
Protected Phases	4	4		8	8		5	2		1	6	
Permitted Phases			4			8	2		2	6		
Actuated Green, G (s)	8.8	8.8	8.8	18.3	18.3	18.3	42.4	36.8	36.8	43.8	37.5	
Effective Green, g (s)	8.8	8.8	8.8	18.3	18.3	18.3	42.4	36.8	36.8	43.8	37.5	
Actuated g/C Ratio	0.09	0.09	0.09	0.19	0.19	0.19	0.45	0.39	0.39	0.46	0.39	
Clearance Time (s)	6.0	6.0	6.0	6.0	6.0	6.0	6.0	7.0	7.0	6.0	7.0	
Vehicle Extension (s)	3.0	3.0	3.0	3.0	3.0	3.0	3.0	3.0	3.0	3.0	3.0	
Lane Grp Cap (vph)	147	155	132	306	323	274	483	649	552	532	651	
v/s Ratio Prot	0.02	c0.05		c0.13	0.08		0.01	0.09		c0.01	c0.14	
v/s Ratio Perm			0.00			0.03	0.04		0.02	0.05		
v/c Ratio	0.27	0.59	0.04	0.70	0.39	0.15	0.10	0.24	0.04	0.14	0.35	
Uniform Delay, d1	40.2	41.5	39.4	35.9	33.6	32.0	15.1	19.8	18.2	14.6	20.3	
Progression Factor	1.00	1.00	1.00	1.00	1.00	1.00	1.00	1.00	1.00	1.00	1.00	
Incremental Delay, d2	1.0	6.0	0.1	7.1	0.8	0.3	0.1	0.2	0.0	0.1	0.3	
Delay (s)	41.2	47.5	39.5	43.0	34.4	32.3	15.2	20.0	18.3	14.7	20.6	
Level of Service	D	D	D	D	C	C	B	B	B	B	C	
Approach Delay (s)		43.7			36.9			18.7			19.2	
Approach LOS		D			D			B			B	
Intersection Summary												
HCM 2000 Control Delay			30.1				HCM 2000 Level of Service				C	
HCM 2000 Volume to Capacity ratio			0.46									
Actuated Cycle Length (s)			95.2				Sum of lost time (s)				25.0	
Intersection Capacity Utilization			67.6%				ICU Level of Service				C	
Analysis Period (min)			15									
c Critical Lane Group												

HCM Unsignalized Intersection Capacity Analysis
 18: CO 83 & Walden Way























09/17/2021



Movement	WBL	WBR	NBT	NBR	SBL	SBT
Lane Configurations						
Traffic Volume (veh/h)	4	38	364	3	10	290
Future Volume (Veh/h)	4	38	364	3	10	290
Sign Control	Stop		Free		Free	
Grade	0%		0%		0%	
Peak Hour Factor	0.35	0.35	0.93	0.93	0.90	0.90
Hourly flow rate (vph)	11	109	391	3	11	322
Pedestrians						
Lane Width (ft)						
Walking Speed (ft/s)						
Percent Blockage						
Right turn flare (veh)						
Median type			None		None	
Median storage (veh)						
Upstream signal (ft)						
pX, platoon unblocked						
vC, conflicting volume	736	392			394	
vC1, stage 1 conf vol						
vC2, stage 2 conf vol						
vCu, unblocked vol	736	392			394	
tC, single (s)	6.5	6.3			4.2	
tC, 2 stage (s)						
tF (s)	3.6	3.4			2.3	
p0 queue free %	97	83			99	
cM capacity (veh/h)	367	633			1107	
Direction, Lane #						
	WB 1	NB 1	SB 1			
Volume Total	120	394	333			
Volume Left	11	0	11			
Volume Right	109	3	0			
cSH	593	1700	1107			
Volume to Capacity	0.20	0.23	0.01			
Queue Length 95th (ft)	19	0	1			
Control Delay (s)	12.6	0.0	0.4			
Lane LOS	B		A			
Approach Delay (s)	12.6	0.0	0.4			
Approach LOS	B					
Intersection Summary						
Average Delay			1.9			
Intersection Capacity Utilization		33.3%		ICU Level of Service		A
Analysis Period (min)		15				

HCM Signalized Intersection Capacity Analysis
 19: CO 83 & CR 105/Walker Rd

09/17/2021

												
Movement	EBL	EBT	EBR	WBL	WBT	WBR	NBL	NBT	NBR	SBL	SBT	SBR
Lane Configurations												
Traffic Volume (vph)	38	120	97	47	141	38	162	188	67	35	159	54
Future Volume (vph)	38	120	97	47	141	38	162	188	67	35	159	54
Ideal Flow (vphpl)	1900	1900	1900	1900	1900	1900	1900	1900	1900	1900	1900	1900
Total Lost time (s)		6.0	4.0		6.0	6.0	5.0	7.0	7.0	5.0	7.0	7.0
Lane Util. Factor		1.00	1.00		1.00	1.00	1.00	1.00	1.00	1.00	1.00	1.00
Frt		1.00	0.85		1.00	0.85	1.00	1.00	0.85	1.00	1.00	0.85
Flt Protected		0.99	1.00		0.99	1.00	0.95	1.00	1.00	0.95	1.00	1.00
Satd. Flow (prot)		1662	1429		1661	1429	1597	1681	1429	1597	1681	1429
Flt Permitted		0.74	1.00		0.77	1.00	0.55	1.00	1.00	0.64	1.00	1.00
Satd. Flow (perm)		1244	1429		1290	1429	926	1681	1429	1071	1681	1429
Peak-hour factor, PHF	0.64	0.64	0.64	0.65	0.65	0.65	0.98	0.98	0.98	0.83	0.83	0.83
Adj. Flow (vph)	59	188	152	72	217	58	165	192	68	42	192	65
RTOR Reduction (vph)	0	0	0	0	0	41	0	0	37	0	0	40
Lane Group Flow (vph)	0	247	152	0	289	17	165	192	31	42	192	25
Turn Type	Perm	NA	Free	Perm	NA	Perm	pm+pt	NA	Perm	pm+pt	NA	Perm
Protected Phases		4			8		5	2		1	6	
Permitted Phases	4		Free	8		8	2		2	6		6
Actuated Green, G (s)		24.0	84.0		24.0	24.0	47.0	37.9	37.9	36.1	32.0	32.0
Effective Green, g (s)		24.0	84.0		24.0	24.0	47.0	37.9	37.9	36.1	32.0	32.0
Actuated g/C Ratio		0.29	1.00		0.29	0.29	0.56	0.45	0.45	0.43	0.38	0.38
Clearance Time (s)		6.0			6.0	6.0	5.0	7.0	7.0	5.0	7.0	7.0
Vehicle Extension (s)		3.0			3.0	3.0	3.0	3.0	3.0	3.0	3.0	3.0
Lane Grp Cap (vph)		355	1429		368	408	598	758	644	485	640	544
v/s Ratio Prot							c0.03	0.11		0.00	c0.11	
v/s Ratio Perm		0.20	0.11		c0.22	0.01	0.12		0.02	0.03		0.02
v/c Ratio		0.70	0.11		0.79	0.04	0.28	0.25	0.05	0.09	0.30	0.05
Uniform Delay, d1		26.7	0.0		27.6	21.7	9.3	14.3	12.9	14.0	18.2	16.4
Progression Factor		1.00	1.00		1.00	1.00	1.00	1.00	1.00	1.00	1.00	1.00
Incremental Delay, d2		5.8	0.1		10.5	0.0	0.3	0.2	0.0	0.1	0.3	0.0
Delay (s)		32.6	0.1		38.1	21.7	9.5	14.5	13.0	14.1	18.4	16.4
Level of Service		C	A		D	C	A	B	B	B	B	B
Approach Delay (s)		20.2			35.4			12.3			17.4	
Approach LOS		C			D			B			B	
Intersection Summary												
HCM 2000 Control Delay			20.9									HCM 2000 Level of Service C
HCM 2000 Volume to Capacity ratio			0.48									
Actuated Cycle Length (s)			84.0									Sum of lost time (s) 18.0
Intersection Capacity Utilization			72.4%									ICU Level of Service C
Analysis Period (min)			15									

c Critical Lane Group

HCM Signalized Intersection Capacity Analysis
 20: CO 83 & E Palmer Divide Ave

09/17/2021



Movement	EBL	EBT	EBR	WBL	WBT	WBR	NBL	NBT	NBR	SBL	SBT	SBR
Lane Configurations		↔			↔		↗	↖		↗	↖	
Traffic Volume (vph)	11	14	58	87	38	10	80	164	17	0	92	14
Future Volume (vph)	11	14	58	87	38	10	80	164	17	0	92	14
Ideal Flow (vphpl)	1900	1900	1900	1900	1900	1900	1900	1900	1900	1900	1900	1900
Total Lost time (s)		7.0			7.0		8.0	8.0			8.0	
Lane Util. Factor		1.00			1.00		1.00	1.00			1.00	
Frt		0.91			0.99		1.00	0.99			0.98	
Flt Protected		0.99			0.97		0.95	1.00			1.00	
Satd. Flow (prot)		1512			1613		1597	1658			1648	
Flt Permitted		0.92			0.73		0.68	1.00			1.00	
Satd. Flow (perm)		1408			1222		1136	1658			1648	
Peak-hour factor, PHF	0.69	0.69	0.69	0.89	0.89	0.89	0.93	0.93	0.93	0.84	0.84	0.84
Adj. Flow (vph)	16	20	84	98	43	11	86	176	18	0	110	17
RTOR Reduction (vph)	0	64	0	0	3	0	0	5	0	0	7	0
Lane Group Flow (vph)	0	56	0	0	149	0	86	189	0	0	120	0
Turn Type	Perm	NA		Perm	NA		Perm	NA		Perm	NA	
Protected Phases		4			8			2			6	
Permitted Phases	4			8			2			6		
Actuated Green, G (s)		9.5			9.5		16.0	16.0			16.0	
Effective Green, g (s)		9.5			9.5		16.0	16.0			16.0	
Actuated g/C Ratio		0.23			0.23		0.40	0.40			0.40	
Clearance Time (s)		7.0			7.0		8.0	8.0			8.0	
Vehicle Extension (s)		5.0			5.0		5.0	5.0			5.0	
Lane Grp Cap (vph)		330			286		448	655			651	
v/s Ratio Prot								c0.11			0.07	
v/s Ratio Perm		0.04			c0.12		0.08					
v/c Ratio		0.17			0.52		0.19	0.29			0.18	
Uniform Delay, d1		12.4			13.5		8.0	8.4			8.0	
Progression Factor		1.00			1.00		1.00	1.00			1.00	
Incremental Delay, d2		0.5			3.2		0.4	0.5			0.3	
Delay (s)		12.9			16.7		8.5	8.9			8.3	
Level of Service		B			B		A	A			A	
Approach Delay (s)		12.9			16.7			8.7			8.3	
Approach LOS		B			B			A			A	

Intersection Summary

HCM 2000 Control Delay	11.2	HCM 2000 Level of Service	B
HCM 2000 Volume to Capacity ratio	0.37		
Actuated Cycle Length (s)	40.5	Sum of lost time (s)	15.0
Intersection Capacity Utilization	39.1%	ICU Level of Service	A
Analysis Period (min)	15		

c Critical Lane Group

HCM Signalized Intersection Capacity Analysis

1: CO 83 & SO 21 SB

09/01/2021



Movement	NWL	NWR	NET	NER	SWL	SWT
Lane Configurations			↑↑	↑	↑	↑↑
Traffic Volume (vph)	0	0	436	868	661	924
Future Volume (vph)	0	0	436	868	661	924
Ideal Flow (vphpl)	1900	1900	1900	1900	1900	1900
Total Lost time (s)			7.5	4.0	5.0	7.5
Lane Util. Factor			0.95	1.00	1.00	0.95
Frt			1.00	0.85	1.00	1.00
Flt Protected			1.00	1.00	0.95	1.00
Satd. Flow (prot)			3195	1429	1597	3195
Flt Permitted			1.00	1.00	0.45	1.00
Satd. Flow (perm)			3195	1429	751	3195
Peak-hour factor, PHF	0.92	0.92	0.91	0.91	0.90	0.90
Adj. Flow (vph)	0	0	479	954	734	1027
RTOR Reduction (vph)	0	0	0	0	0	0
Lane Group Flow (vph)	0	0	479	954	734	1027
Turn Type			NA	Free	pm+pt	NA
Protected Phases			2		1	6
Permitted Phases				Free	6	
Actuated Green, G (s)			70.1	93.3	85.8	93.3
Effective Green, g (s)			70.1	93.3	85.8	93.3
Actuated g/C Ratio			0.75	1.00	0.92	1.00
Clearance Time (s)			7.5		5.0	7.5
Vehicle Extension (s)			1.0		3.0	1.0
Lane Grp Cap (vph)			2400	1429	787	3195
v/s Ratio Prot			0.15		c0.11	0.32
v/s Ratio Perm				0.67	c0.75	
v/c Ratio			0.20	0.67	0.93	0.32
Uniform Delay, d1			3.4	0.0	2.1	0.0
Progression Factor			1.00	1.00	1.00	1.00
Incremental Delay, d2			0.2	2.5	17.7	0.3
Delay (s)			3.6	2.5	19.8	0.3
Level of Service			A	A	B	A
Approach Delay (s)	0.0		2.9			8.4
Approach LOS	A		A			A

Intersection Summary

HCM 2000 Control Delay	5.9	HCM 2000 Level of Service	A
HCM 2000 Volume to Capacity ratio	0.97		
Actuated Cycle Length (s)	93.3	Sum of lost time (s)	12.5
Intersection Capacity Utilization	63.7%	ICU Level of Service	B
Analysis Period (min)	15		

c Critical Lane Group

HCM Signalized Intersection Capacity Analysis

2: CO 83 & CO 21 NB

09/01/2021



Movement	NWL	NWR	NET	NER	SWL	SWT
Lane Configurations						
Traffic Volume (vph)	679	777	432	0	0	900
Future Volume (vph)	679	777	432	0	0	900
Ideal Flow (vphpl)	1900	1900	1900	1900	1900	1900
Total Lost time (s)	6.5	4.0	7.5			6.5
Lane Util. Factor	0.97	1.00	0.95			0.95
Frt	1.00	0.85	1.00			1.00
Flt Protected	0.95	1.00	1.00			1.00
Satd. Flow (prot)	3099	1429	3195			3195
Flt Permitted	0.95	1.00	1.00			1.00
Satd. Flow (perm)	3099	1429	3195			3195
Peak-hour factor, PHF	0.96	0.96	0.90	0.90	0.89	0.89
Adj. Flow (vph)	707	809	480	0	0	1011
RTOR Reduction (vph)	0	0	0	0	0	0
Lane Group Flow (vph)	707	809	480	0	0	1011
Turn Type	Prot	Free	NA			NA
Protected Phases	4		2			6
Permitted Phases		Free				
Actuated Green, G (s)	24.2	88.4	50.2			51.2
Effective Green, g (s)	24.2	88.4	50.2			51.2
Actuated g/C Ratio	0.27	1.00	0.57			0.58
Clearance Time (s)	6.5		7.5			6.5
Vehicle Extension (s)	2.0		1.0			1.0
Lane Grp Cap (vph)	848	1429	1814			1850
v/s Ratio Prot	c0.23		0.15			0.32
v/s Ratio Perm		c0.57				
v/c Ratio	0.83	0.57	0.26			0.55
Uniform Delay, d1	30.2	0.0	9.7			11.5
Progression Factor	1.00	1.00	1.00			1.00
Incremental Delay, d2	6.8	1.6	0.4			1.2
Delay (s)	37.0	1.6	10.1			12.6
Level of Service	D	A	B			B
Approach Delay (s)	18.1		10.1			12.6
Approach LOS	B		B			B





















Intersection Summary

HCM 2000 Control Delay	15.0	HCM 2000 Level of Service	B
HCM 2000 Volume to Capacity ratio	0.71		
Actuated Cycle Length (s)	88.4	Sum of lost time (s)	14.0
Intersection Capacity Utilization	63.7%	ICU Level of Service	B
Analysis Period (min)	15		

c Critical Lane Group

HCM Unsignalized Intersection Capacity Analysis
 3: CO 83 & CDOT Yard

09/01/2021

												
Movement	SEL	SET	SER	NWL	NWT	NWR	NEL	NET	NER	SWL	SWT	SWR
Lane Configurations												
Traffic Volume (veh/h)	1	0	6	0	0	2	2	1195	2	0	901	0
Future Volume (Veh/h)	1	0	6	0	0	2	2	1195	2	0	901	0
Sign Control		Stop			Stop			Free			Free	
Grade		0%			0%			0%			0%	
Peak Hour Factor	0.50	0.50	0.50	0.50	0.50	0.50	0.97	0.97	0.97	0.95	0.95	0.95
Hourly flow rate (vph)	2	0	12	0	0	4	2	1232	2	0	948	0
Pedestrians												2
Lane Width (ft)												12.0
Walking Speed (ft/s)												3.5
Percent Blockage												0
Right turn flare (veh)			4									
Median type								None				None
Median storage veh												
Upstream signal (ft)								760				
pX, platoon unblocked	0.95	0.95		0.95	0.95	0.95				0.95		
vC, conflicting volume	1572	2188	474	1719	2187	619	948			1236		
vC1, stage 1 conf vol												
vC2, stage 2 conf vol												
vCu, unblocked vol	1489	2141	474	1645	2140	481	948			1134		
tC, single (s)	7.8	6.8	7.2	7.8	6.8	7.2	4.4			4.4		
tC, 2 stage (s)												
tF (s)	3.6	4.1	3.4	3.6	4.1	3.4	2.3			2.3		
p0 queue free %	97	100	98	100	100	99	100			100		
cM capacity (veh/h)	72	40	508	54	40	474	656			521		
Direction, Lane #	SE 1	NW 1	NE 1	NE 2	NE 3	SW 1	SW 2	SW 3	SW 4			
Volume Total	14	4	2	821	413	0	474	474	0			
Volume Left	2	0	2	0	0	0	0	0	0			
Volume Right	12	4	0	0	2	0	0	0	0			
cSH	505	474	656	1700	1700	1700	1700	1700	1700			
Volume to Capacity	0.03	0.01	0.00	0.48	0.24	0.00	0.28	0.28	0.00			
Queue Length 95th (ft)	2	1	0	0	0	0	0	0	0			
Control Delay (s)	18.5	12.7	10.5	0.0	0.0	0.0	0.0	0.0	0.0			
Lane LOS	C	B	B									
Approach Delay (s)	18.5	12.7	0.0			0.0						
Approach LOS	C	B										
Intersection Summary												
Average Delay			0.2									
Intersection Capacity Utilization			43.1%		ICU Level of Service					A		
Analysis Period (min)			15									

HCM Signalized Intersection Capacity Analysis

4: CO 83 & Shoup Road

09/01/2021

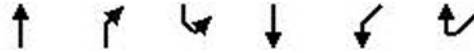

Movement	NBT	NBR	SBL	SBT	SWL	SWR
Lane Configurations	↑↑	↑	↵	↑↑	↵	↵
Traffic Volume (vph)	997	191	161	796	97	166
Future Volume (vph)	997	191	161	796	97	166
Ideal Flow (vphpl)	1900	1900	1900	1900	1900	1900
Total Lost time (s)	7.5	4.0	5.0	7.5	6.0	4.0
Lane Util. Factor	0.95	1.00	1.00	0.95	1.00	1.00
Frt	1.00	0.85	1.00	1.00	1.00	0.85
Flt Protected	1.00	1.00	0.95	1.00	0.95	1.00
Satd. Flow (prot)	3195	1429	1597	3195	1597	1429
Flt Permitted	1.00	1.00	0.20	1.00	0.95	1.00
Satd. Flow (perm)	3195	1429	343	3195	1597	1429
Peak-hour factor, PHF	0.97	0.97	0.93	0.93	0.79	0.79
Adj. Flow (vph)	1028	197	173	856	123	210
RTOR Reduction (vph)	0	0	0	0	0	0
Lane Group Flow (vph)	1028	197	173	856	123	210
Turn Type	NA	Free	pm+pt	NA	Prot	Free
Protected Phases	2		1	6	8	
Permitted Phases		Free	6			Free
Actuated Green, G (s)	45.2	82.4	57.1	57.1	11.8	82.4
Effective Green, g (s)	45.2	82.4	57.1	57.1	11.8	82.4
Actuated g/C Ratio	0.55	1.00	0.69	0.69	0.14	1.00
Clearance Time (s)	7.5		5.0	7.5	6.0	
Vehicle Extension (s)	1.0		1.0	1.0	3.0	
Lane Grp Cap (vph)	1752	1429	342	2214	228	1429
v/s Ratio Prot	c0.32		c0.04	0.27	c0.08	
v/s Ratio Perm		0.14	0.31			0.15
v/c Ratio	0.59	0.14	0.51	0.39	0.54	0.15
Uniform Delay, d1	12.4	0.0	6.1	5.3	32.8	0.0
Progression Factor	1.00	1.00	1.00	1.00	1.00	1.00
Incremental Delay, d2	1.4	0.2	0.4	0.5	2.4	0.2
Delay (s)	13.8	0.2	6.5	5.8	35.2	0.2
Level of Service	B	A	A	A	D	A
Approach Delay (s)	11.6			5.9	13.1	
Approach LOS	B			A	B	

Intersection Summary

HCM 2000 Control Delay	9.6	HCM 2000 Level of Service	A
HCM 2000 Volume to Capacity ratio	0.57		
Actuated Cycle Length (s)	82.4	Sum of lost time (s)	18.5
Intersection Capacity Utilization	57.3%	ICU Level of Service	B
Analysis Period (min)	15		

c Critical Lane Group

HCM Signalized Intersection Capacity Analysis

5: CO 83 & Flying Horse Club Dr/Abert Way

09/01/2021

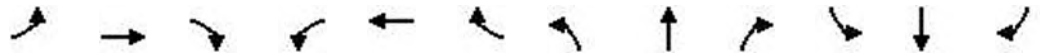

Movement	EBL	EBT	EBR	WBL	WBT	WBR	NBL	NBT	NBR	SBL	SBT	SBR
Lane Configurations												
Traffic Volume (vph)	19	1	121	3	0	5	181	963	7	5	845	23
Future Volume (vph)	19	1	121	3	0	5	181	963	7	5	845	23
Ideal Flow (vphpl)	1900	1900	1900	1900	1900	1900	1900	1900	1900	1900	1900	1900
Total Lost time (s)	7.0	7.0	7.0	7.0	7.0		7.0	8.0	8.0	7.0	8.0	8.0
Lane Util. Factor	1.00	1.00	1.00	1.00	1.00		1.00	0.95	1.00	1.00	0.95	1.00
Frpb, ped/bikes	1.00	1.00	1.00	1.00	1.00		1.00	1.00	0.98	1.00	1.00	1.00
Flpb, ped/bikes	1.00	1.00	1.00	1.00	1.00		1.00	1.00	1.00	1.00	1.00	1.00
Frt	1.00	1.00	0.85	1.00	0.85		1.00	1.00	0.85	1.00	1.00	0.85
Flt Protected	0.95	1.00	1.00	0.95	1.00		0.95	1.00	1.00	0.95	1.00	1.00
Satd. Flow (prot)	1597	1681	1429	1597	1429		1597	3195	1394	1596	3195	1429
Flt Permitted	0.75	1.00	1.00	0.76	1.00		0.22	1.00	1.00	0.29	1.00	1.00
Satd. Flow (perm)	1266	1681	1429	1273	1429		371	3195	1394	490	3195	1429
Peak-hour factor, PHF	0.80	0.80	0.80	0.69	0.69	0.69	0.98	0.98	0.98	0.92	0.92	0.92
Adj. Flow (vph)	24	1	151	4	0	7	185	983	7	5	918	25
RTOR Reduction (vph)	0	0	136	0	6	0	0	0	3	0	0	12
Lane Group Flow (vph)	24	1	15	4	1	0	185	983	4	5	918	13
Confl. Peds. (#/hr)									6	6		
Turn Type	Perm	NA	Perm	Perm	NA		pm+pt	NA	Perm	pm+pt	NA	Perm
Protected Phases		4			8		5	2		1	6	
Permitted Phases	4		4	8			2		2	6		6
Actuated Green, G (s)	8.0	8.0	8.0	8.0	8.0		59.0	51.0	51.0	42.2	41.2	41.2
Effective Green, g (s)	8.0	8.0	8.0	8.0	8.0		59.0	51.0	51.0	42.2	41.2	41.2
Actuated g/C Ratio	0.10	0.10	0.10	0.10	0.10		0.72	0.62	0.62	0.51	0.50	0.50
Clearance Time (s)	7.0	7.0	7.0	7.0	7.0		7.0	8.0	8.0	7.0	8.0	8.0
Vehicle Extension (s)	3.0	3.0	3.0	3.0	3.0		3.0	3.0	3.0	3.0	3.0	3.0
Lane Grp Cap (vph)	123	164	139	124	139		428	1987	867	265	1605	717
v/s Ratio Prot		0.00			0.00		c0.06	c0.31		0.00	c0.29	
v/s Ratio Perm	c0.02		0.01	0.00			0.25		0.00	0.01		0.01
v/c Ratio	0.20	0.01	0.11	0.03	0.00		0.43	0.49	0.01	0.02	0.57	0.02
Uniform Delay, d1	34.0	33.4	33.7	33.5	33.4		5.5	8.5	5.9	9.7	14.2	10.2
Progression Factor	1.00	1.00	1.00	1.00	1.00		1.00	1.00	1.00	1.00	1.00	1.00
Incremental Delay, d2	0.8	0.0	0.3	0.1	0.0		0.7	0.2	0.0	0.0	0.5	0.0
Delay (s)	34.8	33.4	34.1	33.6	33.4		6.2	8.7	5.9	9.7	14.7	10.3
Level of Service	C	C	C	C	C		A	A	A	A	B	B
Approach Delay (s)		34.2			33.5			8.3			14.6	
Approach LOS		C			C			A			B	

Intersection Summary

HCM 2000 Control Delay	13.0	HCM 2000 Level of Service	B
HCM 2000 Volume to Capacity ratio	0.52		
Actuated Cycle Length (s)	82.0	Sum of lost time (s)	22.0
Intersection Capacity Utilization	65.2%	ICU Level of Service	C
Analysis Period (min)	15		
c Critical Lane Group			

HCM Signalized Intersection Capacity Analysis

6: CO 83 & North Gate Blvd

09/01/2021



Movement	EBL	EBT	EBR	WBL	WBT	WBR	NBL	NBT	NBR	SBL	SBT	SBR
Lane Configurations												
Traffic Volume (vph)	94	0	412	0	2	0	391	585	0	0	567	82
Future Volume (vph)	94	0	412	0	2	0	391	585	0	0	567	82
Ideal Flow (vphpl)	1900	1900	1900	1900	1900	1900	1900	1900	1900	1900	1900	1900
Total Lost time (s)	6.0		6.0		6.0		5.0	7.0			7.0	7.0
Lane Util. Factor	1.00		1.00		1.00		1.00	0.95			0.95	1.00
Frbp, ped/bikes	1.00		1.00		1.00		1.00	1.00			1.00	1.00
Flpb, ped/bikes	1.00		1.00		1.00		1.00	1.00			1.00	1.00
Frt	1.00		0.85		1.00		1.00	1.00			1.00	0.85
Flt Protected	0.95		1.00		1.00		0.95	1.00			1.00	1.00
Satd. Flow (prot)	1438		1286		1513		1438	2875			2875	1286
Flt Permitted	0.76		1.00		1.00		0.36	1.00			1.00	1.00
Satd. Flow (perm)	1143		1286		1513		547	2875			2875	1286
Peak-hour factor, PHF	0.92	0.92	0.92	0.50	0.50	0.50	0.94	0.94	0.94	0.96	0.96	0.96
Adj. Flow (vph)	102	0	448	0	4	0	416	622	0	0	591	85
RTOR Reduction (vph)	0	0	375	0	0	0	0	0	0	0	0	42
Lane Group Flow (vph)	102	0	73	0	4	0	416	622	0	0	591	43
Confl. Peds. (#/hr)									7	7		
Turn Type	Perm		Perm		NA		pm+pt	NA		Perm	NA	Perm
Protected Phases		4			8		5	2			6	
Permitted Phases	4		4	8			2			6		6
Actuated Green, G (s)	16.5		16.5		16.5		89.4	89.4			60.2	60.2
Effective Green, g (s)	16.5		16.5		16.5		89.4	89.4			60.2	60.2
Actuated g/C Ratio	0.14		0.14		0.14		0.75	0.75			0.51	0.51
Clearance Time (s)	6.0		6.0		6.0		5.0	7.0			7.0	7.0
Vehicle Extension (s)	3.0		3.0		3.0		3.0	3.0			3.0	3.0
Lane Grp Cap (vph)	158		178		209		592	2161			1455	651
v/s Ratio Prot					0.00		c0.14	0.22			0.21	
v/s Ratio Perm	c0.09		0.06				c0.39					0.03
v/c Ratio	0.65		0.41		0.02		0.70	0.29			0.41	0.07
Uniform Delay, d1	48.4		46.7		44.2		6.4	4.7			18.2	15.0
Progression Factor	1.00		1.00		1.00		1.00	1.00			1.00	1.00
Incremental Delay, d2	8.7		1.5		0.0		3.8	0.3			0.8	0.2
Delay (s)	57.2		48.3		44.2		10.2	5.0			19.1	15.2
Level of Service	E		D		D		B	A			B	B
Approach Delay (s)		49.9			44.2			7.1			18.6	
Approach LOS		D			D			A			B	

Intersection Summary

HCM 2000 Control Delay	21.0	HCM 2000 Level of Service	C
HCM 2000 Volume to Capacity ratio	0.72		
Actuated Cycle Length (s)	118.9	Sum of lost time (s)	18.0
Intersection Capacity Utilization	70.7%	ICU Level of Service	C
Analysis Period (min)	15		
c Critical Lane Group			

HCM Unsignalized Intersection Capacity Analysis

7: CO 83 & Private Drive

09/01/2021



Movement	WBL	WBR	NBT	NBR	SBL	SBT
Lane Configurations						
Traffic Volume (veh/h)	1	1	648	2	0	572
Future Volume (Veh/h)	1	1	648	2	0	572
Sign Control	Stop		Free		Free	
Grade	0%		0%		0%	
Peak Hour Factor	0.25	0.25	0.91	0.91	0.94	0.94
Hourly flow rate (vph)	4	4	712	2	0	609
Pedestrians						
Lane Width (ft)						
Walking Speed (ft/s)						
Percent Blockage						
Right turn flare (veh)						
Median type	None			None		
Median storage (veh)						
Upstream signal (ft)						
pX, platoon unblocked						
vC, conflicting volume	1018	713			714	
vC1, stage 1 conf vol						
vC2, stage 2 conf vol						
vCu, unblocked vol	1018	713			714	
tC, single (s)	7.1	7.2			4.4	
tC, 2 stage (s)						
tF (s)	3.6	3.4			2.3	
p0 queue free %	98	99			100	
cM capacity (veh/h)	216	350			813	
Direction, Lane #	WB 1	NB 1	SB 1	SB 2	SB 3	
Volume Total	8	714	0	304	304	
Volume Left	4	0	0	0	0	
Volume Right	4	2	0	0	0	
cSH	267	1700	1700	1700	1700	
Volume to Capacity	0.03	0.42	0.00	0.18	0.18	
Queue Length 95th (ft)	2	0	0	0	0	
Control Delay (s)	18.9	0.0	0.0	0.0	0.0	
Lane LOS	C					
Approach Delay (s)	18.9	0.0	0.0			
Approach LOS	C					
Intersection Summary						
Average Delay			0.1			
Intersection Capacity Utilization			44.2%	ICU Level of Service	A	
Analysis Period (min)			15			

HCM Unsignalized Intersection Capacity Analysis
 8: CO 83 & Old North Gate Rd

09/01/2021



Movement	EBL	EBR	NBL	NBT	SBT	SBR
Lane Configurations						
Traffic Volume (veh/h)	3	78	139	533	471	4
Future Volume (Veh/h)	3	78	139	533	471	4
Sign Control	Stop			Free	Free	
Grade	0%			0%	0%	
Peak Hour Factor	0.78	0.78	0.91	0.91	0.94	0.94
Hourly flow rate (vph)	4	100	153	586	501	4
Pedestrians						
Lane Width (ft)						
Walking Speed (ft/s)						
Percent Blockage						
Right turn flare (veh)	2					
Median type				None	None	
Median storage (veh)						
Upstream signal (ft)						
pX, platoon unblocked						
vC, conflicting volume	1395	503	505			
vC1, stage 1 conf vol						
vC2, stage 2 conf vol						
vCu, unblocked vol	1395	503	505			
tC, single (s)	6.5	6.3	4.2			
tC, 2 stage (s)						
tF (s)	3.6	3.4	2.3			
p0 queue free %	97	82	85			
cM capacity (veh/h)	125	547	1005			
Direction, Lane #	EB 1	NB 1	NB 2	SB 1		
Volume Total	104	153	586	505		
Volume Left	4	153	0	0		
Volume Right	100	0	0	4		
cSH	569	1005	1700	1700		
Volume to Capacity	0.18	0.15	0.34	0.30		
Queue Length 95th (ft)	17	13	0	0		
Control Delay (s)	13.9	9.2	0.0	0.0		
Lane LOS	B	A				
Approach Delay (s)	13.9	1.9	0.0			
Approach LOS	B					
Intersection Summary						
Average Delay			2.1			
Intersection Capacity Utilization			46.1%	ICU Level of Service	A	
Analysis Period (min)			15			

Intersection Sign configuration not allowed in HCM analysis.

HCM Unsignalized Intersection Capacity Analysis
 10: Shamrock Ranch Rd & CO 83

09/01/2021



Movement	EBT	EBR	WBL	WBT	NWL	NWR
Lane Configurations	↻			↻	↻	
Traffic Volume (veh/h)	529	2	0	470	0	0
Future Volume (Veh/h)	529	2	0	470	0	0
Sign Control	Free			Free	Stop	
Grade	0%			0%	0%	
Peak Hour Factor	0.91	0.91	0.93	0.93	0.92	0.92
Hourly flow rate (vph)	581	2	0	505	0	0
Pedestrians						
Lane Width (ft)						
Walking Speed (ft/s)						
Percent Blockage						
Right turn flare (veh)						
Median type	None		None			
Median storage (veh)						
Upstream signal (ft)						
pX, platoon unblocked						
vC, conflicting volume			583		1087	582
vC1, stage 1 conf vol						
vC2, stage 2 conf vol						
vCu, unblocked vol			583		1087	582
tC, single (s)			4.2		6.5	6.3
tC, 2 stage (s)						
tF (s)			2.3		3.6	3.4
p0 queue free %			100		100	100
cM capacity (veh/h)			939		228	493
Direction, Lane #	EB 1	WB 1	NW 1			
Volume Total	583	505	0			
Volume Left	0	0	0			
Volume Right	2	0	0			
cSH	1700	939	1700			
Volume to Capacity	0.34	0.00	0.00			
Queue Length 95th (ft)	0	0	0			
Control Delay (s)	0.0	0.0	0.0			
Lane LOS			A			
Approach Delay (s)	0.0	0.0	0.0			
Approach LOS			A			
Intersection Summary						
Average Delay			0.0			
Intersection Capacity Utilization			31.3%	ICU Level of Service	A	
Analysis Period (min)			15			

HCM Unsignalized Intersection Capacity Analysis

11: CO 83 & Kaessner Lane





















09/01/2021



Movement	EBL	EBR	NBL	NBT	SBT	SBR
Lane Configurations						
Traffic Volume (veh/h)	2	5	5	525	475	4
Future Volume (Veh/h)	2	5	5	525	475	4
Sign Control	Stop			Free	Free	
Grade	0%			0%	0%	
Peak Hour Factor	0.44	0.44	0.92	0.92	0.91	0.91
Hourly flow rate (vph)	5	11	5	571	522	4
Pedestrians						
Lane Width (ft)						
Walking Speed (ft/s)						
Percent Blockage						
Right turn flare (veh)						
Median type				None	None	
Median storage (veh)						
Upstream signal (ft)						
pX, platoon unblocked						
vC, conflicting volume	1105	524	526			
vC1, stage 1 conf vol						
vC2, stage 2 conf vol						
vCu, unblocked vol	1105	524	526			
tC, single (s)	6.5	6.3	4.2			
tC, 2 stage (s)						
tF (s)	3.6	3.4	2.3			
p0 queue free %	98	98	99			
cM capacity (veh/h)	221	532	987			
Direction, Lane #	EB 1	NB 1	SB 1			
Volume Total	16	576	526			
Volume Left	5	5	0			
Volume Right	11	0	4			
cSH	370	987	1700			
Volume to Capacity	0.04	0.01	0.31			
Queue Length 95th (ft)	3	0	0			
Control Delay (s)	15.2	0.1	0.0			
Lane LOS	C	A				
Approach Delay (s)	15.2	0.1	0.0			
Approach LOS	C					
Intersection Summary						
Average Delay	0.3					
Intersection Capacity Utilization	41.6%			ICU Level of Service	A	
Analysis Period (min)	15					

HCM Unsignalized Intersection Capacity Analysis
 12: CO 83 & Stagecoach Rd

09/01/2021

												
Movement	EBL	EBT	EBR	WBL	WBT	WBR	NBL	NBT	NBR	SBL	SBT	SBR
Lane Configurations												
Traffic Volume (veh/h)	1	0	5	37	1	12	2	510	18	7	434	1
Future Volume (Veh/h)	1	0	5	37	1	12	2	510	18	7	434	1
Sign Control		Stop			Stop			Free			Free	
Grade		0%			0%			0%			0%	
Peak Hour Factor	0.50	0.50	0.50	0.83	0.83	0.83	0.90	0.90	0.90	0.89	0.89	0.89
Hourly flow rate (vph)	2	0	10	45	1	14	2	567	20	8	488	1
Pedestrians												
Lane Width (ft)												
Walking Speed (ft/s)												
Percent Blockage												
Right turn flare (veh)	6											
Median type							None			None		
Median storage veh												
Upstream signal (ft)												
pX, platoon unblocked												
vC, conflicting volume	1083	1096	488	1085	1076	567	489					587
vC1, stage 1 conf vol												
vC2, stage 2 conf vol												
vCu, unblocked vol	1083	1096	488	1085	1076	567	489					587
tC, single (s)	7.2	6.6	6.3	7.2	6.6	6.3	4.2					4.2
tC, 2 stage (s)												
tF (s)	3.6	4.1	3.4	3.6	4.1	3.4	2.3					2.3
p0 queue free %	99	100	98	75	100	97	100					99
cM capacity (veh/h)	178	202	558	180	207	503	1020					936
Direction, Lane #	EB 1	WB 1	NB 1	NB 2	SB 1	SB 2						
Volume Total	12	60	569	20	8	489						
Volume Left	2	45	2	0	8	0						
Volume Right	10	14	0	20	0	1						
cSH	412	236	1020	1700	936	1700						
Volume to Capacity	0.03	0.25	0.00	0.01	0.01	0.29						
Queue Length 95th (ft)	2	25	0	0	1	0						
Control Delay (s)	14.0	27.1	0.1	0.0	8.9	0.0						
Lane LOS	B	D	A		A							
Approach Delay (s)	14.0	27.1	0.1		0.1							
Approach LOS	B	D										
Intersection Summary												
Average Delay			1.6									
Intersection Capacity Utilization			43.9%		ICU Level of Service				A			
Analysis Period (min)			15									

HCM Unsignalized Intersection Capacity Analysis

13: CO 83 & Private Access

09/01/2021



Movement	EBL	EBR	NBL	NBT	SBT	SBR
Lane Configurations						
Traffic Volume (veh/h)	1	0	0	516	449	1
Future Volume (Veh/h)	1	0	0	516	449	1
Sign Control	Stop			Free	Free	
Grade	0%			0%	0%	
Peak Hour Factor	0.25	0.25	0.90	0.90	0.87	0.87
Hourly flow rate (vph)	4	0	0	573	516	1
Pedestrians						
Lane Width (ft)						
Walking Speed (ft/s)						
Percent Blockage						
Right turn flare (veh)						
Median type				None	None	
Median storage (veh)						
Upstream signal (ft)						
pX, platoon unblocked						
vC, conflicting volume	1090	516	517			
vC1, stage 1 conf vol						
vC2, stage 2 conf vol						
vCu, unblocked vol	1090	516	517			
tC, single (s)	6.5	6.3	4.2			
tC, 2 stage (s)						
tF (s)	3.6	3.4	2.3			
p0 queue free %	98	100	100			
cM capacity (veh/h)	227	537	995			
Direction, Lane #	EB 1	NB 1	SB 1			
Volume Total	4	573	517			
Volume Left	4	0	0			
Volume Right	0	0	1			
cSH	227	995	1700			
Volume to Capacity	0.02	0.00	0.30			
Queue Length 95th (ft)	1	0	0			
Control Delay (s)	21.1	0.0	0.0			
Lane LOS	C					
Approach Delay (s)	21.1	0.0	0.0			
Approach LOS	C					
Intersection Summary						
Average Delay			0.1			
Intersection Capacity Utilization			37.2%	ICU Level of Service	A	
Analysis Period (min)			15			

HCM Unsignalized Intersection Capacity Analysis

14: CO 83 & Benet Lane











09/01/2021



Movement	EBL	EBR	NBL	NBT	SBT	SBR
Lane Configurations						
Traffic Volume (veh/h)	2	3	0	519	447	1
Future Volume (Veh/h)	2	3	0	519	447	1
Sign Control	Stop			Free	Free	
Grade	0%			0%	0%	
Peak Hour Factor	0.50	0.50	0.90	0.90	0.89	0.89
Hourly flow rate (vph)	4	6	0	577	502	1
Pedestrians						
Lane Width (ft)						
Walking Speed (ft/s)						
Percent Blockage						
Right turn flare (veh)						
Median type				None	None	
Median storage (veh)						
Upstream signal (ft)						
pX, platoon unblocked						
vC, conflicting volume	1080	502	503			
vC1, stage 1 conf vol						
vC2, stage 2 conf vol						
vCu, unblocked vol	1080	502	503			
tC, single (s)	6.5	6.3	4.2			
tC, 2 stage (s)						
tF (s)	3.6	3.4	2.3			
p0 queue free %	98	99	100			
cM capacity (veh/h)	230	548	1007			
Direction, Lane #	EB 1	NB 1	NB 2	SB 1		
Volume Total	10	0	577	503		
Volume Left	4	0	0	0		
Volume Right	6	0	0	1		
cSH	353	1700	1700	1700		
Volume to Capacity	0.03	0.00	0.34	0.30		
Queue Length 95th (ft)	2	0	0	0		
Control Delay (s)	15.5	0.0	0.0	0.0		
Lane LOS	C					
Approach Delay (s)	15.5	0.0	0.0			
Approach LOS	C					
Intersection Summary						
Average Delay			0.1			
Intersection Capacity Utilization			37.3%	ICU Level of Service	A	
Analysis Period (min)			15			

HCM Unsignalized Intersection Capacity Analysis
 15: CO 83 & High Forest Rd

09/01/2021

						
Movement	WBL	WBR	NBT	NBR	SBL	SBT
Lane Configurations						
Traffic Volume (veh/h)	27	7	481	38	5	414
Future Volume (Veh/h)	27	7	481	38	5	414
Sign Control	Stop		Free		Free	
Grade	0%		0%		0%	
Peak Hour Factor	0.66	0.66	0.93	0.93	0.89	0.89
Hourly flow rate (vph)	41	11	517	41	6	465
Pedestrians						
Lane Width (ft)						
Walking Speed (ft/s)						
Percent Blockage						
Right turn flare (veh)						
Median type	None			None		
Median storage (veh)						
Upstream signal (ft)						
pX, platoon unblocked						
vC, conflicting volume	994	517			558	
vC1, stage 1 conf vol						
vC2, stage 2 conf vol						
vCu, unblocked vol	994	517			558	
tC, single (s)	6.5	6.3			4.2	
tC, 2 stage (s)						
tF (s)	3.6	3.4			2.3	
p0 queue free %	84	98			99	
cM capacity (veh/h)	258	537			960	
Direction, Lane #	WB 1	NB 1	NB 2	SB 1	SB 2	
Volume Total	52	517	41	6	465	
Volume Left	41	0	0	6	0	
Volume Right	11	0	41	0	0	
cSH	290	1700	1700	960	1700	
Volume to Capacity	0.18	0.30	0.02	0.01	0.27	
Queue Length 95th (ft)	16	0	0	0	0	
Control Delay (s)	20.1	0.0	0.0	8.8	0.0	
Lane LOS	C			A		
Approach Delay (s)	20.1	0.0	0.1			
Approach LOS	C					
Intersection Summary						
Average Delay			1.0			
Intersection Capacity Utilization			35.3%	ICU Level of Service	A	
Analysis Period (min)			15			

HCM Unsignalized Intersection Capacity Analysis
 16: CO 83 & Arena Rd

09/01/2021



Movement	EBL	EBR	NBL	NBT	SBT	SBR
Lane Configurations						
Traffic Volume (veh/h)	3	1	3	485	425	0
Future Volume (Veh/h)	3	1	3	485	425	0
Sign Control	Stop			Free	Free	
Grade	0%			0%	0%	
Peak Hour Factor	0.75	0.75	0.95	0.95	0.92	0.92
Hourly flow rate (vph)	4	1	3	511	462	0
Pedestrians						
Lane Width (ft)						
Walking Speed (ft/s)						
Percent Blockage						
Right turn flare (veh)						
Median type				None	None	
Median storage (veh)						
Upstream signal (ft)						
pX, platoon unblocked						
vC, conflicting volume	979	462	462			
vC1, stage 1 conf vol						
vC2, stage 2 conf vol						
vCu, unblocked vol	979	462	462			
tC, single (s)	6.5	6.3	4.2			
tC, 2 stage (s)						
tF (s)	3.6	3.4	2.3			
p0 queue free %	98	100	100			
cM capacity (veh/h)	264	578	1044			
Direction, Lane #	EB 1	NB 1	SB 1			
Volume Total	5	514	462			
Volume Left	4	3	0			
Volume Right	1	0	0			
cSH	296	1044	1700			
Volume to Capacity	0.02	0.00	0.27			
Queue Length 95th (ft)	1	0	0			
Control Delay (s)	17.4	0.1	0.0			
Lane LOS	C	A				
Approach Delay (s)	17.4	0.1	0.0			
Approach LOS	C					
Intersection Summary						
Average Delay	0.1					
Intersection Capacity Utilization	37.9%			ICU Level of Service	A	
Analysis Period (min)	15					

HCM Signalized Intersection Capacity Analysis

17: CO 83 & Hogden Rd

09/01/2021

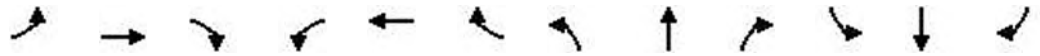

Movement	EBL	EBT	EBR	WBL	WBT	WBR	NBL	NBT	NBR	SBL	SBT	SBR
Lane Configurations												
Traffic Volume (vph)	29	151	47	111	84	112	64	254	161	242	275	46
Future Volume (vph)	29	151	47	111	84	112	64	254	161	242	275	46
Ideal Flow (vphpl)	1900	1900	1900	1900	1900	1900	1900	1900	1900	1900	1900	1900
Total Lost time (s)	6.0	6.0	6.0	6.0	6.0	6.0	6.0	7.0	7.0	6.0	7.0	
Lane Util. Factor	1.00	1.00	1.00	1.00	1.00	1.00	1.00	1.00	1.00	1.00	1.00	
Frt	1.00	1.00	0.85	1.00	1.00	0.85	1.00	1.00	0.85	1.00	0.98	
Flt Protected	0.95	1.00	1.00	0.95	1.00	1.00	0.95	1.00	1.00	0.95	1.00	
Satd. Flow (prot)	1597	1681	1429	1597	1681	1429	1597	1681	1429	1597	1645	
Flt Permitted	0.95	1.00	1.00	0.95	1.00	1.00	0.50	1.00	1.00	0.46	1.00	
Satd. Flow (perm)	1597	1681	1429	1597	1681	1429	833	1681	1429	775	1645	
Peak-hour factor, PHF	0.92	0.92	0.92	0.79	0.79	0.79	0.95	0.95	0.95	0.89	0.89	0.89
Adj. Flow (vph)	32	164	51	141	106	142	67	267	169	272	309	52
RTOR Reduction (vph)	0	0	43	0	0	122	0	0	108	0	4	0
Lane Group Flow (vph)	32	164	8	141	106	20	67	267	61	272	357	0
Turn Type	Split	NA	Perm	Split	NA	Perm	pm+pt	NA	Perm	pm+pt	NA	
Protected Phases	4	4		8	8		5	2		1	6	
Permitted Phases			4			8	2		2	6		
Actuated Green, G (s)	15.5	15.5	15.5	14.7	14.7	14.7	44.5	37.9	37.9	54.5	42.9	
Effective Green, g (s)	15.5	15.5	15.5	14.7	14.7	14.7	44.5	37.9	37.9	54.5	42.9	
Actuated g/C Ratio	0.15	0.15	0.15	0.14	0.14	0.14	0.43	0.36	0.36	0.52	0.41	
Clearance Time (s)	6.0	6.0	6.0	6.0	6.0	6.0	6.0	7.0	7.0	6.0	7.0	
Vehicle Extension (s)	3.0	3.0	3.0	3.0	3.0	3.0	3.0	3.0	3.0	3.0	3.0	
Lane Grp Cap (vph)	236	248	211	224	236	200	402	608	517	494	674	
v/s Ratio Prot	0.02	c0.10		c0.09	0.06		0.01	0.16		c0.06	0.22	
v/s Ratio Perm			0.01			0.01	0.06		0.04	c0.23		
v/c Ratio	0.14	0.66	0.04	0.63	0.45	0.10	0.17	0.44	0.12	0.55	0.53	
Uniform Delay, d1	38.8	42.1	38.2	42.4	41.3	39.2	18.1	25.3	22.3	15.1	23.3	
Progression Factor	1.00	1.00	1.00	1.00	1.00	1.00	1.00	1.00	1.00	1.00	1.00	
Incremental Delay, d2	0.3	6.5	0.1	5.4	1.4	0.2	0.2	0.5	0.1	1.3	0.8	
Delay (s)	39.0	48.6	38.3	47.9	42.6	39.5	18.3	25.8	22.4	16.4	24.0	
Level of Service	D	D	D	D	D	D	B	C	C	B	C	
Approach Delay (s)		45.2			43.4			23.7			20.8	
Approach LOS		D			D			C			C	

Intersection Summary

HCM 2000 Control Delay	30.0	HCM 2000 Level of Service	C
HCM 2000 Volume to Capacity ratio	0.61		
Actuated Cycle Length (s)	104.7	Sum of lost time (s)	25.0
Intersection Capacity Utilization	78.0%	ICU Level of Service	D
Analysis Period (min)	15		

c Critical Lane Group

HCM Unsignalized Intersection Capacity Analysis

18: CO 83 & Walden Way

09/01/2021



Movement	WBL	WBR	NBT	NBR	SBL	SBT
Lane Configurations						
Traffic Volume (veh/h)	2	9	380	5	9	567
Future Volume (Veh/h)	2	9	380	5	9	567
Sign Control	Stop		Free		Free	
Grade	0%		0%		0%	
Peak Hour Factor	0.75	0.75	0.76	0.76	0.93	0.93
Hourly flow rate (vph)	3	12	500	7	10	610
Pedestrians						
Lane Width (ft)						
Walking Speed (ft/s)						
Percent Blockage						
Right turn flare (veh)						
Median type	None			None		
Median storage (veh)						
Upstream signal (ft)						
pX, platoon unblocked						
vC, conflicting volume	1134	504			507	
vC1, stage 1 conf vol						
vC2, stage 2 conf vol						
vCu, unblocked vol	1134	504			507	
tC, single (s)	6.5	6.3			4.2	
tC, 2 stage (s)						
tF (s)	3.6	3.4			2.3	
p0 queue free %	99	98			99	
cM capacity (veh/h)	211	547			1004	
Direction, Lane #	WB 1	NB 1	SB 1			
Volume Total	15	507	620			
Volume Left	3	0	10			
Volume Right	12	7	0			
cSH	415	1700	1004			
Volume to Capacity	0.04	0.30	0.01			
Queue Length 95th (ft)	3	0	1			
Control Delay (s)	14.0	0.0	0.3			
Lane LOS	B		A			
Approach Delay (s)	14.0	0.0	0.3			
Approach LOS	B					
Intersection Summary						
Average Delay			0.3			
Intersection Capacity Utilization			47.0%	ICU Level of Service	A	
Analysis Period (min)			15			

HCM Signalized Intersection Capacity Analysis
 19: CO 83 & CR 105/Walker Rd

09/01/2021

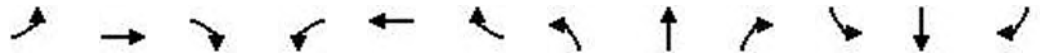

Movement	EBL	EBT	EBR	WBL	WBT	WBR	NBL	NBT	NBR	SBL	SBT	SBR
Lane Configurations		↕	↗		↕	↗	↗	↑	↗	↗	↑	↗
Traffic Volume (vph)	129	57	47	25	50	10	127	219	35	10	430	65
Future Volume (vph)	129	57	47	25	50	10	127	219	35	10	430	65
Ideal Flow (vphpl)	1900	1900	1900	1900	1900	1900	1900	1900	1900	1900	1900	1900
Total Lost time (s)		6.0	4.0		6.0	6.0	5.0	7.0	7.0	5.0	7.0	7.0
Lane Util. Factor		1.00	1.00		1.00	1.00	1.00	1.00	1.00	1.00	1.00	1.00
Frt		1.00	0.85		1.00	0.85	1.00	1.00	0.85	1.00	1.00	0.85
Flt Protected		0.97	1.00		0.98	1.00	0.95	1.00	1.00	0.95	1.00	1.00
Satd. Flow (prot)		1625	1429		1654	1429	1597	1681	1429	1597	1681	1429
Flt Permitted		0.72	1.00		0.81	1.00	0.34	1.00	1.00	0.59	1.00	1.00
Satd. Flow (perm)		1207	1429		1364	1429	575	1681	1429	1000	1681	1429
Peak-hour factor, PHF	0.94	0.94	0.94	0.61	0.61	0.61	0.82	0.82	0.82	0.95	0.95	0.95
Adj. Flow (vph)	137	61	50	41	82	16	155	267	43	11	453	68
RTOR Reduction (vph)	0	0	0	0	0	13	0	0	19	0	0	38
Lane Group Flow (vph)	0	198	50	0	123	3	155	267	24	11	453	30
Turn Type	Perm	NA	Free	Perm	NA	Perm	pm+pt	NA	Perm	pm+pt	NA	Perm
Protected Phases		4			8		5	2		1	6	
Permitted Phases	4		Free	8		8	2		2	6		6
Actuated Green, G (s)		17.2	81.5		17.2	17.2	51.3	45.3	45.3	37.4	36.4	36.4
Effective Green, g (s)		17.2	81.5		17.2	17.2	51.3	45.3	45.3	37.4	36.4	36.4
Actuated g/C Ratio		0.21	1.00		0.21	0.21	0.63	0.56	0.56	0.46	0.45	0.45
Clearance Time (s)		6.0			6.0	6.0	5.0	7.0	7.0	5.0	7.0	7.0
Vehicle Extension (s)		3.0			3.0	3.0	3.0	3.0	3.0	3.0	3.0	3.0
Lane Grp Cap (vph)		254	1429		287	301	486	934	794	466	750	638
v/s Ratio Prot							c0.04	0.16		0.00	c0.27	
v/s Ratio Perm		c0.16	0.03		0.09	0.00	0.16		0.02	0.01		0.02
v/c Ratio		0.78	0.03		0.43	0.01	0.32	0.29	0.03	0.02	0.60	0.05
Uniform Delay, d1		30.4	0.0		27.9	25.4	7.5	9.6	8.2	12.0	17.1	12.7
Progression Factor		1.00	1.00		1.00	1.00	1.00	1.00	1.00	1.00	1.00	1.00
Incremental Delay, d2		14.0	0.0		1.0	0.0	0.4	0.2	0.0	0.0	1.4	0.0
Delay (s)		44.4	0.0		28.9	25.4	7.9	9.7	8.2	12.0	18.5	12.8
Level of Service		D	A		C	C	A	A	A	B	B	B
Approach Delay (s)		35.4			28.5			9.0			17.6	
Approach LOS		D			C			A			B	

Intersection Summary

HCM 2000 Control Delay	19.0	HCM 2000 Level of Service	B
HCM 2000 Volume to Capacity ratio	0.61		
Actuated Cycle Length (s)	81.5	Sum of lost time (s)	18.0
Intersection Capacity Utilization	63.8%	ICU Level of Service	B
Analysis Period (min)	15		

c Critical Lane Group

HCM Signalized Intersection Capacity Analysis

20: CO 83 & E Palmer Divide Ave

09/01/2021



Movement	EBL	EBT	EBR	WBL	WBT	WBR	NBL	NBT	NBR	SBL	SBT	SBR
Lane Configurations		↔			↔		↗	↖		↗	↖	
Traffic Volume (vph)	21	30	64	33	17	4	36	199	70	13	373	42
Future Volume (vph)	21	30	64	33	17	4	36	199	70	13	373	42
Ideal Flow (vphpl)	1900	1900	1900	1900	1900	1900	1900	1900	1900	1900	1900	1900
Total Lost time (s)		7.0			7.0		8.0	8.0		8.0	8.0	
Lane Util. Factor		1.00			1.00		1.00	1.00		1.00	1.00	
Frt		0.92			0.99		1.00	0.96		1.00	0.98	
Flt Protected		0.99			0.97		0.95	1.00		0.95	1.00	
Satd. Flow (prot)		1541			1616		1597	1616		1597	1656	
Flt Permitted		0.92			0.74		0.51	1.00		0.55	1.00	
Satd. Flow (perm)		1429			1230		852	1616		931	1656	
Peak-hour factor, PHF	0.88	0.88	0.88	0.78	0.78	0.78	0.78	0.78	0.78	0.94	0.94	0.94
Adj. Flow (vph)	24	34	73	42	22	5	46	255	90	14	397	45
RTOR Reduction (vph)	0	52	0	0	3	0	0	15	0	0	5	0
Lane Group Flow (vph)	0	79	0	0	66	0	46	330	0	14	437	0
Turn Type	Perm	NA		Perm	NA		Perm	NA		Perm	NA	
Protected Phases		4			8			2			6	
Permitted Phases	4			8			2			6		
Actuated Green, G (s)		7.8			7.8		20.5	20.5		20.5	20.5	
Effective Green, g (s)		7.8			7.8		20.5	20.5		20.5	20.5	
Actuated g/C Ratio		0.18			0.18		0.47	0.47		0.47	0.47	
Clearance Time (s)		7.0			7.0		8.0	8.0		8.0	8.0	
Vehicle Extension (s)		5.0			5.0		5.0	5.0		5.0	5.0	
Lane Grp Cap (vph)		257			221		403	765		440	784	
v/s Ratio Prot								0.20			c0.26	
v/s Ratio Perm		c0.05			0.05		0.05			0.02		
v/c Ratio		0.31			0.30		0.11	0.43		0.03	0.56	
Uniform Delay, d1		15.4			15.4		6.3	7.5		6.1	8.2	
Progression Factor		1.00			1.00		1.00	1.00		1.00	1.00	
Incremental Delay, d2		1.4			1.6		0.3	0.8		0.1	1.5	
Delay (s)		16.8			17.0		6.6	8.4		6.2	9.6	
Level of Service		B			B		A	A		A	A	
Approach Delay (s)		16.8			17.0			8.2			9.5	
Approach LOS		B			B			A			A	

Intersection Summary

HCM 2000 Control Delay	10.4	HCM 2000 Level of Service	B
HCM 2000 Volume to Capacity ratio	0.49		
Actuated Cycle Length (s)	43.3	Sum of lost time (s)	15.0
Intersection Capacity Utilization	50.3%	ICU Level of Service	A
Analysis Period (min)	15		

c Critical Lane Group

D.2. 2045 No-Action

HCM Signalized Intersection Capacity Analysis

1: CO 83 & SO 21 SB

09/01/2021



Movement	SEL	SET	SER	NWL	NWT	NWR	NEL	NET	NER	SWL	SWT	SWR
Lane Configurations	↕↕		↕					↕↕↕	↕	↕↕	↕↕↕	
Traffic Volume (vph)	425	0	685	0	0	0	0	415	525	700	895	0
Future Volume (vph)	425	0	685	0	0	0	0	415	525	700	895	0
Ideal Flow (vphpl)	1900	1900	1900	1900	1900	1900	1900	1900	1900	1900	1900	1900
Total Lost time (s)	4.5		4.5					7.5	4.0	5.0	7.5	
Lane Util. Factor	0.97		1.00					0.91	1.00	0.97	0.91	
Frt	1.00		0.85					1.00	0.85	1.00	1.00	
Flt Protected	0.95		1.00					1.00	1.00	0.95	1.00	
Satd. Flow (prot)	3099		1429					4590	1429	3099	4590	
Flt Permitted	0.95		1.00					1.00	1.00	0.32	1.00	
Satd. Flow (perm)	3099		1429					4590	1429	1055	4590	
Peak-hour factor, PHF	0.92	0.92	0.92	0.92	0.92	0.92	0.92	0.86	0.86	0.91	0.91	0.92
Adj. Flow (vph)	462	0	745	0	0	0	0	483	610	769	984	0
RTOR Reduction (vph)	0	0	42	0	0	0	0	0	0	0	0	0
Lane Group Flow (vph)	462	0	703	0	0	0	0	483	610	769	984	0
Turn Type	Prot		Perm					NA	Free	pm+pt	NA	
Protected Phases	4							2		1	6	
Permitted Phases	4		4						Free	6		
Actuated Green, G (s)	62.2		62.2					22.8	124.0	49.8	49.8	
Effective Green, g (s)	62.2		62.2					22.8	124.0	49.8	49.8	
Actuated g/C Ratio	0.50		0.50					0.18	1.00	0.40	0.40	
Clearance Time (s)	4.5		4.5					7.5		5.0	7.5	
Vehicle Extension (s)	3.0		3.0					1.0		3.0	1.0	
Lane Grp Cap (vph)	1554		716					843	1429	786	1843	
v/s Ratio Prot	0.15							0.11		c0.17	0.21	
v/s Ratio Perm			c0.49						0.43	c0.22		
v/c Ratio	0.30		0.98					0.57	0.43	0.98	0.53	
Uniform Delay, d1	18.1		30.4					46.2	0.0	31.3	28.3	
Progression Factor	1.00		1.00					1.00	1.00	1.00	1.00	
Incremental Delay, d2	0.1		29.0					2.8	0.9	26.5	1.1	
Delay (s)	18.2		59.4					49.0	0.9	57.8	29.4	
Level of Service	B		E					D	A	E	C	
Approach Delay (s)		43.6			0.0			22.2			41.9	
Approach LOS		D			A			C			D	

Intersection Summary

HCM 2000 Control Delay	37.1	HCM 2000 Level of Service	D
HCM 2000 Volume to Capacity ratio	1.01		
Actuated Cycle Length (s)	124.0	Sum of lost time (s)	17.0
Intersection Capacity Utilization	71.2%	ICU Level of Service	C
Analysis Period (min)	15		

c Critical Lane Group

HCM Signalized Intersection Capacity Analysis
 2: CO 83 & CO 21 NB

09/01/2021



Movement	SEL	SET	SER	NWL	NWT	NWR	NEL	NET	NER	SWL	SWT	SWR
Lane Configurations				↔↔		↗	↔↔	↕↕↕			↕↕↕	↗
Traffic Volume (vph)	0	0	0	815	0	330	300	540	0	0	780	400
Future Volume (vph)	0	0	0	815	0	330	300	540	0	0	780	400
Ideal Flow (vphpl)	1900	1900	1900	1900	1900	1900	1900	1900	1900	1900	1900	1900
Total Lost time (s)				6.5		4.0	4.5	7.5			6.5	6.5
Lane Util. Factor				0.97		1.00	0.97	0.91			0.91	1.00
Frt				1.00		0.85	1.00	1.00			1.00	0.85
Flt Protected				0.95		1.00	0.95	1.00			1.00	1.00
Satd. Flow (prot)				3099		1429	3099	4590			4590	1429
Flt Permitted				0.95		1.00	0.95	1.00			1.00	1.00
Satd. Flow (perm)				3099		1429	3099	4590			4590	1429
Peak-hour factor, PHF	0.92	0.92	0.92	0.88	0.92	0.88	0.92	0.69	0.69	0.90	0.90	0.92
Adj. Flow (vph)	0	0	0	926	0	375	326	783	0	0	867	435
RTOR Reduction (vph)	0	0	0	0	0	0	0	0	0	0	0	273
Lane Group Flow (vph)	0	0	0	926	0	375	326	783	0	0	867	162
Turn Type				Prot		Free	Prot	NA			NA	Perm
Protected Phases				4			5	2			6	
Permitted Phases				4		Free						6
Actuated Green, G (s)				40.7		120.0	17.2	65.3			44.6	44.6
Effective Green, g (s)				40.7		120.0	17.2	65.3			44.6	44.6
Actuated g/C Ratio				0.34		1.00	0.14	0.54			0.37	0.37
Clearance Time (s)				6.5			4.5	7.5			6.5	6.5
Vehicle Extension (s)				2.0			3.0	1.0			1.0	1.0
Lane Grp Cap (vph)				1051		1429	444	2497			1705	531
v/s Ratio Prot				c0.30			c0.11	0.17			c0.19	
v/s Ratio Perm						0.26						0.11
v/c Ratio				0.88		0.26	0.73	0.31			0.51	0.30
Uniform Delay, d1				37.4		0.0	49.2	15.0			29.2	26.7
Progression Factor				1.00		1.00	1.00	1.00			1.00	1.00
Incremental Delay, d2				8.6		0.4	6.2	0.3			1.1	1.5
Delay (s)				45.9		0.4	55.4	15.4			30.3	28.2
Level of Service				D		A	E	B			C	C
Approach Delay (s)		0.0			32.8			27.1			29.6	
Approach LOS		A			C			C			C	

Intersection Summary

HCM 2000 Control Delay	30.0	HCM 2000 Level of Service	C
HCM 2000 Volume to Capacity ratio	0.69		
Actuated Cycle Length (s)	120.0	Sum of lost time (s)	17.5
Intersection Capacity Utilization	71.2%	ICU Level of Service	C
Analysis Period (min)	15		

c Critical Lane Group

Intersection has too many lanes per leg.

HCM All-Way analysis is limited to two lanes per leg.

Channelized right turn lanes are not counted.

HCM Signalized Intersection Capacity Analysis

4: CO 83 & Shoup Road

09/01/2021



Movement	NBT	NBR	SBL	SBT	SWL	SWR
Lane Configurations	↑↑↑	↑	↙	↑↑↑	↙	↗
Traffic Volume (vph)	750	365	245	915	365	240
Future Volume (vph)	750	365	245	915	365	240
Ideal Flow (vphpl)	1900	1900	1900	1900	1900	1900
Total Lost time (s)	7.5	4.0	5.0	7.5	6.0	4.0
Lane Util. Factor	0.91	1.00	1.00	0.91	1.00	1.00
Frt	1.00	0.85	1.00	1.00	1.00	0.85
Flt Protected	1.00	1.00	0.95	1.00	0.95	1.00
Satd. Flow (prot)	4590	1429	1597	4590	1597	1429
Flt Permitted	1.00	1.00	0.23	1.00	0.95	1.00
Satd. Flow (perm)	4590	1429	393	4590	1597	1429
Peak-hour factor, PHF	0.87	0.87	0.86	0.86	0.82	0.82
Adj. Flow (vph)	862	420	285	1064	445	293
RTOR Reduction (vph)	0	0	0	0	0	0
Lane Group Flow (vph)	862	420	285	1064	445	293
Turn Type	NA	Free	pm+pt	NA	Prot	Free
Protected Phases	2		1	6	8	
Permitted Phases		Free	6			Free
Actuated Green, G (s)	38.5	103.7	57.3	57.3	32.9	103.7
Effective Green, g (s)	38.5	103.7	57.3	57.3	32.9	103.7
Actuated g/C Ratio	0.37	1.00	0.55	0.55	0.32	1.00
Clearance Time (s)	7.5		5.0	7.5	6.0	
Vehicle Extension (s)	1.0		1.0	1.0	3.0	
Lane Grp Cap (vph)	1704	1429	377	2536	506	1429
v/s Ratio Prot	0.19		c0.10	0.23	c0.28	
v/s Ratio Perm		0.29	c0.32			0.21
v/c Ratio	0.51	0.29	0.76	0.42	0.88	0.21
Uniform Delay, d1	25.2	0.0	14.0	13.5	33.5	0.0
Progression Factor	1.00	1.00	1.00	1.00	1.00	1.00
Incremental Delay, d2	1.1	0.5	7.5	0.5	15.9	0.3
Delay (s)	26.3	0.5	21.5	14.0	49.4	0.3
Level of Service	C	A	C	B	D	A
Approach Delay (s)	17.9			15.6	29.9	
Approach LOS	B			B	C	

Intersection Summary

HCM 2000 Control Delay	19.6	HCM 2000 Level of Service	B
HCM 2000 Volume to Capacity ratio	0.83		
Actuated Cycle Length (s)	103.7	Sum of lost time (s)	18.5
Intersection Capacity Utilization	65.9%	ICU Level of Service	C
Analysis Period (min)	15		

c Critical Lane Group

HCM Signalized Intersection Capacity Analysis

5: CO 83 & Flying Horse Club Dr/Abert Way

09/01/2021



Movement	EBL	EBT	EBR	WBL	WBT	WBR	NBL	NBT	NBR	SBL	SBT	SBR
Lane Configurations												
Traffic Volume (vph)	155	0	290	10	5	5	255	735	5	5	890	140
Future Volume (vph)	155	0	290	10	5	5	255	735	5	5	890	140
Ideal Flow (vphpl)	1900	1900	1900	1900	1900	1900	1900	1900	1900	1900	1900	1900
Total Lost time (s)	7.0		7.0	7.0	7.0		7.0	8.0		7.0	8.0	8.0
Lane Util. Factor	1.00		1.00	1.00	1.00		1.00	0.91		1.00	0.91	1.00
Frpb, ped/bikes	1.00		1.00	1.00	1.00		1.00	1.00		1.00	1.00	1.00
Flpb, ped/bikes	1.00		1.00	1.00	1.00		1.00	1.00		1.00	1.00	1.00
Frt	1.00		0.85	1.00	0.93		1.00	1.00		1.00	1.00	0.85
Flt Protected	0.95		1.00	0.95	1.00		0.95	1.00		0.95	1.00	1.00
Satd. Flow (prot)	1597		1429	1597	1555		1597	4584		1596	4590	1429
Flt Permitted	0.74		1.00	0.76	1.00		0.17	1.00		0.33	1.00	1.00
Satd. Flow (perm)	1249		1429	1273	1555		288	4584		553	4590	1429
Peak-hour factor, PHF	0.75	0.75	0.75	0.44	0.44	0.44	0.90	0.90	0.90	0.83	0.83	0.83
Adj. Flow (vph)	207	0	387	23	11	11	283	817	6	6	1072	169
RTOR Reduction (vph)	0	0	287	0	9	0	0	0	0	0	0	100
Lane Group Flow (vph)	207	0	100	23	13	0	283	823	0	6	1072	69
Confl. Peds. (#/hr)									6	6		
Turn Type	Perm		Perm	Perm	NA		pm+pt	NA		pm+pt	NA	Perm
Protected Phases		4			8		5	2		1	6	
Permitted Phases	4		4	8			2			6		6
Actuated Green, G (s)	21.2		21.2	21.2	21.2		68.7	60.9		43.6	42.8	42.8
Effective Green, g (s)	21.2		21.2	21.2	21.2		68.7	60.9		43.6	42.8	42.8
Actuated g/C Ratio	0.20		0.20	0.20	0.20		0.65	0.58		0.42	0.41	0.41
Clearance Time (s)	7.0		7.0	7.0	7.0		7.0	8.0		7.0	8.0	8.0
Vehicle Extension (s)	3.0		3.0	3.0	3.0		3.0	3.0		3.0	3.0	3.0
Lane Grp Cap (vph)	252		288	257	314		424	2661		237	1872	583
v/s Ratio Prot					0.01		c0.12	0.18		0.00	0.23	
v/s Ratio Perm	c0.17		0.07	0.02			c0.32			0.01		0.05
v/c Ratio	0.82		0.35	0.09	0.04		0.67	0.31		0.03	0.57	0.12
Uniform Delay, d1	40.0		35.9	34.0	33.7		11.3	11.2		18.0	24.0	19.3
Progression Factor	1.00		1.00	1.00	1.00		1.00	1.00		1.00	1.00	1.00
Incremental Delay, d2	18.9		0.7	0.2	0.1		4.0	0.1		0.0	0.4	0.1
Delay (s)	59.0		36.6	34.2	33.7		15.3	11.3		18.0	24.4	19.4
Level of Service	E		D	C	C		B	B		B	C	B
Approach Delay (s)		44.4			34.0			12.3			23.7	
Approach LOS		D			C			B			C	





















Intersection Summary

HCM 2000 Control Delay	23.8	HCM 2000 Level of Service	C
HCM 2000 Volume to Capacity ratio	0.73		
Actuated Cycle Length (s)	104.9	Sum of lost time (s)	22.0
Intersection Capacity Utilization	76.9%	ICU Level of Service	D
Analysis Period (min)	15		
c Critical Lane Group			

HCM Signalized Intersection Capacity Analysis

6: CO 83 & North Gate Blvd

09/01/2021

												
Movement	EBL	EBT	EBR	WBL	WBT	WBR	NBL	NBT	NBR	SBL	SBT	SBR
Lane Configurations												
Traffic Volume (vph)	60	5	325	20	5	10	550	350	1	5	750	115
Future Volume (vph)	60	5	325	20	5	10	550	350	1	5	750	115
Ideal Flow (vphpl)	1900	1900	1900	1900	1900	1900	1900	1900	1900	1900	1900	1900
Total Lost time (s)	6.0	6.0	6.0		6.0		5.0	7.0		7.0	7.0	7.0
Lane Util. Factor	1.00	1.00	1.00		1.00		0.97	0.95		1.00	0.95	1.00
Frbp, ped/bikes	1.00	1.00	1.00		1.00		1.00	1.00		1.00	1.00	1.00
Flpb, ped/bikes	1.00	1.00	1.00		1.00		1.00	1.00		1.00	1.00	1.00
Frt	1.00	1.00	0.85		0.96		1.00	1.00		1.00	1.00	0.85
Flt Protected	0.95	1.00	1.00		0.97		0.95	1.00		0.95	1.00	1.00
Satd. Flow (prot)	1438	1513	1286		1414		2789	2874		1433	2875	1286
Flt Permitted	0.63	1.00	1.00		0.82		0.95	1.00		0.51	1.00	1.00
Satd. Flow (perm)	952	1513	1286		1193		2789	2874		777	2875	1286
Peak-hour factor, PHF	0.84	0.84	0.84	0.25	0.25	0.25	0.87	0.87	0.87	0.89	0.89	0.89
Adj. Flow (vph)	71	6	387	80	20	40	632	402	1	6	843	129
RTOR Reduction (vph)	0	0	331	0	10	0	0	0	0	0	0	69
Lane Group Flow (vph)	71	6	56	0	130	0	632	403	0	6	843	60
Confl. Peds. (#/hr)									3	3		
Turn Type	Perm	NA	Perm	Perm	NA		Prot	NA		Perm	NA	Perm
Protected Phases		4			8		5	2			6	
Permitted Phases	4		4	8						6		6
Actuated Green, G (s)	19.9	19.9	19.9		19.9		35.6	105.2		64.6	64.6	64.6
Effective Green, g (s)	19.9	19.9	19.9		19.9		35.6	105.2		64.6	64.6	64.6
Actuated g/C Ratio	0.14	0.14	0.14		0.14		0.26	0.76		0.47	0.47	0.47
Clearance Time (s)	6.0	6.0	6.0		6.0		5.0	7.0		7.0	7.0	7.0
Vehicle Extension (s)	3.0	3.0	3.0		3.0		3.0	3.0		3.0	3.0	3.0
Lane Grp Cap (vph)	137	218	185		171		718	2189		363	1344	601
v/s Ratio Prot		0.00					c0.23	0.14			c0.29	
v/s Ratio Perm	0.07		0.04		c0.11					0.01		0.05
v/c Ratio	0.52	0.03	0.30		0.76		0.88	0.18		0.02	0.63	0.10
Uniform Delay, d1	54.7	50.8	52.9		56.8		49.2	4.6		19.7	27.7	20.5
Progression Factor	1.00	1.00	1.00		1.00		1.00	1.00		1.00	1.00	1.00
Incremental Delay, d2	3.3	0.1	0.9		17.4		12.1	0.2		0.1	2.2	0.3
Delay (s)	58.0	50.8	53.8		74.2		61.4	4.7		19.8	29.9	20.9
Level of Service	E	D	D		E		E	A		B	C	C
Approach Delay (s)		54.4			74.2			39.3			28.6	
Approach LOS		D			E			D			C	
Intersection Summary												
HCM 2000 Control Delay			39.9				HCM 2000 Level of Service				D	
HCM 2000 Volume to Capacity ratio			0.72									
Actuated Cycle Length (s)			138.1				Sum of lost time (s)			18.0		
Intersection Capacity Utilization			66.2%				ICU Level of Service			C		
Analysis Period (min)			15									
c Critical Lane Group												

HCM Unsignalized Intersection Capacity Analysis

7: CO 83

09/01/2021



Movement	WBL	WBR	NBT	NBR	SBL	SBT
Lane Configurations	↔		↕↕		↔	↕↕
Traffic Volume (veh/h)	1	5	550	10	1	965
Future Volume (Veh/h)	1	5	550	10	1	965
Sign Control	Stop		Free		Free	Free
Grade	0%		0%		0%	0%
Peak Hour Factor	0.75	0.75	0.86	0.86	0.92	0.92
Hourly flow rate (vph)	1	7	640	12	1	1049
Pedestrians						
Lane Width (ft)						
Walking Speed (ft/s)						
Percent Blockage						
Right turn flare (veh)						
Median type	None			None		
Median storage (veh)						
Upstream signal (ft)						
pX, platoon unblocked						
vC, conflicting volume	1172	326			652	
vC1, stage 1 conf vol						
vC2, stage 2 conf vol						
vCu, unblocked vol	1172	326			652	
tC, single (s)	7.1	7.2			4.4	
tC, 2 stage (s)						
tF (s)	3.6	3.4			2.3	
p0 queue free %	99	99			100	
cM capacity (veh/h)	169	638			860	
Direction, Lane #	WB 1	NB 1	NB 2	SB 1	SB 2	SB 3
Volume Total	8	427	225	1	524	524
Volume Left	1	0	0	1	0	0
Volume Right	7	0	12	0	0	0
cSH	474	1700	1700	860	1700	1700
Volume to Capacity	0.02	0.25	0.13	0.00	0.31	0.31
Queue Length 95th (ft)	1	0	0	0	0	0
Control Delay (s)	12.7	0.0	0.0	9.2	0.0	0.0
Lane LOS	B			A		
Approach Delay (s)	12.7	0.0		0.0		
Approach LOS	B					
Intersection Summary						
Average Delay			0.1			
Intersection Capacity Utilization			36.7%	ICU Level of Service	A	
Analysis Period (min)			15			

HCM Unsignalized Intersection Capacity Analysis

8: CO 83 & Old North Gate Rd

09/01/2021



Movement	EBL	EBR	NBL	NBT	SBT	SBR
Lane Configurations						
Traffic Volume (veh/h)	10	210	90	465	755	21
Future Volume (Veh/h)	10	210	90	465	755	21
Sign Control	Stop			Free	Free	
Grade	0%			0%	0%	
Peak Hour Factor	0.76	0.76	0.87	0.87	0.91	0.91
Hourly flow rate (vph)	13	276	103	534	830	23
Pedestrians						
Lane Width (ft)						
Walking Speed (ft/s)						
Percent Blockage						
Right turn flare (veh)	2					
Median type				None	None	
Median storage (veh)						
Upstream signal (ft)						
pX, platoon unblocked						
vC, conflicting volume	1314	426	853			
vC1, stage 1 conf vol						
vC2, stage 2 conf vol						
vCu, unblocked vol	1314	426	853			
tC, single (s)	7.1	7.2	4.4			
tC, 2 stage (s)						
tF (s)	3.6	3.4	2.3			
p0 queue free %	89	50	86			
cM capacity (veh/h)	116	547	716			
Direction, Lane #	EB 1	NB 1	NB 2	NB 3	SB 1	SB 2
Volume Total	289	103	267	267	553	300
Volume Left	13	103	0	0	0	0
Volume Right	276	0	0	0	0	23
cSH	573	716	1700	1700	1700	1700
Volume to Capacity	0.50	0.14	0.16	0.16	0.33	0.18
Queue Length 95th (ft)	71	13	0	0	0	0
Control Delay (s)	19.1	10.9	0.0	0.0	0.0	0.0
Lane LOS	C	B				
Approach Delay (s)	19.1	1.8	0.0			
Approach LOS	C					
Intersection Summary						
Average Delay			3.7			
Intersection Capacity Utilization			41.2%	ICU Level of Service	A	
Analysis Period (min)			15			

Intersection Sign configuration not allowed in HCM analysis.

HCM Unsignalized Intersection Capacity Analysis
 10: Shamrock Ranch Rd & CO 83

09/01/2021



Movement	EBT	EBR	WBL	WBT	NWL	NWR
Lane Configurations	↑↑			↑↑	↑↑	
Traffic Volume (veh/h)	470	0	0	795	25	20
Future Volume (Veh/h)	470	0	0	795	25	20
Sign Control	Free			Free	Stop	
Grade	0%			0%	0%	
Peak Hour Factor	0.85	0.85	0.90	0.90	0.92	0.92
Hourly flow rate (vph)	553	0	0	883	27	22
Pedestrians						
Lane Width (ft)						
Walking Speed (ft/s)						
Percent Blockage						
Right turn flare (veh)						
Median type	None			None		
Median storage (veh)						
Upstream signal (ft)						
pX, platoon unblocked						
vC, conflicting volume			553		994	276
vC1, stage 1 conf vol						
vC2, stage 2 conf vol						
vCu, unblocked vol			553		994	276
tC, single (s)			4.4		7.1	7.2
tC, 2 stage (s)						
tF (s)			2.3		3.6	3.4
p0 queue free %			100		88	97
cM capacity (veh/h)			941		223	689
Direction, Lane #	EB 1	EB 2	WB 1	WB 2	NW 1	
Volume Total	369	184	294	589	49	
Volume Left	0	0	0	0	27	
Volume Right	0	0	0	0	22	
cSH	1700	1700	941	1700	321	
Volume to Capacity	0.22	0.11	0.00	0.35	0.15	
Queue Length 95th (ft)	0	0	0	0	13	
Control Delay (s)	0.0	0.0	0.0	0.0	18.2	
Lane LOS						C
Approach Delay (s)	0.0		0.0		18.2	
Approach LOS						C
Intersection Summary						
Average Delay			0.6			
Intersection Capacity Utilization			32.0%	ICU Level of Service	A	
Analysis Period (min)			15			

HCM Unsignalized Intersection Capacity Analysis

11: CO 83 & Kaessner Lane





















09/01/2021



Movement	EBL	EBR	NBL	NBT	SBT	SBR
Lane Configurations						
Traffic Volume (veh/h)	0	10	5	460	795	1
Future Volume (Veh/h)	0	10	5	460	795	1
Sign Control	Stop			Free	Free	
Grade	0%			0%	0%	
Peak Hour Factor	0.50	0.50	0.87	0.87	0.92	0.92
Hourly flow rate (vph)	0	20	6	529	864	1
Pedestrians						
Lane Width (ft)						
Walking Speed (ft/s)						
Percent Blockage						
Right turn flare (veh)						
Median type				None	None	
Median storage (veh)						
Upstream signal (ft)						
pX, platoon unblocked						
vC, conflicting volume	1141	432	865			
vC1, stage 1 conf vol						
vC2, stage 2 conf vol						
vCu, unblocked vol	1141	432	865			
tC, single (s)	7.1	7.2	4.4			
tC, 2 stage (s)						
tF (s)	3.6	3.4	2.3			
p0 queue free %	100	96	99			
cM capacity (veh/h)	177	542	708			
Direction, Lane #	EB 1	NB 1	NB 2	SB 1	SB 2	
Volume Total	20	182	353	576	289	
Volume Left	0	6	0	0	0	
Volume Right	20	0	0	0	1	
cSH	542	708	1700	1700	1700	
Volume to Capacity	0.04	0.01	0.21	0.34	0.17	
Queue Length 95th (ft)	3	1	0	0	0	
Control Delay (s)	11.9	0.4	0.0	0.0	0.0	
Lane LOS	B	A				
Approach Delay (s)	11.9	0.1		0.0		
Approach LOS	B					
Intersection Summary						
Average Delay	0.2					
Intersection Capacity Utilization	32.0%			ICU Level of Service	A	
Analysis Period (min)	15					

HCM Signalized Intersection Capacity Analysis
 12: CO 83 & Stagecoach Rd

09/01/2021

												
Movement	EBL	EBT	EBR	WBL	WBT	WBR	NBL	NBT	NBR	SBL	SBT	SBR
Lane Configurations												
Traffic Volume (vph)	0	1	10	90	5	55	1	395	55	25	750	0
Future Volume (vph)	0	1	10	90	5	55	1	395	55	25	750	0
Ideal Flow (vphpl)	1900	1900	1900	1900	1900	1900	1900	1900	1900	1900	1900	1900
Total Lost time (s)		4.5			4.5	4.5	4.5	4.5	4.5	4.5	4.5	
Lane Util. Factor		1.00			1.00	1.00	1.00	0.95	1.00	1.00	0.95	
Frt		0.88			1.00	0.85	1.00	1.00	0.85	1.00	1.00	
Flt Protected		1.00			0.95	1.00	0.95	1.00	1.00	0.95	1.00	
Satd. Flow (prot)		1478			1605	1429	1597	3195	1429	1597	3195	
Flt Permitted		1.00			0.72	1.00	0.34	1.00	1.00	0.40	1.00	
Satd. Flow (perm)		1478			1217	1429	574	3195	1429	665	3195	
Peak-hour factor, PHF	0.58	0.58	0.58	0.72	0.72	0.72	0.85	0.85	0.85	0.91	0.91	0.91
Adj. Flow (vph)	0	2	17	125	7	76	1	465	65	27	824	0
RTOR Reduction (vph)	0	13	0	0	0	58	0	0	36	0	0	0
Lane Group Flow (vph)	0	6	0	0	132	18	1	465	29	27	824	0
Turn Type		NA		Perm	NA	Perm	Perm	NA	Perm	pm+pt	NA	
Protected Phases		4			8			2		1	6	
Permitted Phases	4			8		8	2		2	6		
Actuated Green, G (s)		10.6			10.6	10.6	19.9	19.9	19.9	25.5	25.5	
Effective Green, g (s)		10.6			10.6	10.6	19.9	19.9	19.9	25.5	25.5	
Actuated g/C Ratio		0.24			0.24	0.24	0.44	0.44	0.44	0.57	0.57	
Clearance Time (s)		4.5			4.5	4.5	4.5	4.5	4.5	4.5	4.5	
Vehicle Extension (s)		3.0			3.0	3.0	3.0	3.0	3.0	3.0	3.0	
Lane Grp Cap (vph)		347			286	335	253	1409	630	398	1806	
v/s Ratio Prot		0.00						0.15		0.00	c0.26	
v/s Ratio Perm					c0.11	0.01	0.00		0.02	0.04		
v/c Ratio		0.02			0.46	0.05	0.00	0.33	0.05	0.07	0.46	
Uniform Delay, d1		13.2			14.8	13.4	7.1	8.2	7.2	4.6	5.7	
Progression Factor		1.00			1.00	1.00	1.00	1.00	1.00	1.00	1.00	
Incremental Delay, d2		0.0			1.2	0.1	0.0	0.1	0.0	0.1	0.2	
Delay (s)		13.3			16.0	13.4	7.1	8.4	7.2	4.6	5.9	
Level of Service		B			B	B	A	A	A	A	A	
Approach Delay (s)		13.3			15.0			8.2		5.9		
Approach LOS		B			B			A		A		
Intersection Summary												
HCM 2000 Control Delay			7.9		HCM 2000 Level of Service					A		
HCM 2000 Volume to Capacity ratio			0.52									
Actuated Cycle Length (s)			45.1		Sum of lost time (s)				13.5			
Intersection Capacity Utilization			40.2%		ICU Level of Service				A			
Analysis Period (min)			15									

c Critical Lane Group

HCM Unsignalized Intersection Capacity Analysis

13: CO 83 & Private Access

09/01/2021



Movement	EBL	EBR	NBL	NBT	SBT	SBR
Lane Configurations						
Traffic Volume (veh/h)	5	5	5	420	770	5
Future Volume (Veh/h)	5	5	5	420	770	5
Sign Control	Stop			Free	Free	
Grade	0%			0%	0%	
Peak Hour Factor	1.00	1.00	0.87	0.87	0.92	0.92
Hourly flow rate (vph)	5	5	6	483	837	5
Pedestrians						
Lane Width (ft)						
Walking Speed (ft/s)						
Percent Blockage						
Right turn flare (veh)						
Median type				None	None	
Median storage (veh)						
Upstream signal (ft)	1248					
pX, platoon unblocked						
vC, conflicting volume	1093	421	842			
vC1, stage 1 conf vol						
vC2, stage 2 conf vol						
vCu, unblocked vol	1093	421	842			
tC, single (s)	7.1	7.2	4.4			
tC, 2 stage (s)						
tF (s)	3.6	3.4	2.3			
p0 queue free %	97	99	99			
cM capacity (veh/h)	190	552	723			
Direction, Lane #	EB 1	NB 1	NB 2	SB 1	SB 2	
Volume Total	10	167	322	558	284	
Volume Left	5	6	0	0	0	
Volume Right	5	0	0	0	5	
cSH	283	723	1700	1700	1700	
Volume to Capacity	0.04	0.01	0.19	0.33	0.17	
Queue Length 95th (ft)	3	1	0	0	0	
Control Delay (s)	18.2	0.4	0.0	0.0	0.0	
Lane LOS	C	A				
Approach Delay (s)	18.2	0.2		0.0		
Approach LOS	C					
Intersection Summary						
Average Delay	0.2					
Intersection Capacity Utilization	31.4%			ICU Level of Service	A	
Analysis Period (min)	15					

HCM Unsignalized Intersection Capacity Analysis

14: CO 83 & Benet Lane

09/01/2021



Movement	EBL	EBR	NBL	NBT	SBT	SBR
Lane Configurations						
Traffic Volume (veh/h)	5	15	10	415	750	5
Future Volume (Veh/h)	5	15	10	415	750	5
Sign Control	Stop			Free	Free	
Grade	0%			0%	0%	
Peak Hour Factor	0.38	0.38	0.86	0.86	0.89	0.89
Hourly flow rate (vph)	13	39	12	483	843	6
Pedestrians						
Lane Width (ft)						
Walking Speed (ft/s)						
Percent Blockage						
Right turn flare (veh)						
Median type				None	None	
Median storage (veh)						
Upstream signal (ft)						
pX, platoon unblocked						
vC, conflicting volume	1112	424	849			
vC1, stage 1 conf vol						
vC2, stage 2 conf vol						
vCu, unblocked vol	1112	424	849			
tC, single (s)	7.1	7.2	4.4			
tC, 2 stage (s)						
tF (s)	3.6	3.4	2.3			
p0 queue free %	93	93	98			
cM capacity (veh/h)	183	549	718			
Direction, Lane #	EB 1	NB 1	NB 2	NB 3	SB 1	SB 2
Volume Total	52	12	242	242	562	287
Volume Left	13	12	0	0	0	0
Volume Right	39	0	0	0	0	6
cSH	366	718	1700	1700	1700	1700
Volume to Capacity	0.14	0.02	0.14	0.14	0.33	0.17
Queue Length 95th (ft)	12	1	0	0	0	0
Control Delay (s)	16.5	10.1	0.0	0.0	0.0	0.0
Lane LOS	C	B				
Approach Delay (s)	16.5	0.2			0.0	
Approach LOS	C					
Intersection Summary						
Average Delay			0.7			
Intersection Capacity Utilization			30.9%	ICU Level of Service	A	
Analysis Period (min)			15			

HCM Unsignalized Intersection Capacity Analysis
 15: CO 83 & High Forest Rd

09/01/2021



Movement	WBL	WBR	NBT	NBR	SBL	SBT	
Lane Configurations							
Traffic Volume (veh/h)	65	15	370	35	10	690	
Future Volume (Veh/h)	65	15	370	35	10	690	
Sign Control	Stop		Free		Free		
Grade	0%		0%		0%		
Peak Hour Factor	0.88	0.88	0.85	0.85	0.89	0.89	
Hourly flow rate (vph)	74	17	435	41	11	775	
Pedestrians							
Lane Width (ft)							
Walking Speed (ft/s)							
Percent Blockage							
Right turn flare (veh)							
Median type			None		None		
Median storage (veh)							
Upstream signal (ft)							
pX, platoon unblocked							
vC, conflicting volume	844	218			476		
vC1, stage 1 conf vol							
vC2, stage 2 conf vol							
vCu, unblocked vol	844	218			476		
tC, single (s)	7.1	7.2			4.4		
tC, 2 stage (s)							
tF (s)	3.6	3.4			2.3		
p0 queue free %	73	98			99		
cM capacity (veh/h)	278	754			1009		
Direction, Lane #	WB 1	NB 1	NB 2	NB 3	SB 1	SB 2	SB 3
Volume Total	91	218	218	41	11	388	388
Volume Left	74	0	0	0	11	0	0
Volume Right	17	0	0	41	0	0	0
cSH	315	1700	1700	1700	1009	1700	1700
Volume to Capacity	0.29	0.13	0.13	0.02	0.01	0.23	0.23
Queue Length 95th (ft)	29	0	0	0	1	0	0
Control Delay (s)	21.0	0.0	0.0	0.0	8.6	0.0	0.0
Lane LOS	C			A			
Approach Delay (s)	21.0	0.0			0.1		
Approach LOS	C						
Intersection Summary							
Average Delay			1.5				
Intersection Capacity Utilization			30.3%		ICU Level of Service		A
Analysis Period (min)			15				

HCM Unsignalized Intersection Capacity Analysis
 16: CO 83 & Arena Rd

09/01/2021



Movement	EBL	EBR	NBL	NBT	SBT	SBR
Lane Configurations						
Traffic Volume (veh/h)	5	5	1	390	690	5
Future Volume (Veh/h)	5	5	1	390	690	5
Sign Control	Stop			Free	Free	
Grade	0%			0%	0%	
Peak Hour Factor	0.50	0.50	0.87	0.87	0.89	0.89
Hourly flow rate (vph)	10	10	1	448	775	6
Pedestrians						
Lane Width (ft)						
Walking Speed (ft/s)						
Percent Blockage						
Right turn flare (veh)						
Median type				None	None	
Median storage (veh)						
Upstream signal (ft)						
pX, platoon unblocked						
vC, conflicting volume	1004	390	781			
vC1, stage 1 conf vol						
vC2, stage 2 conf vol						
vCu, unblocked vol	1004	390	781			
tC, single (s)	7.1	7.2	4.4			
tC, 2 stage (s)						
tF (s)	3.6	3.4	2.3			
p0 queue free %	95	98	100			
cM capacity (veh/h)	220	578	764			
Direction, Lane #	EB 1	NB 1	NB 2	SB 1	SB 2	
Volume Total	20	150	299	517	264	
Volume Left	10	1	0	0	0	
Volume Right	10	0	0	0	6	
cSH	319	764	1700	1700	1700	
Volume to Capacity	0.06	0.00	0.18	0.30	0.16	
Queue Length 95th (ft)	5	0	0	0	0	
Control Delay (s)	17.1	0.1	0.0	0.0	0.0	
Lane LOS	C	A				
Approach Delay (s)	17.1	0.0		0.0		
Approach LOS	C					
Intersection Summary						
Average Delay			0.3			
Intersection Capacity Utilization			29.2%	ICU Level of Service	A	
Analysis Period (min)			15			

HCM Signalized Intersection Capacity Analysis

17: CO 83 & Hogden Rd

09/01/2021

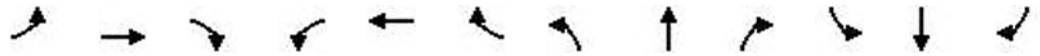

Movement	EBL	EBT	EBR	WBL	WBT	WBR	NBL	NBT	NBR	SBL	SBT	SBR
Lane Configurations												
Traffic Volume (vph)	45	105	65	315	185	325	70	225	90	110	360	40
Future Volume (vph)	45	105	65	315	185	325	70	225	90	110	360	40
Ideal Flow (vphpl)	1900	1900	1900	1900	1900	1900	1900	1900	1900	1900	1900	1900
Total Lost time (s)	6.0	6.0	6.0	6.0	6.0	6.0	6.0	7.0	7.0	6.0	7.0	
Lane Util. Factor	1.00	1.00	1.00	1.00	1.00	1.00	1.00	1.00	1.00	1.00	1.00	
Frt	1.00	1.00	0.85	1.00	1.00	0.85	1.00	1.00	0.85	1.00	0.98	
Flt Protected	0.95	1.00	1.00	0.95	1.00	1.00	0.95	1.00	1.00	0.95	1.00	
Satd. Flow (prot)	1597	1681	1429	1597	1681	1429	1597	1681	1429	1597	1656	
Flt Permitted	0.95	1.00	1.00	0.95	1.00	1.00	0.33	1.00	1.00	0.50	1.00	
Satd. Flow (perm)	1597	1681	1429	1597	1681	1429	557	1681	1429	849	1656	
Peak-hour factor, PHF	0.71	0.71	0.71	0.92	0.92	0.92	0.89	0.89	0.89	0.94	0.94	0.94
Adj. Flow (vph)	63	148	92	342	201	353	79	253	101	117	383	43
RTOR Reduction (vph)	0	0	81	0	0	263	0	0	66	0	3	0
Lane Group Flow (vph)	63	148	11	342	201	90	79	253	35	117	423	0
Turn Type	Split	NA	Perm	Split	NA	Perm	pm+pt	NA	Perm	pm+pt	NA	
Protected Phases	4	4		8	8		5	2		1	6	
Permitted Phases			4			8	2		2	6		
Actuated Green, G (s)	14.2	14.2	14.2	29.2	29.2	29.2	44.4	39.8	39.8	47.4	41.3	
Effective Green, g (s)	14.2	14.2	14.2	29.2	29.2	29.2	44.4	39.8	39.8	47.4	41.3	
Actuated g/C Ratio	0.12	0.12	0.12	0.26	0.26	0.26	0.39	0.35	0.35	0.41	0.36	
Clearance Time (s)	6.0	6.0	6.0	6.0	6.0	6.0	6.0	7.0	7.0	6.0	7.0	
Vehicle Extension (s)	3.0	3.0	3.0	3.0	3.0	3.0	3.0	3.0	3.0	3.0	3.0	
Lane Grp Cap (vph)	198	208	177	407	429	365	258	585	497	391	598	
v/s Ratio Prot	0.04	c0.09		c0.21	0.12		0.01	0.15		c0.02	c0.26	
v/s Ratio Perm			0.01			0.06	0.11		0.02	0.11		
v/c Ratio	0.32	0.71	0.06	0.84	0.47	0.25	0.31	0.43	0.07	0.30	0.71	
Uniform Delay, d1	45.6	48.1	44.2	40.3	36.0	33.8	23.4	28.6	24.9	21.3	31.3	
Progression Factor	1.00	1.00	1.00	1.00	1.00	1.00	1.00	1.00	1.00	1.00	1.00	
Incremental Delay, d2	0.9	10.9	0.2	14.4	0.8	0.4	0.7	0.5	0.1	0.4	3.8	
Delay (s)	46.6	59.0	44.3	54.8	36.8	34.2	24.1	29.1	25.0	21.8	35.1	
Level of Service	D	E	D	D	D	C	C	C	C	C	D	
Approach Delay (s)		52.0			42.6			27.2			32.2	
Approach LOS		D			D			C			C	

Intersection Summary

HCM 2000 Control Delay	38.3	HCM 2000 Level of Service	D
HCM 2000 Volume to Capacity ratio	0.73		
Actuated Cycle Length (s)	114.3	Sum of lost time (s)	25.0
Intersection Capacity Utilization	80.2%	ICU Level of Service	D
Analysis Period (min)	15		

c Critical Lane Group

HCM Unsignalized Intersection Capacity Analysis

18: CO 83 & Walden Way

09/01/2021



Movement	WBL	WBR	NBT	NBR	SBL	SBT
Lane Configurations						
Traffic Volume (veh/h)	10	70	673	5	20	535
Future Volume (Veh/h)	10	70	673	5	20	535
Sign Control	Stop		Free		Free	
Grade	0%		0%		0%	
Peak Hour Factor	0.35	0.35	0.93	0.93	0.90	0.90
Hourly flow rate (vph)	29	200	724	5	22	594
Pedestrians						
Lane Width (ft)						
Walking Speed (ft/s)						
Percent Blockage						
Right turn flare (veh)						
Median type	None			None		
Median storage (veh)						
Upstream signal (ft)						
pX, platoon unblocked						
vC, conflicting volume	1364	726			729	
vC1, stage 1 conf vol						
vC2, stage 2 conf vol						
vCu, unblocked vol	1364	726			729	
tC, single (s)	6.5	6.3			4.2	
tC, 2 stage (s)						
tF (s)	3.6	3.4			2.3	
p0 queue free %	81	51			97	
cM capacity (veh/h)	150	406			827	
Direction, Lane #	WB 1	NB 1	SB 1			
Volume Total	229	729	616			
Volume Left	29	0	22			
Volume Right	200	5	0			
cSH	334	1700	827			
Volume to Capacity	0.69	0.43	0.03			
Queue Length 95th (ft)	120	0	2			
Control Delay (s)	36.3	0.0	0.7			
Lane LOS	E		A			
Approach Delay (s)	36.3	0.0	0.7			
Approach LOS	E					
Intersection Summary						
Average Delay			5.6			
Intersection Capacity Utilization			55.9%		ICU Level of Service	B
Analysis Period (min)			15			

HCM Signalized Intersection Capacity Analysis
 19: CO 83 & CR 105/Walker Rd

09/01/2021

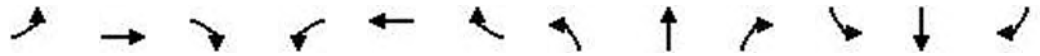

Movement	EBL	EBT	EBR	WBL	WBT	WBR	NBL	NBT	NBR	SBL	SBT	SBR
Lane Configurations												
Traffic Volume (vph)	70	550	180	290	475	135	300	345	125	170	295	100
Future Volume (vph)	70	550	180	290	475	135	300	345	125	170	295	100
Ideal Flow (vphpl)	1900	1900	1900	1900	1900	1900	1900	1900	1900	1900	1900	1900
Total Lost time (s)	4.5	6.0	4.0	4.5	6.0	6.0	5.0	7.0	7.0	5.0	7.0	7.0
Lane Util. Factor	1.00	0.95	1.00	1.00	0.95	1.00	1.00	1.00	1.00	1.00	1.00	1.00
Frt	1.00	1.00	0.85	1.00	1.00	0.85	1.00	1.00	0.85	1.00	1.00	0.85
Flt Protected	0.95	1.00	1.00	0.95	1.00	1.00	0.95	1.00	1.00	0.95	1.00	1.00
Satd. Flow (prot)	1597	3195	1429	1597	3195	1429	1597	1681	1429	1597	1681	1429
Flt Permitted	0.37	1.00	1.00	0.12	1.00	1.00	0.28	1.00	1.00	0.32	1.00	1.00
Satd. Flow (perm)	629	3195	1429	201	3195	1429	471	1681	1429	531	1681	1429
Peak-hour factor, PHF	0.64	0.64	0.64	0.65	0.65	0.65	0.98	0.98	0.98	0.83	0.83	0.83
Adj. Flow (vph)	109	859	281	446	731	208	306	352	128	205	355	120
RTOR Reduction (vph)	0	0	0	0	0	128	0	0	94	0	0	89
Lane Group Flow (vph)	109	859	281	446	731	80	306	352	34	205	355	31
Turn Type	pm+pt	NA	Free	pm+pt	NA	Perm	pm+pt	NA	Perm	pm+pt	NA	Perm
Protected Phases	7	4		3	8		5	2		1	6	
Permitted Phases	4		Free	8		8	2		2	6		6
Actuated Green, G (s)	37.8	29.0	118.9	59.0	45.7	45.7	42.9	31.9	31.9	40.9	30.9	30.9
Effective Green, g (s)	37.8	29.0	118.9	59.0	45.7	45.7	42.9	31.9	31.9	40.9	30.9	30.9
Actuated g/C Ratio	0.32	0.24	1.00	0.50	0.38	0.38	0.36	0.27	0.27	0.34	0.26	0.26
Clearance Time (s)	4.5	6.0		4.5	6.0	6.0	5.0	7.0	7.0	5.0	7.0	7.0
Vehicle Extension (s)	3.0	3.0		3.0	3.0	3.0	3.0	3.0	3.0	3.0	3.0	3.0
Lane Grp Cap (vph)	271	779	1429	399	1228	549	274	451	383	272	436	371
v/s Ratio Prot	0.03	0.27		c0.24	0.23		c0.10	0.21		0.06	0.21	
v/s Ratio Perm	0.10		c0.20	c0.32		0.06	c0.30		0.02	0.20		0.02
v/c Ratio	0.40	1.10	0.20	1.12	0.60	0.15	1.12	0.78	0.09	0.75	0.81	0.08
Uniform Delay, d1	29.7	45.0	0.0	36.1	29.2	23.9	35.5	40.3	32.6	31.8	41.3	33.3
Progression Factor	1.00	1.00	1.00	1.00	1.00	1.00	1.00	1.00	1.00	1.00	1.00	1.00
Incremental Delay, d2	1.0	64.1	0.3	81.0	0.8	0.1	89.5	8.5	0.1	11.2	11.1	0.1
Delay (s)	30.7	109.1	0.3	117.1	30.0	24.0	125.0	48.8	32.7	43.0	52.4	33.4
Level of Service	C	F	A	F	C	C	F	D	C	D	D	C
Approach Delay (s)		77.7			57.1			75.8			46.2	
Approach LOS		E			E			E			D	

Intersection Summary		
HCM 2000 Control Delay	65.2	HCM 2000 Level of Service
HCM 2000 Volume to Capacity ratio	1.16	E
Actuated Cycle Length (s)	118.9	Sum of lost time (s)
Intersection Capacity Utilization	91.6%	22.5
Analysis Period (min)	15	ICU Level of Service
		F

c Critical Lane Group

HCM Signalized Intersection Capacity Analysis
 20: CO 83 & E Palmer Divide Ave

09/01/2021

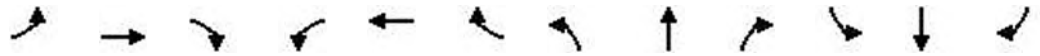

Movement	EBL	EBT	EBR	WBL	WBT	WBR	NBL	NBT	NBR	SBL	SBT	SBR
Lane Configurations												
Traffic Volume (vph)	20	25	105	160	70	20	150	305	30	5	170	25
Future Volume (vph)	20	25	105	160	70	20	150	305	30	5	170	25
Ideal Flow (vphpl)	1900	1900	1900	1900	1900	1900	1900	1900	1900	1900	1900	1900
Total Lost time (s)	4.5	7.0	7.0	4.5	7.0	7.0	4.5	8.0		4.5	8.0	
Lane Util. Factor	1.00	1.00	1.00	1.00	1.00	1.00	1.00	1.00		1.00	1.00	
Frt	1.00	1.00	0.85	1.00	1.00	0.85	1.00	0.99		1.00	0.98	
Flt Protected	0.95	1.00	1.00	0.95	1.00	1.00	0.95	1.00		0.95	1.00	
Satd. Flow (prot)	1597	1681	1429	1597	1681	1429	1597	1659		1597	1649	
Flt Permitted	0.71	1.00	1.00	0.54	1.00	1.00	0.49	1.00		0.55	1.00	
Satd. Flow (perm)	1186	1681	1429	903	1681	1429	831	1659		918	1649	
Peak-hour factor, PHF	0.69	0.69	0.69	0.89	0.89	0.89	0.93	0.93	0.93	0.84	0.84	0.84
Adj. Flow (vph)	29	36	152	180	79	22	161	328	32	6	202	30
RTOR Reduction (vph)	0	0	129	0	0	16	0	3	0	0	5	0
Lane Group Flow (vph)	29	36	23	180	79	6	161	357	0	6	227	0
Turn Type	pm+pt	NA	Perm	pm+pt	NA	Perm	pm+pt	NA		pm+pt	NA	
Protected Phases	7	4		3	8		5	2		1	6	
Permitted Phases	4		4	8		8	2			6		
Actuated Green, G (s)	14.5	12.3	12.3	28.4	21.7	21.7	38.1	32.6		23.4	22.4	
Effective Green, g (s)	14.5	12.3	12.3	28.4	21.7	21.7	38.1	32.6		23.4	22.4	
Actuated g/C Ratio	0.18	0.15	0.15	0.35	0.27	0.27	0.47	0.40		0.29	0.27	
Clearance Time (s)	4.5	7.0	7.0	4.5	7.0	7.0	4.5	8.0		4.5	8.0	
Vehicle Extension (s)	3.0	5.0	5.0	3.0	5.0	5.0	3.0	5.0		3.0	5.0	
Lane Grp Cap (vph)	222	253	215	413	447	380	493	663		271	453	
v/s Ratio Prot	0.00	0.02		c0.06	0.05		c0.04	c0.22		0.00	0.14	
v/s Ratio Perm	0.02		0.02	c0.09		0.00	0.11			0.01		
v/c Ratio	0.13	0.14	0.11	0.44	0.18	0.02	0.33	0.54		0.02	0.50	
Uniform Delay, d1	28.0	30.0	29.9	19.6	23.0	22.0	13.1	18.7		20.8	24.8	
Progression Factor	1.00	1.00	1.00	1.00	1.00	1.00	1.00	1.00		1.00	1.00	
Incremental Delay, d2	0.3	0.5	0.5	0.7	0.4	0.0	0.4	1.5		0.0	1.8	
Delay (s)	28.3	30.6	30.3	20.4	23.4	22.1	13.4	20.2		20.8	26.7	
Level of Service	C	C	C	C	C	C	B	C		C	C	
Approach Delay (s)		30.1			21.4			18.1			26.5	
Approach LOS		C			C			B			C	

Intersection Summary

HCM 2000 Control Delay	22.5	HCM 2000 Level of Service	C
HCM 2000 Volume to Capacity ratio	0.53		
Actuated Cycle Length (s)	81.5	Sum of lost time (s)	24.0
Intersection Capacity Utilization	53.8%	ICU Level of Service	A
Analysis Period (min)	15		

c Critical Lane Group

HCM Unsignalized Intersection Capacity Analysis
 43: CO 83 & Pinehurst RI only

09/01/2021



Movement	WBL	WBR	NBT	NBR	SBL	SBT
Lane Configurations			↑	↗		↑↑
Traffic Volume (veh/h)	0	0	600	235	0	765
Future Volume (Veh/h)	0	0	600	235	0	765
Sign Control	Stop		Free		Free	
Grade	0%		0%		0%	
Peak Hour Factor	0.92	0.92	0.92	0.92	0.92	0.92
Hourly flow rate (vph)	0	0	652	255	0	832
Pedestrians						
Lane Width (ft)						
Walking Speed (ft/s)						
Percent Blockage						
Right turn flare (veh)						
Median type	None			None		
Median storage (veh)						
Upstream signal (ft)						
pX, platoon unblocked						
vC, conflicting volume	1068	652			907	
vC1, stage 1 conf vol						
vC2, stage 2 conf vol						
vCu, unblocked vol	1068	652			907	
tC, single (s)	7.1	7.2			4.4	
tC, 2 stage (s)						
tF (s)	3.6	3.4			2.3	
p0 queue free %	100	100			100	
cM capacity (veh/h)	199	385			681	
Direction, Lane #	NB 1	NB 2	SB 1	SB 2		
Volume Total	652	255	416	416		
Volume Left	0	0	0	0		
Volume Right	0	255	0	0		
cSH	1700	1700	1700	1700		
Volume to Capacity	0.38	0.15	0.24	0.24		
Queue Length 95th (ft)	0	0	0	0		
Control Delay (s)	0.0	0.0	0.0	0.0		
Lane LOS						
Approach Delay (s)	0.0		0.0			
Approach LOS						
Intersection Summary						
Average Delay			0.0			
Intersection Capacity Utilization			34.9%	ICU Level of Service	A	
Analysis Period (min)			15			

HCM Signalized Intersection Capacity Analysis

1: CO 83 & SO 21 SB

09/01/2021



Movement	SEL	SET	SER	NWL	NWT	NWR	NEL	NET	NER	SWL	SWT	SWR
Lane Configurations	↑↑		↑					↑↑↑	↑	↑↑	↑↑↑	
Traffic Volume (vph)	600	0	450	0	0	0	0	810	715	675	635	0
Future Volume (vph)	600	0	450	0	0	0	0	810	715	675	635	0
Ideal Flow (vphpl)	1900	1900	1900	1900	1900	1900	1900	1900	1900	1900	1900	1900
Total Lost time (s)	4.5		4.5					7.5	4.0	5.0	7.5	
Lane Util. Factor	0.97		1.00					0.91	1.00	0.97	0.91	
Frt	1.00		0.85					1.00	0.85	1.00	1.00	
Flt Protected	0.95		1.00					1.00	1.00	0.95	1.00	
Satd. Flow (prot)	3099		1429					4590	1429	3099	4590	
Flt Permitted	0.95		1.00					1.00	1.00	0.22	1.00	
Satd. Flow (perm)	3099		1429					4590	1429	713	4590	
Peak-hour factor, PHF	0.92	0.92	0.92	0.92	0.92	0.92	0.92	0.91	0.91	0.90	0.90	0.92
Adj. Flow (vph)	652	0	489	0	0	0	0	890	786	750	706	0
RTOR Reduction (vph)	0	0	138	0	0	0	0	0	0	0	0	0
Lane Group Flow (vph)	652	0	351	0	0	0	0	890	786	750	706	0
Turn Type	Prot		Perm					NA	Free	pm+pt	NA	
Protected Phases	4							2		1	6	
Permitted Phases	4		4						Free	6		
Actuated Green, G (s)	35.1		35.1					44.3	120.0	72.9	72.9	
Effective Green, g (s)	35.1		35.1					44.3	120.0	72.9	72.9	
Actuated g/C Ratio	0.29		0.29					0.37	1.00	0.61	0.61	
Clearance Time (s)	4.5		4.5					7.5		5.0	7.5	
Vehicle Extension (s)	3.0		3.0					1.0		3.0	1.0	
Lane Grp Cap (vph)	906		417					1694	1429	902	2788	
v/s Ratio Prot	0.21							0.19		c0.16	0.15	
v/s Ratio Perm			c0.25						0.55	c0.34		
v/c Ratio	0.72		0.84					0.53	0.55	0.83	0.25	
Uniform Delay, d1	38.0		39.8					29.6	0.0	16.7	10.9	
Progression Factor	1.00		1.00					1.00	1.00	1.49	1.38	
Incremental Delay, d2	2.8		14.2					1.2	1.5	5.6	0.2	
Delay (s)	40.8		54.1					30.8	1.5	30.5	15.3	
Level of Service	D		D					C	A	C	B	
Approach Delay (s)		46.5			0.0			17.1			23.1	
Approach LOS		D			A			B			C	

Intersection Summary

HCM 2000 Control Delay	27.0	HCM 2000 Level of Service	C
HCM 2000 Volume to Capacity ratio	0.86		
Actuated Cycle Length (s)	120.0	Sum of lost time (s)	17.0
Intersection Capacity Utilization	70.3%	ICU Level of Service	C
Analysis Period (min)	15		

c Critical Lane Group

HCM Signalized Intersection Capacity Analysis

2: CO 83 & CO 21 NB

09/01/2021



Movement	SEL	SET	SER	NWL	NWT	NWR	NEL	NET	NER	SWL	SWT	SWR
Lane Configurations				↔↔		↗	↔↔	↕↕↕			↕↕↕	↗
Traffic Volume (vph)	0	0	0	595	0	610	600	810	0	0	715	350
Future Volume (vph)	0	0	0	595	0	610	600	810	0	0	715	350
Ideal Flow (vphpl)	1900	1900	1900	1900	1900	1900	1900	1900	1900	1900	1900	1900
Total Lost time (s)				6.5		4.0	4.5	7.5			6.5	6.5
Lane Util. Factor				0.97		1.00	0.97	0.91			0.91	1.00
Frt				1.00		0.85	1.00	1.00			1.00	0.85
Flt Protected				0.95		1.00	0.95	1.00			1.00	1.00
Satd. Flow (prot)				3099		1429	3099	4590			4590	1429
Flt Permitted				0.95		1.00	0.95	1.00			1.00	1.00
Satd. Flow (perm)				3099		1429	3099	4590			4590	1429
Peak-hour factor, PHF	0.92	0.92	0.92	0.96	0.92	0.96	0.92	0.90	0.90	0.89	0.89	0.92
Adj. Flow (vph)	0	0	0	620	0	635	652	900	0	0	803	380
RTOR Reduction (vph)	0	0	0	0	0	0	0	0	0	0	0	240
Lane Group Flow (vph)	0	0	0	620	0	635	652	900	0	0	803	140
Turn Type				Prot		Free	Prot	NA			NA	Perm
Protected Phases				4			5	2			6	
Permitted Phases						Free						6
Actuated Green, G (s)				28.3		120.0	30.1	77.7			44.1	44.1
Effective Green, g (s)				28.3		120.0	30.1	77.7			44.1	44.1
Actuated g/C Ratio				0.24		1.00	0.25	0.65			0.37	0.37
Clearance Time (s)				6.5			4.5	7.5			6.5	6.5
Vehicle Extension (s)				2.0			3.0	1.0			1.0	1.0
Lane Grp Cap (vph)				730		1429	777	2972			1686	525
v/s Ratio Prot				c0.20			c0.21	0.20			0.17	
v/s Ratio Perm						c0.44						0.10
v/c Ratio				0.85		0.44	0.84	0.30			0.48	0.27
Uniform Delay, d1				43.8		0.0	42.7	9.3			29.1	26.6
Progression Factor				1.00		1.00	0.85	0.33			1.00	1.00
Incremental Delay, d2				8.8		1.0	6.8	0.2			1.0	1.2
Delay (s)				52.6		1.0	43.1	3.3			30.1	27.8
Level of Service				D		A	D	A			C	C
Approach Delay (s)		0.0			26.5			20.0			29.3	
Approach LOS		A			C			C			C	

Intersection Summary

HCM 2000 Control Delay	24.8	HCM 2000 Level of Service	C
HCM 2000 Volume to Capacity ratio	0.70		
Actuated Cycle Length (s)	120.0	Sum of lost time (s)	17.5
Intersection Capacity Utilization	70.3%	ICU Level of Service	C
Analysis Period (min)	15		

c Critical Lane Group

Intersection has too many lanes per leg.

HCM All-Way analysis is limited to two lanes per leg.

Channelized right turn lanes are not counted.

HCM Signalized Intersection Capacity Analysis

4: CO 83 & Shoup Road

09/01/2021

	↑	↗	↘	↓	↙	↖
Movement	NBT	NBR	SBL	SBT	SWL	SWR
Lane Configurations	↑↑↑	↗	↘	↑↑↑	↙	↖
Traffic Volume (vph)	1100	435	290	930	435	290
Future Volume (vph)	1100	435	290	930	435	290
Ideal Flow (vphpl)	1900	1900	1900	1900	1900	1900
Total Lost time (s)	7.5	4.0	5.0	7.5	6.0	4.0
Lane Util. Factor	0.91	1.00	1.00	0.91	1.00	1.00
Frt	1.00	0.85	1.00	1.00	1.00	0.85
Flt Protected	1.00	1.00	0.95	1.00	0.95	1.00
Satd. Flow (prot)	4590	1429	1597	4590	1597	1429
Flt Permitted	1.00	1.00	0.12	1.00	0.95	1.00
Satd. Flow (perm)	4590	1429	195	4590	1597	1429
Peak-hour factor, PHF	0.97	0.97	0.93	0.93	0.79	0.79
Adj. Flow (vph)	1134	448	312	1000	551	367
RTOR Reduction (vph)	0	0	0	0	0	0
Lane Group Flow (vph)	1134	448	312	1000	551	367
Turn Type	NA	Free	pm+pt	NA	Prot	Free
Protected Phases	2		1	6	8	
Permitted Phases		Free	6			Free
Actuated Green, G (s)	35.1	112.0	58.1	58.1	40.4	112.0
Effective Green, g (s)	35.1	112.0	58.1	58.1	40.4	112.0
Actuated g/C Ratio	0.31	1.00	0.52	0.52	0.36	1.00
Clearance Time (s)	7.5		5.0	7.5	6.0	
Vehicle Extension (s)	1.0		1.0	1.0	3.0	
Lane Grp Cap (vph)	1438	1429	326	2381	576	1429
v/s Ratio Prot	0.25		c0.15	0.22	c0.34	
v/s Ratio Perm		0.31	c0.34			0.26
v/c Ratio	0.79	0.31	0.96	0.42	0.96	0.26
Uniform Delay, d1	35.1	0.0	30.3	16.6	34.9	0.0
Progression Factor	1.00	1.00	1.00	1.00	1.00	1.00
Incremental Delay, d2	4.5	0.6	37.8	0.5	26.7	0.4
Delay (s)	39.5	0.6	68.2	17.1	61.7	0.4
Level of Service	D	A	E	B	E	A
Approach Delay (s)	28.5			29.3	37.2	
Approach LOS	C			C	D	

Intersection Summary			
HCM 2000 Control Delay	30.9	HCM 2000 Level of Service	C
HCM 2000 Volume to Capacity ratio	0.98		
Actuated Cycle Length (s)	112.0	Sum of lost time (s)	18.5
Intersection Capacity Utilization	76.8%	ICU Level of Service	D
Analysis Period (min)	15		

c Critical Lane Group

HCM Signalized Intersection Capacity Analysis
5: CO 83 & Flying Horse Club Dr/Abert Way

09/01/2021

Movement	EBL	EBT	EBR	WBL	WBT	WBR	NBL	NBT	NBR	SBL	SBT	SBR
Lane Configurations												
Traffic Volume (vph)	155	5	290	5	0	5	255	1125	10	10	990	140
Future Volume (vph)	155	5	290	5	0	5	255	1125	10	10	990	140
Ideal Flow (vphpl)	1900	1900	1900	1900	1900	1900	1900	1900	1900	1900	1900	1900
Total Lost time (s)	7.0	7.0	7.0	7.0	7.0		7.0	8.0	8.0	7.0	8.0	8.0
Lane Util. Factor	1.00	1.00	1.00	1.00	1.00		1.00	0.91	1.00	1.00	0.91	1.00
Frpb, ped/bikes	1.00	1.00	1.00	1.00	1.00		1.00	1.00	0.97	1.00	1.00	1.00
Flpb, ped/bikes	1.00	1.00	1.00	1.00	1.00		1.00	1.00	1.00	1.00	1.00	1.00
Frt	1.00	1.00	0.85	1.00	0.85		1.00	1.00	0.85	1.00	1.00	0.85
Flt Protected	0.95	1.00	1.00	0.95	1.00		0.95	1.00	1.00	0.95	1.00	1.00
Satd. Flow (prot)	1597	1681	1429	1597	1429		1597	4590	1393	1597	4590	1429
Flt Permitted	0.75	1.00	1.00	0.75	1.00		0.18	1.00	1.00	0.24	1.00	1.00
Satd. Flow (perm)	1266	1681	1429	1267	1429		300	4590	1393	395	4590	1429
Peak-hour factor, PHF	0.80	0.80	0.80	0.69	0.69	0.69	0.98	0.98	0.98	0.92	0.92	0.92
Adj. Flow (vph)	194	6	362	7	0	7	260	1148	10	11	1076	152
RTOR Reduction (vph)	0	0	213	0	6	0	0	0	4	0	0	87
Lane Group Flow (vph)	194	6	150	7	1	0	260	1148	6	11	1076	65
Confl. Peds. (#/hr)									6	6		
Turn Type	Perm	NA	Perm	Perm	NA		pm+pt	NA	Perm	pm+pt	NA	Perm
Protected Phases		4			8		5	2		1	6	
Permitted Phases	4		4	8			2		2	6		6
Actuated Green, G (s)	19.2	19.2	19.2	19.2	19.2		62.2	54.0	54.0	42.7	41.5	41.5
Effective Green, g (s)	19.2	19.2	19.2	19.2	19.2		62.2	54.0	54.0	42.7	41.5	41.5
Actuated g/C Ratio	0.20	0.20	0.20	0.20	0.20		0.65	0.56	0.56	0.44	0.43	0.43
Clearance Time (s)	7.0	7.0	7.0	7.0	7.0		7.0	8.0	8.0	7.0	8.0	8.0
Vehicle Extension (s)	3.0	3.0	3.0	3.0	3.0		3.0	3.0	3.0	3.0	3.0	3.0
Lane Grp Cap (vph)	252	334	284	252	284		377	2571	780	189	1975	615
v/s Ratio Prot		0.00			0.00		c0.10	0.25		0.00	0.23	
v/s Ratio Perm	c0.15		0.10	0.01			c0.35		0.00	0.02		0.05
v/c Ratio	0.77	0.02	0.53	0.03	0.00		0.69	0.45	0.01	0.06	0.54	0.11
Uniform Delay, d1	36.5	31.0	34.5	31.1	30.9		10.0	12.4	9.4	15.1	20.4	16.4
Progression Factor	1.00	1.00	1.00	1.00	1.00		1.00	1.00	1.00	1.00	1.00	1.00
Incremental Delay, d2	13.2	0.0	1.8	0.0	0.0		5.2	0.1	0.0	0.1	0.3	0.1
Delay (s)	49.7	31.0	36.3	31.1	30.9		15.2	12.6	9.4	15.2	20.7	16.5
Level of Service	D	C	D	C	C		B	B	A	B	C	B
Approach Delay (s)		40.9			31.0			13.0			20.2	
Approach LOS		D			C			B			C	
Intersection Summary												
HCM 2000 Control Delay			20.7				HCM 2000 Level of Service		C			
HCM 2000 Volume to Capacity ratio			0.74									
Actuated Cycle Length (s)			96.4				Sum of lost time (s)		22.0			
Intersection Capacity Utilization			76.9%				ICU Level of Service		D			
Analysis Period (min)			15									
c Critical Lane Group												

HCM Signalized Intersection Capacity Analysis

6: CO 83 & North Gate Blvd

09/01/2021



Movement	EBL	EBT	EBR	WBL	WBT	WBR	NBL	NBT	NBR	SBL	SBT	SBR
Lane Configurations												
Traffic Volume (vph)	110	10	480	5	5	5	455	830	15	10	665	95
Future Volume (vph)	110	10	480	5	5	5	455	830	15	10	665	95
Ideal Flow (vphpl)	1900	1900	1900	1900	1900	1900	1900	1900	1900	1900	1900	1900
Total Lost time (s)	6.0	6.0	6.0		6.0		5.0	7.0		7.0	7.0	7.0
Lane Util. Factor	1.00	1.00	1.00		1.00		0.97	0.95		1.00	0.95	1.00
Frbp, ped/bikes	1.00	1.00	1.00		1.00		1.00	1.00		1.00	1.00	1.00
Flpb, ped/bikes	1.00	1.00	1.00		1.00		1.00	1.00		1.00	1.00	1.00
Frt	1.00	1.00	0.85		0.95		1.00	1.00		1.00	1.00	0.85
Flt Protected	0.95	1.00	1.00		0.98		0.95	1.00		0.95	1.00	1.00
Satd. Flow (prot)	1438	1513	1286		1421		2789	2866		1433	2875	1286
Flt Permitted	0.74	1.00	1.00		0.93		0.95	1.00		0.32	1.00	1.00
Satd. Flow (perm)	1116	1513	1286		1338		2789	2866		478	2875	1286
Peak-hour factor, PHF	0.92	0.92	0.92	0.50	0.50	0.50	0.94	0.94	0.94	0.96	0.96	0.96
Adj. Flow (vph)	120	11	522	10	10	10	484	883	16	10	693	99
RTOR Reduction (vph)	0	0	409	0	8	0	0	1	0	0	0	52
Lane Group Flow (vph)	120	11	113	0	22	0	484	898	0	10	693	47
Confl. Peds. (#/hr)									7	7		
Turn Type	Perm	NA	Perm	Perm	NA		Prot	NA		Perm	NA	Perm
Protected Phases		4			8		5	2			6	
Permitted Phases	4		4	8						6		6
Actuated Green, G (s)	20.4	20.4	20.4		20.4		24.9	86.5		56.6	56.6	56.6
Effective Green, g (s)	20.4	20.4	20.4		20.4		24.9	86.5		56.6	56.6	56.6
Actuated g/C Ratio	0.17	0.17	0.17		0.17		0.21	0.72		0.47	0.47	0.47
Clearance Time (s)	6.0	6.0	6.0		6.0		5.0	7.0		7.0	7.0	7.0
Vehicle Extension (s)	3.0	3.0	3.0		3.0		3.0	3.0		3.0	3.0	3.0
Lane Grp Cap (vph)	189	257	218		227		579	2067		225	1357	607
v/s Ratio Prot		0.01					c0.17	0.31			c0.24	
v/s Ratio Perm	c0.11		0.09		0.02					0.02		0.04
v/c Ratio	0.63	0.04	0.52		0.10		0.84	0.43		0.04	0.51	0.08
Uniform Delay, d1	46.3	41.6	45.3		42.0		45.5	6.8		17.1	22.0	17.3
Progression Factor	1.00	1.00	1.00		1.00		1.00	1.00		1.00	1.00	1.00
Incremental Delay, d2	6.8	0.1	2.1		0.2		10.1	0.7		0.4	1.4	0.2
Delay (s)	53.1	41.7	47.3		42.2		55.7	7.4		17.4	23.4	17.6
Level of Service	D	D	D		D		E	A		B	C	B
Approach Delay (s)		48.3			42.2			24.3			22.6	
Approach LOS		D			D			C			C	

Intersection Summary

HCM 2000 Control Delay	29.5	HCM 2000 Level of Service	C
HCM 2000 Volume to Capacity ratio	0.61		
Actuated Cycle Length (s)	119.9	Sum of lost time (s)	18.0
Intersection Capacity Utilization	75.3%	ICU Level of Service	D
Analysis Period (min)	15		
c Critical Lane Group			

HCM Unsignalized Intersection Capacity Analysis

7: CO 83 & Private Drive

09/01/2021



Movement	WBL	WBR	NBT	NBR	SBL	SBT
Lane Configurations						
Traffic Volume (veh/h)	10	10	1045	5	5	920
Future Volume (Veh/h)	10	10	1045	5	5	920
Sign Control	Stop		Free		Free	
Grade	0%		0%		0%	
Peak Hour Factor	0.25	0.25	0.91	0.91	0.94	0.94
Hourly flow rate (vph)	40	40	1148	5	5	979
Pedestrians						
Lane Width (ft)						
Walking Speed (ft/s)						
Percent Blockage						
Right turn flare (veh)						
Median type	None			None		
Median storage (veh)						
Upstream signal (ft)						
pX, platoon unblocked						
vC, conflicting volume	1650	576			1153	
vC1, stage 1 conf vol						
vC2, stage 2 conf vol						
vCu, unblocked vol	1650	576			1153	
tC, single (s)	7.1	7.2			4.4	
tC, 2 stage (s)						
tF (s)	3.6	3.4			2.3	
p0 queue free %	50	91			99	
cM capacity (veh/h)	79	433			543	
Direction, Lane #	WB 1	NB 1	NB 2	SB 1	SB 2	SB 3
Volume Total	80	765	388	5	490	490
Volume Left	40	0	0	5	0	0
Volume Right	40	0	5	0	0	0
cSH	134	1700	1700	543	1700	1700
Volume to Capacity	0.60	0.45	0.23	0.01	0.29	0.29
Queue Length 95th (ft)	76	0	0	1	0	0
Control Delay (s)	65.4	0.0	0.0	11.7	0.0	0.0
Lane LOS	F			B		
Approach Delay (s)	65.4	0.0			0.1	
Approach LOS	F					
Intersection Summary						
Average Delay			2.4			
Intersection Capacity Utilization			39.0%	ICU Level of Service	A	
Analysis Period (min)	15					

HCM Unsignalized Intersection Capacity Analysis

8: CO 83 & Old North Gate Rd

09/01/2021



Movement	EBL	EBR	NBL	NBT	SBT	SBR
Lane Configurations						
Traffic Volume (veh/h)	5	125	225	860	760	5
Future Volume (Veh/h)	5	125	225	860	760	5
Sign Control	Stop			Free	Free	
Grade	0%			0%	0%	
Peak Hour Factor	0.78	0.78	0.91	0.91	0.94	0.94
Hourly flow rate (vph)	6	160	247	945	809	5
Pedestrians						
Lane Width (ft)						
Walking Speed (ft/s)						
Percent Blockage						
Right turn flare (veh)	2					
Median type				None	None	
Median storage (veh)						
Upstream signal (ft)						
pX, platoon unblocked						
vC, conflicting volume	1778	407	814			
vC1, stage 1 conf vol						
vC2, stage 2 conf vol						
vCu, unblocked vol	1778	407	814			
tC, single (s)	7.1	7.2	4.4			
tC, 2 stage (s)						
tF (s)	3.6	3.4	2.3			
p0 queue free %	86	72	67			
cM capacity (veh/h)	44	564	742			
Direction, Lane #	EB 1	NB 1	NB 2	NB 3	SB 1	SB 2
Volume Total	166	247	472	472	539	275
Volume Left	6	247	0	0	0	0
Volume Right	160	0	0	0	0	5
cSH	585	742	1700	1700	1700	1700
Volume to Capacity	0.28	0.33	0.28	0.28	0.32	0.16
Queue Length 95th (ft)	29	37	0	0	0	0
Control Delay (s)	17.0	12.3	0.0	0.0	0.0	0.0
Lane LOS	C	B				
Approach Delay (s)	17.0	2.5	0.0			
Approach LOS	C					
Intersection Summary						
Average Delay	2.7					
Intersection Capacity Utilization	47.0%			ICU Level of Service		A
Analysis Period (min)	15					

Intersection Sign configuration not allowed in HCM analysis.

HCM Unsignalized Intersection Capacity Analysis
 10: Shamrock Ranch Rd & CO 83

09/01/2021



Movement	EBT	EBR	WBL	WBT	NWL	NWR
Lane Configurations	↑↑			↑↑	↑↑	
Traffic Volume (veh/h)	850	20	10	775	10	5
Future Volume (Veh/h)	850	20	10	775	10	5
Sign Control	Free			Free	Stop	
Grade	0%			0%	0%	
Peak Hour Factor	0.91	0.91	0.93	0.93	0.92	0.92
Hourly flow rate (vph)	934	22	11	833	11	5
Pedestrians						
Lane Width (ft)						
Walking Speed (ft/s)						
Percent Blockage						
Right turn flare (veh)						
Median type	None			None		
Median storage (veh)						
Upstream signal (ft)						
pX, platoon unblocked						
vC, conflicting volume			956		1384	478
vC1, stage 1 conf vol						
vC2, stage 2 conf vol						
vCu, unblocked vol			956		1384	478
tC, single (s)			4.4		7.1	7.2
tC, 2 stage (s)						
tF (s)			2.3		3.6	3.4
p0 queue free %			98		91	99
cM capacity (veh/h)			651		120	505
Direction, Lane #	EB 1	EB 2	WB 1	WB 2	NW 1	
Volume Total	623	333	289	555	16	
Volume Left	0	0	11	0	11	
Volume Right	0	22	0	0	5	
cSH	1700	1700	651	1700	157	
Volume to Capacity	0.37	0.20	0.02	0.33	0.10	
Queue Length 95th (ft)	0	0	1	0	8	
Control Delay (s)	0.0	0.0	0.6	0.0	30.4	
Lane LOS	A			D		
Approach Delay (s)	0.0		0.2		30.4	
Approach LOS				D		
Intersection Summary						
Average Delay			0.4			
Intersection Capacity Utilization			38.5%	ICU Level of Service	A	
Analysis Period (min)			15			

HCM Unsignalized Intersection Capacity Analysis

11: CO 83 & Kaessner Lane





















09/01/2021



Movement	EBL	EBR	NBL	NBT	SBT	SBR
Lane Configurations						
Traffic Volume (veh/h)	5	10	10	845	765	5
Future Volume (Veh/h)	5	10	10	845	765	5
Sign Control	Stop			Free	Free	
Grade	0%			0%	0%	
Peak Hour Factor	0.44	0.44	0.92	0.92	0.91	0.91
Hourly flow rate (vph)	11	23	11	918	841	5
Pedestrians						
Lane Width (ft)						
Walking Speed (ft/s)						
Percent Blockage						
Right turn flare (veh)						
Median type				None	None	
Median storage (veh)						
Upstream signal (ft)						
pX, platoon unblocked						
vC, conflicting volume	1324	423	846			
vC1, stage 1 conf vol						
vC2, stage 2 conf vol						
vCu, unblocked vol	1324	423	846			
tC, single (s)	7.1	7.2	4.4			
tC, 2 stage (s)						
tF (s)	3.6	3.4	2.3			
p0 queue free %	92	96	98			
cM capacity (veh/h)	132	550	720			
Direction, Lane #	EB 1	NB 1	NB 2	SB 1	SB 2	
Volume Total	34	317	612	561	285	
Volume Left	11	11	0	0	0	
Volume Right	23	0	0	0	5	
cSH	271	720	1700	1700	1700	
Volume to Capacity	0.13	0.02	0.36	0.33	0.17	
Queue Length 95th (ft)	11	1	0	0	0	
Control Delay (s)	20.2	0.5	0.0	0.0	0.0	
Lane LOS	C	A				
Approach Delay (s)	20.2	0.2		0.0		
Approach LOS	C					
Intersection Summary						
Average Delay	0.5					
Intersection Capacity Utilization	40.4%			ICU Level of Service	A	
Analysis Period (min)	15					

HCM Signalized Intersection Capacity Analysis
 12: CO 83 & Stagecoach Rd

09/01/2021

												
Movement	EBL	EBT	EBR	WBL	WBT	WBR	NBL	NBT	NBR	SBL	SBT	SBR
Lane Configurations												
Traffic Volume (vph)	1	0	5	110	5	55	5	775	115	65	655	1
Future Volume (vph)	1	0	5	110	5	55	5	775	115	65	655	1
Ideal Flow (vphpl)	1900	1900	1900	1900	1900	1900	1900	1900	1900	1900	1900	1900
Total Lost time (s)		4.5			4.5	4.5	4.5	4.5	4.5	4.5	4.5	
Lane Util. Factor		1.00			1.00	1.00	1.00	0.95	1.00	1.00	0.95	
Frt		0.89			1.00	0.85	1.00	1.00	0.85	1.00	1.00	
Flt Protected		0.99			0.95	1.00	0.95	1.00	1.00	0.95	1.00	
Satd. Flow (prot)		1480			1605	1429	1597	3195	1429	1597	3194	
Flt Permitted		0.96			0.73	1.00	0.37	1.00	1.00	0.28	1.00	
Satd. Flow (perm)		1439			1222	1429	625	3195	1429	463	3194	
Peak-hour factor, PHF	0.50	0.50	0.50	0.83	0.83	0.83	0.90	0.90	0.90	0.89	0.89	0.89
Adj. Flow (vph)	2	0	10	133	6	66	6	861	128	73	736	1
RTOR Reduction (vph)	0	10	0	0	0	55	0	0	44	0	0	0
Lane Group Flow (vph)	0	2	0	0	139	11	6	861	84	73	737	0
Turn Type	Perm	NA		Perm	NA	Perm	Perm	NA	Perm	pm+pt	NA	
Protected Phases		4			8			2		1	6	
Permitted Phases	4			8		8	2		2	6		
Actuated Green, G (s)		17.3			17.3	17.3	71.0	71.0	71.0	81.3	81.3	
Effective Green, g (s)		17.3			17.3	17.3	71.0	71.0	71.0	81.3	81.3	
Actuated g/C Ratio		0.16			0.16	0.16	0.66	0.66	0.66	0.76	0.76	
Clearance Time (s)		4.5			4.5	4.5	4.5	4.5	4.5	4.5	4.5	
Vehicle Extension (s)		3.0			3.0	3.0	3.0	3.0	3.0	3.0	3.0	
Lane Grp Cap (vph)		231			196	229	412	2108	942	410	2413	
v/s Ratio Prot								c0.27		0.01	c0.23	
v/s Ratio Perm		0.00			c0.11	0.01	0.01		0.06	0.12		
v/c Ratio		0.01			0.71	0.05	0.01	0.41	0.09	0.18	0.31	
Uniform Delay, d1		37.9			42.8	38.2	6.3	8.5	6.6	4.2	4.2	
Progression Factor		1.00			1.00	1.00	1.00	1.00	1.00	1.00	1.00	
Incremental Delay, d2		0.0			11.1	0.1	0.1	0.6	0.2	0.2	0.3	
Delay (s)		38.0			53.9	38.3	6.3	9.1	6.8	4.4	4.5	
Level of Service		D			D	D	A	A	A	A	A	
Approach Delay (s)		38.0			48.9			8.8			4.5	
Approach LOS		D			D			A			A	
Intersection Summary												
HCM 2000 Control Delay			11.3		HCM 2000 Level of Service					B		
HCM 2000 Volume to Capacity ratio			0.46									
Actuated Cycle Length (s)			107.6		Sum of lost time (s)					13.5		
Intersection Capacity Utilization			49.9%		ICU Level of Service					A		
Analysis Period (min)			15									

c Critical Lane Group

HCM Unsignalized Intersection Capacity Analysis

13: CO 83 & Private Access

09/01/2021

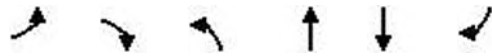

Movement	EBL	EBR	NBL	NBT	SBT	SBR
Lane Configurations						
Traffic Volume (veh/h)	5	0	10	830	720	5
Future Volume (Veh/h)	5	0	10	830	720	5
Sign Control	Stop			Free	Free	
Grade	0%			0%	0%	
Peak Hour Factor	0.25	0.25	0.90	0.90	0.87	0.87
Hourly flow rate (vph)	20	0	11	922	828	6
Pedestrians						
Lane Width (ft)						
Walking Speed (ft/s)						
Percent Blockage						
Right turn flare (veh)						
Median type				None	None	
Median storage (veh)						
Upstream signal (ft)	1248					
pX, platoon unblocked	0.89					
vC, conflicting volume	1314	417	834			
vC1, stage 1 conf vol						
vC2, stage 2 conf vol						
vCu, unblocked vol	1103	417	834			
tC, single (s)	7.1	7.2	4.4			
tC, 2 stage (s)						
tF (s)	3.6	3.4	2.3			
p0 queue free %	88	100	98			
cM capacity (veh/h)	165	555	728			
Direction, Lane #	EB 1	NB 1	NB 2	SB 1	SB 2	
Volume Total	20	318	615	552	282	
Volume Left	20	11	0	0	0	
Volume Right	0	0	0	0	6	
cSH	165	728	1700	1700	1700	
Volume to Capacity	0.12	0.02	0.36	0.32	0.17	
Queue Length 95th (ft)	10	1	0	0	0	
Control Delay (s)	29.7	0.5	0.0	0.0	0.0	
Lane LOS	D	A				
Approach Delay (s)	29.7	0.2		0.0		
Approach LOS	D					
Intersection Summary						
Average Delay	0.4					
Intersection Capacity Utilization	40.0%			ICU Level of Service	A	
Analysis Period (min)	15					

HCM Unsignalized Intersection Capacity Analysis

14: CO 83 & Benet Lane

09/01/2021



Movement	EBL	EBR	NBL	NBT	SBT	SBR
Lane Configurations						
Traffic Volume (veh/h)	10	10	10	825	710	5
Future Volume (Veh/h)	10	10	10	825	710	5
Sign Control	Stop			Free	Free	
Grade	0%			0%	0%	
Peak Hour Factor	0.50	0.50	0.90	0.90	0.89	0.89
Hourly flow rate (vph)	20	20	11	917	798	6
Pedestrians						
Lane Width (ft)						
Walking Speed (ft/s)						
Percent Blockage						
Right turn flare (veh)						
Median type				None	None	
Median storage (veh)						
Upstream signal (ft)						
pX, platoon unblocked						
vC, conflicting volume	1282	402	804			
vC1, stage 1 conf vol						
vC2, stage 2 conf vol						
vCu, unblocked vol	1282	402	804			
tC, single (s)	7.1	7.2	4.4			
tC, 2 stage (s)						
tF (s)	3.6	3.4	2.3			
p0 queue free %	86	96	99			
cM capacity (veh/h)	141	568	748			
Direction, Lane #	EB 1	NB 1	NB 2	NB 3	SB 1	SB 2
Volume Total	40	11	458	458	532	272
Volume Left	20	11	0	0	0	0
Volume Right	20	0	0	0	0	6
cSH	226	748	1700	1700	1700	1700
Volume to Capacity	0.18	0.01	0.27	0.27	0.31	0.16
Queue Length 95th (ft)	16	1	0	0	0	0
Control Delay (s)	24.3	9.9	0.0	0.0	0.0	0.0
Lane LOS	C	A				
Approach Delay (s)	24.3	0.1	0.0			
Approach LOS	C					
Intersection Summary						
Average Delay			0.6			
Intersection Capacity Utilization			32.8%	ICU Level of Service	A	
Analysis Period (min)			15			

HCM Unsignalized Intersection Capacity Analysis

15: CO 83 & High Forest Rd

09/01/2021



Movement	WBL	WBR	NBT	NBR	SBL	SBT	
Lane Configurations	↔		↕↕	↗	↖	↕↕	
Traffic Volume (veh/h)	45	10	775	60	5	670	
Future Volume (Veh/h)	45	10	775	60	5	670	
Sign Control	Stop		Free		Free		
Grade	0%		0%		0%		
Peak Hour Factor	0.66	0.66	0.93	0.93	0.89	0.89	
Hourly flow rate (vph)	68	15	833	65	6	753	
Pedestrians							
Lane Width (ft)							
Walking Speed (ft/s)							
Percent Blockage							
Right turn flare (veh)							
Median type	None			None			
Median storage (veh)							
Upstream signal (ft)							
pX, platoon unblocked							
vC, conflicting volume	1222	416			898		
vC1, stage 1 conf vol							
vC2, stage 2 conf vol							
vCu, unblocked vol	1222	416			898		
tC, single (s)	7.1	7.2			4.4		
tC, 2 stage (s)							
tF (s)	3.6	3.4			2.3		
p0 queue free %	56	97			99		
cM capacity (veh/h)	156	555			687		
Direction, Lane #	WB 1	NB 1	NB 2	NB 3	SB 1	SB 2	SB 3
Volume Total	83	416	416	65	6	376	376
Volume Left	68	0	0	0	6	0	0
Volume Right	15	0	0	65	0	0	0
cSH	179	1700	1700	1700	687	1700	1700
Volume to Capacity	0.46	0.24	0.24	0.04	0.01	0.22	0.22
Queue Length 95th (ft)	55	0	0	0	1	0	0
Control Delay (s)	41.4	0.0	0.0	0.0	10.3	0.0	0.0
Lane LOS	E			B			
Approach Delay (s)	41.4	0.0			0.1		
Approach LOS	E						
Intersection Summary							
Average Delay			2.0				
Intersection Capacity Utilization			31.4%		ICU Level of Service		A
Analysis Period (min)			15				

HCM Unsignalized Intersection Capacity Analysis
 16: CO 83 & Arena Rd

09/01/2021



Movement	EBL	EBR	NBL	NBT	SBT	SBR
Lane Configurations						
Traffic Volume (veh/h)	5	5	5	780	685	5
Future Volume (Veh/h)	5	5	5	780	685	5
Sign Control	Stop			Free	Free	
Grade	0%			0%	0%	
Peak Hour Factor	0.75	0.75	0.95	0.95	0.92	0.92
Hourly flow rate (vph)	7	7	5	821	745	5
Pedestrians						
Lane Width (ft)						
Walking Speed (ft/s)						
Percent Blockage						
Right turn flare (veh)						
Median type				None	None	
Median storage (veh)						
Upstream signal (ft)						
pX, platoon unblocked						
vC, conflicting volume	1168	375	750			
vC1, stage 1 conf vol						
vC2, stage 2 conf vol						
vCu, unblocked vol	1168	375	750			
tC, single (s)	7.1	7.2	4.4			
tC, 2 stage (s)						
tF (s)	3.6	3.4	2.3			
p0 queue free %	96	99	99			
cM capacity (veh/h)	170	592	786			
Direction, Lane #	EB 1	NB 1	NB 2	SB 1	SB 2	
Volume Total	14	279	547	497	253	
Volume Left	7	5	0	0	0	
Volume Right	7	0	0	0	5	
cSH	264	786	1700	1700	1700	
Volume to Capacity	0.05	0.01	0.32	0.29	0.15	
Queue Length 95th (ft)	4	0	0	0	0	
Control Delay (s)	19.4	0.2	0.0	0.0	0.0	
Lane LOS	C	A				
Approach Delay (s)	19.4	0.1		0.0		
Approach LOS	C					
Intersection Summary						
Average Delay	0.2					
Intersection Capacity Utilization	35.1%			ICU Level of Service	A	
Analysis Period (min)	15					

HCM Signalized Intersection Capacity Analysis

17: CO 83 & Hogden Rd

09/01/2021

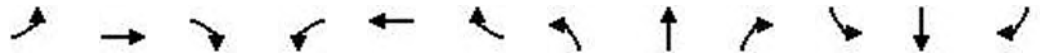

Movement	EBL	EBT	EBR	WBL	WBT	WBR	NBL	NBT	NBR	SBL	SBT	SBR
Lane Configurations												
Traffic Volume (vph)	45	245	75	180	135	180	105	420	260	390	442	75
Future Volume (vph)	45	245	75	180	135	180	105	420	260	390	442	75
Ideal Flow (vphpl)	1900	1900	1900	1900	1900	1900	1900	1900	1900	1900	1900	1900
Total Lost time (s)	6.0	6.0	6.0	6.0	6.0	6.0	6.0	7.0	7.0	6.0	7.0	
Lane Util. Factor	1.00	1.00	1.00	1.00	1.00	1.00	1.00	1.00	1.00	1.00	1.00	
Frt	1.00	1.00	0.85	1.00	1.00	0.85	1.00	1.00	0.85	1.00	0.98	
Flt Protected	0.95	1.00	1.00	0.95	1.00	1.00	0.95	1.00	1.00	0.95	1.00	
Satd. Flow (prot)	1597	1681	1429	1597	1681	1429	1597	1681	1429	1597	1645	
Flt Permitted	0.95	1.00	1.00	0.95	1.00	1.00	0.36	1.00	1.00	0.17	1.00	
Satd. Flow (perm)	1597	1681	1429	1597	1681	1429	613	1681	1429	294	1645	
Peak-hour factor, PHF	0.92	0.92	0.92	0.79	0.79	0.79	0.95	0.95	0.95	0.89	0.89	0.89
Adj. Flow (vph)	49	266	82	228	171	228	111	442	274	438	497	84
RTOR Reduction (vph)	0	0	69	0	0	194	0	0	191	0	5	0
Lane Group Flow (vph)	49	266	13	228	171	34	111	442	83	438	576	0
Turn Type	Split	NA	Perm	Split	NA	Perm	pm+pt	NA	Perm	pm+pt	NA	
Protected Phases	4	4		8	8		5	2		1	6	
Permitted Phases			4			8	2		2	6		
Actuated Green, G (s)	21.0	21.0	21.0	19.0	19.0	19.0	43.7	37.7	37.7	69.7	57.7	
Effective Green, g (s)	21.0	21.0	21.0	19.0	19.0	19.0	43.7	37.7	37.7	69.7	57.7	
Actuated g/C Ratio	0.16	0.16	0.16	0.15	0.15	0.15	0.34	0.29	0.29	0.54	0.45	
Clearance Time (s)	6.0	6.0	6.0	6.0	6.0	6.0	6.0	7.0	7.0	6.0	7.0	
Vehicle Extension (s)	3.0	3.0	3.0	3.0	3.0	3.0	3.0	3.0	3.0	3.0	3.0	
Lane Grp Cap (vph)	260	274	233	235	248	210	254	492	418	422	737	
v/s Ratio Prot	0.03	c0.16		c0.14	0.10		0.02	0.26		c0.21	0.35	
v/s Ratio Perm			0.01			0.02	0.13		0.06	c0.35		
v/c Ratio	0.19	0.97	0.06	0.97	0.69	0.16	0.44	0.90	0.20	1.04	0.78	
Uniform Delay, d1	46.5	53.5	45.5	54.6	52.1	47.9	30.7	43.7	34.2	32.5	30.1	
Progression Factor	1.00	1.00	1.00	1.00	1.00	1.00	1.00	1.00	1.00	1.00	1.00	
Incremental Delay, d2	0.4	46.1	0.1	50.1	7.8	0.4	1.2	18.9	0.2	54.0	5.4	
Delay (s)	46.8	99.7	45.6	104.7	59.8	48.2	31.9	62.5	34.4	86.5	35.6	
Level of Service	D	F	D	F	E	D	C	E	C	F	D	
Approach Delay (s)		82.0			71.9			49.1			57.4	
Approach LOS		F			E			D			E	

Intersection Summary

HCM 2000 Control Delay	61.6	HCM 2000 Level of Service	E
HCM 2000 Volume to Capacity ratio	1.04		
Actuated Cycle Length (s)	128.7	Sum of lost time (s)	25.0
Intersection Capacity Utilization	94.5%	ICU Level of Service	F
Analysis Period (min)	15		

c Critical Lane Group

HCM Unsignalized Intersection Capacity Analysis

18: CO 83 & Walden Way

09/01/2021



Movement	WBL	WBR	NBT	NBR	SBL	SBT
Lane Configurations						
Traffic Volume (veh/h)	5	15	705	10	10	915
Future Volume (Veh/h)	5	15	705	10	10	915
Sign Control	Stop		Free		Free	
Grade	0%		0%		0%	
Peak Hour Factor	0.75	0.75	0.76	0.76	0.93	0.93
Hourly flow rate (vph)	7	20	928	13	11	984
Pedestrians						
Lane Width (ft)						
Walking Speed (ft/s)						
Percent Blockage						
Right turn flare (veh)						
Median type	None			None		
Median storage (veh)						
Upstream signal (ft)						
pX, platoon unblocked						
vC, conflicting volume	1940	934			941	
vC1, stage 1 conf vol						
vC2, stage 2 conf vol						
vCu, unblocked vol	1940	934			941	
tC, single (s)	6.5	6.3			4.2	
tC, 2 stage (s)						
tF (s)	3.6	3.4			2.3	
p0 queue free %	89	93			98	
cM capacity (veh/h)	66	307			686	
Direction, Lane #	WB 1	NB 1	SB 1			
Volume Total	27	941	995			
Volume Left	7	0	11			
Volume Right	20	13	0			
cSH	158	1700	686			
Volume to Capacity	0.17	0.55	0.02			
Queue Length 95th (ft)	15	0	1			
Control Delay (s)	32.5	0.0	0.5			
Lane LOS	D		A			
Approach Delay (s)	32.5	0.0	0.5			
Approach LOS	D					
Intersection Summary						
Average Delay			0.7			
Intersection Capacity Utilization			66.1%	ICU Level of Service	C	
Analysis Period (min)			15			

HCM Signalized Intersection Capacity Analysis

19: CO 83 & CR 105/Walker Rd

09/01/2021

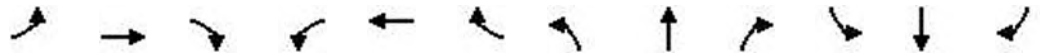

Movement	EBL	EBT	EBR	WBL	WBT	WBR	NBL	NBT	NBR	SBL	SBT	SBR
Lane Configurations												
Traffic Volume (vph)	240	145	85	95	155	40	235	405	65	35	745	120
Future Volume (vph)	240	145	85	95	155	40	235	405	65	35	745	120
Ideal Flow (vphpl)	1900	1900	1900	1900	1900	1900	1900	1900	1900	1900	1900	1900
Total Lost time (s)	4.5	6.0	4.0	4.5	6.0	6.0	5.0	7.0	7.0	5.0	7.0	7.0
Lane Util. Factor	1.00	0.95	1.00	1.00	0.95	1.00	1.00	1.00	1.00	1.00	1.00	1.00
Frt	1.00	1.00	0.85	1.00	1.00	0.85	1.00	1.00	0.85	1.00	1.00	0.85
Flt Protected	0.95	1.00	1.00	0.95	1.00	1.00	0.95	1.00	1.00	0.95	1.00	1.00
Satd. Flow (prot)	1597	3195	1429	1597	3195	1429	1597	1681	1429	1597	1681	1429
Flt Permitted	0.38	1.00	1.00	0.65	1.00	1.00	0.12	1.00	1.00	0.47	1.00	1.00
Satd. Flow (perm)	641	3195	1429	1100	3195	1429	198	1681	1429	783	1681	1429
Peak-hour factor, PHF	0.94	0.94	0.94	0.61	0.61	0.61	0.82	0.82	0.82	0.95	0.95	0.95
Adj. Flow (vph)	255	154	90	156	254	66	287	494	79	37	784	126
RTOR Reduction (vph)	0	0	0	0	0	61	0	0	34	0	0	63
Lane Group Flow (vph)	255	154	90	156	254	5	287	494	45	37	784	63
Turn Type	pm+pt	NA	Free	pm+pt	NA	Perm	pm+pt	NA	Perm	pm+pt	NA	Perm
Protected Phases	7	4		3	8		5	2		1	6	
Permitted Phases	4		Free	8		8	2		2	6		6
Actuated Green, G (s)	22.4	10.5	108.3	17.6	8.1	8.1	70.8	62.3	62.3	57.3	53.8	53.8
Effective Green, g (s)	22.4	10.5	108.3	17.6	8.1	8.1	70.8	62.3	62.3	57.3	53.8	53.8
Actuated g/C Ratio	0.21	0.10	1.00	0.16	0.07	0.07	0.65	0.58	0.58	0.53	0.50	0.50
Clearance Time (s)	4.5	6.0		4.5	6.0	6.0	5.0	7.0	7.0	5.0	7.0	7.0
Vehicle Extension (s)	3.0	3.0		3.0	3.0	3.0	3.0	3.0	3.0	3.0	3.0	3.0
Lane Grp Cap (vph)	237	309	1429	222	238	106	284	967	822	440	835	709
v/s Ratio Prot	c0.12	0.05		0.06	0.08		c0.11	0.29		0.00	0.47	
v/s Ratio Perm	c0.10		0.06	0.05		0.00	c0.55		0.03	0.04		0.04
v/c Ratio	1.08	0.50	0.06	0.70	1.07	0.05	1.01	0.51	0.06	0.08	0.94	0.09
Uniform Delay, d1	41.2	46.4	0.0	42.1	50.1	46.5	28.2	13.8	10.1	12.3	25.7	14.3
Progression Factor	1.00	1.00	1.00	1.00	1.00	1.00	1.00	1.00	1.00	1.00	1.00	1.00
Incremental Delay, d2	80.1	1.3	0.1	9.7	77.3	0.2	56.1	0.5	0.0	0.1	17.8	0.1
Delay (s)	121.3	47.7	0.1	51.7	127.4	46.7	84.3	14.3	10.1	12.4	43.5	14.4
Level of Service	F	D	A	D	F	D	F	B	B	B	D	B
Approach Delay (s)		76.7			91.4			37.3			38.4	
Approach LOS		E			F			D			D	

Intersection Summary

HCM 2000 Control Delay	54.0	HCM 2000 Level of Service	D
HCM 2000 Volume to Capacity ratio	1.09		
Actuated Cycle Length (s)	108.3	Sum of lost time (s)	22.5
Intersection Capacity Utilization	89.3%	ICU Level of Service	E
Analysis Period (min)	15		

c Critical Lane Group

HCM Signalized Intersection Capacity Analysis
20: CO 83 & E Palmer Divide Ave

09/01/2021



Movement	EBL	EBT	EBR	WBL	WBT	WBR	NBL	NBT	NBR	SBL	SBT	SBR
Lane Configurations												
Traffic Volume (vph)	40	55	120	60	30	5	65	360	130	25	690	75
Future Volume (vph)	40	55	120	60	30	5	65	360	130	25	690	75
Ideal Flow (vphpl)	1900	1900	1900	1900	1900	1900	1900	1900	1900	1900	1900	1900
Total Lost time (s)	4.5	7.0	7.0	4.5	7.0	7.0	4.5	8.0		4.5	8.0	
Lane Util. Factor	1.00	1.00	1.00	1.00	1.00	1.00	1.00	1.00		1.00	1.00	
Frt	1.00	1.00	0.85	1.00	1.00	0.85	1.00	0.96		1.00	0.99	
Flt Protected	0.95	1.00	1.00	0.95	1.00	1.00	0.95	1.00		0.95	1.00	
Satd. Flow (prot)	1597	1681	1429	1597	1681	1429	1597	1614		1597	1657	
Flt Permitted	0.73	1.00	1.00	0.66	1.00	1.00	0.18	1.00		0.32	1.00	
Satd. Flow (perm)	1231	1681	1429	1110	1681	1429	305	1614		544	1657	
Peak-hour factor, PHF	0.88	0.88	0.88	0.78	0.78	0.78	0.78	0.78	0.78	0.94	0.94	0.94
Adj. Flow (vph)	45	62	136	77	38	6	83	462	167	27	734	80
RTOR Reduction (vph)	0	0	120	0	0	5	0	8	0	0	3	0
Lane Group Flow (vph)	45	63	16	77	38	1	83	621	0	27	811	0
Turn Type	pm+pt	NA	Perm	pm+pt	NA	Perm	pm+pt	NA		pm+pt	NA	
Protected Phases	7	4		3	8		5	2		1	6	
Permitted Phases	4		4	8		8	2			6		
Actuated Green, G (s)	14.7	11.9	11.9	16.7	12.9	12.9	62.3	58.5		60.3	57.5	
Effective Green, g (s)	14.7	11.9	11.9	16.7	12.9	12.9	62.3	58.5		60.3	57.5	
Actuated g/C Ratio	0.15	0.12	0.12	0.17	0.13	0.13	0.62	0.58		0.60	0.57	
Clearance Time (s)	4.5	7.0	7.0	4.5	7.0	7.0	4.5	8.0		4.5	8.0	
Vehicle Extension (s)	3.0	5.0	5.0	3.0	5.0	5.0	3.0	5.0		3.0	5.0	
Lane Grp Cap (vph)	189	198	168	201	214	182	236	934		353	943	
v/s Ratio Prot	0.01	0.04		c0.01	0.02		c0.01	0.38		0.00	c0.49	
v/s Ratio Perm	0.03		0.01	c0.05		0.00	0.20			0.04		
v/c Ratio	0.24	0.32	0.10	0.38	0.18	0.00	0.35	0.66		0.08	0.86	
Uniform Delay, d1	37.9	40.8	39.7	37.1	39.3	38.4	12.6	14.5		9.3	18.4	
Progression Factor	1.00	1.00	1.00	1.00	1.00	1.00	1.00	1.00		1.00	1.00	
Incremental Delay, d2	0.7	1.9	0.5	1.2	0.8	0.0	0.9	2.4		0.1	8.8	
Delay (s)	38.6	42.8	40.3	38.3	40.1	38.5	13.5	16.9		9.4	27.2	
Level of Service	D	D	D	D	D	D	B	B		A	C	
Approach Delay (s)		40.6			38.9			16.5			26.6	
Approach LOS		D			D			B			C	

Intersection Summary

HCM 2000 Control Delay	25.4	HCM 2000 Level of Service	C
HCM 2000 Volume to Capacity ratio	0.74		
Actuated Cycle Length (s)	101.0	Sum of lost time (s)	24.0
Intersection Capacity Utilization	71.3%	ICU Level of Service	C
Analysis Period (min)	15		

c Critical Lane Group

HCM Unsignalized Intersection Capacity Analysis
 43: CO 83 & Pinehurst RI only

09/01/2021



Movement	WBL	WBR	NBT	NBR	SBL	SBT
Lane Configurations			↑	↗		↑↑
Traffic Volume (veh/h)	0	0	705	45	0	925
Future Volume (Veh/h)	0	0	705	45	0	925
Sign Control	Stop		Free		Free	
Grade	0%		0%		0%	
Peak Hour Factor	0.92	0.92	0.92	0.92	0.92	0.92
Hourly flow rate (vph)	0	0	766	49	0	1005
Pedestrians						
Lane Width (ft)						
Walking Speed (ft/s)						
Percent Blockage						
Right turn flare (veh)						
Median type	None			None		
Median storage (veh)						
Upstream signal (ft)						
pX, platoon unblocked						
vC, conflicting volume	1268	766			815	
vC1, stage 1 conf vol						
vC2, stage 2 conf vol						
vCu, unblocked vol	1268	766			815	
tC, single (s)	7.1	7.2			4.4	
tC, 2 stage (s)						
tF (s)	3.6	3.4			2.3	
p0 queue free %	100	100			100	
cM capacity (veh/h)	146	322			741	
Direction, Lane #	NB 1	NB 2	SB 1	SB 2		
Volume Total	766	49	502	502		
Volume Left	0	0	0	0		
Volume Right	0	49	0	0		
cSH	1700	1700	1700	1700		
Volume to Capacity	0.45	0.03	0.30	0.30		
Queue Length 95th (ft)	0	0	0	0		
Control Delay (s)	0.0	0.0	0.0	0.0		
Lane LOS						
Approach Delay (s)	0.0		0.0			
Approach LOS						
Intersection Summary						
Average Delay			0.0			
Intersection Capacity Utilization			40.4%		ICU Level of Service	A
Analysis Period (min)			15			

D.3. 2045 with Recommended ACP Implemented

HCM Signalized Intersection Capacity Analysis

1: CO 83 & SO 21 SB

09/01/2021



Movement	SEL	SET	SER	NWL	NWT	NWR	NEL	NET	NER	SWL	SWT	SWR
Lane Configurations	↖↗		↖					↖↗↘	↖	↖↗	↖↗↘	
Traffic Volume (vph)	425	0	685	0	0	0	0	415	525	700	895	0
Future Volume (vph)	425	0	685	0	0	0	0	415	525	700	895	0
Ideal Flow (vphpl)	1900	1900	1900	1900	1900	1900	1900	1900	1900	1900	1900	1900
Total Lost time (s)	4.5		4.5					7.5	4.0	5.0	7.5	
Lane Util. Factor	0.97		1.00					0.91	1.00	0.97	0.91	
Frt	1.00		0.85					1.00	0.85	1.00	1.00	
Flt Protected	0.95		1.00					1.00	1.00	0.95	1.00	
Satd. Flow (prot)	3099		1429					4590	1429	3099	4590	
Flt Permitted	0.95		1.00					1.00	1.00	0.32	1.00	
Satd. Flow (perm)	3099		1429					4590	1429	1055	4590	
Peak-hour factor, PHF	0.92	0.92	0.92	0.92	0.92	0.92	0.92	0.86	0.86	0.91	0.91	0.92
Adj. Flow (vph)	462	0	745	0	0	0	0	483	610	769	984	0
RTOR Reduction (vph)	0	0	42	0	0	0	0	0	0	0	0	0
Lane Group Flow (vph)	462	0	703	0	0	0	0	483	610	769	984	0
Turn Type	Prot		Perm					NA	Free	pm+pt	NA	
Protected Phases	4							2		1	6	
Permitted Phases	4		4						Free	6		
Actuated Green, G (s)	62.2		62.2					22.8	124.0	49.8	49.8	
Effective Green, g (s)	62.2		62.2					22.8	124.0	49.8	49.8	
Actuated g/C Ratio	0.50		0.50					0.18	1.00	0.40	0.40	
Clearance Time (s)	4.5		4.5					7.5		5.0	7.5	
Vehicle Extension (s)	3.0		3.0					1.0		3.0	1.0	
Lane Grp Cap (vph)	1554		716					843	1429	786	1843	
v/s Ratio Prot	0.15							0.11		c0.17	0.21	
v/s Ratio Perm			c0.49						0.43	c0.22		
v/c Ratio	0.30		0.98					0.57	0.43	0.98	0.53	
Uniform Delay, d1	18.1		30.4					46.2	0.0	31.3	28.3	
Progression Factor	1.00		1.00					1.00	1.00	1.00	1.00	
Incremental Delay, d2	0.1		29.0					2.8	0.9	26.5	1.1	
Delay (s)	18.2		59.4					49.0	0.9	57.8	29.4	
Level of Service	B		E					D	A	E	C	
Approach Delay (s)		43.6			0.0			22.2			41.9	
Approach LOS		D			A			C			D	

Intersection Summary

HCM 2000 Control Delay	37.1	HCM 2000 Level of Service	D
HCM 2000 Volume to Capacity ratio	1.01		
Actuated Cycle Length (s)	124.0	Sum of lost time (s)	17.0
Intersection Capacity Utilization	71.2%	ICU Level of Service	C
Analysis Period (min)	15		

c Critical Lane Group

HCM Signalized Intersection Capacity Analysis

2: CO 83 & CO 21 NB

09/01/2021



Movement	SEL	SET	SER	NWL	NWT	NWR	NEL	NET	NER	SWL	SWT	SWR
Lane Configurations				↔↔		↗	↔↔	↕↕↕			↕↕↕	↗
Traffic Volume (vph)	0	0	0	815	0	330	300	540	0	0	780	400
Future Volume (vph)	0	0	0	815	0	330	300	540	0	0	780	400
Ideal Flow (vphpl)	1900	1900	1900	1900	1900	1900	1900	1900	1900	1900	1900	1900
Total Lost time (s)				6.5		4.0	4.5	7.5			6.5	6.5
Lane Util. Factor				0.97		1.00	0.97	0.91			0.91	1.00
Frt				1.00		0.85	1.00	1.00			1.00	0.85
Flt Protected				0.95		1.00	0.95	1.00			1.00	1.00
Satd. Flow (prot)				3099		1429	3099	4590			4590	1429
Flt Permitted				0.95		1.00	0.95	1.00			1.00	1.00
Satd. Flow (perm)				3099		1429	3099	4590			4590	1429
Peak-hour factor, PHF	0.92	0.92	0.92	0.88	0.92	0.88	0.92	0.69	0.69	0.90	0.90	0.92
Adj. Flow (vph)	0	0	0	926	0	375	326	783	0	0	867	435
RTOR Reduction (vph)	0	0	0	0	0	0	0	0	0	0	0	273
Lane Group Flow (vph)	0	0	0	926	0	375	326	783	0	0	867	162
Turn Type				Prot		Free	Prot	NA			NA	Perm
Protected Phases				4			5	2			6	
Permitted Phases				4		Free						6
Actuated Green, G (s)				40.7		120.0	17.2	65.3			44.6	44.6
Effective Green, g (s)				40.7		120.0	17.2	65.3			44.6	44.6
Actuated g/C Ratio				0.34		1.00	0.14	0.54			0.37	0.37
Clearance Time (s)				6.5			4.5	7.5			6.5	6.5
Vehicle Extension (s)				2.0			3.0	1.0			1.0	1.0
Lane Grp Cap (vph)				1051		1429	444	2497			1705	531
v/s Ratio Prot				c0.30			c0.11	0.17			c0.19	
v/s Ratio Perm						0.26						0.11
v/c Ratio				0.88		0.26	0.73	0.31			0.51	0.30
Uniform Delay, d1				37.4		0.0	49.2	15.0			29.2	26.7
Progression Factor				1.00		1.00	1.00	1.00			1.00	1.00
Incremental Delay, d2				8.6		0.4	6.2	0.3			1.1	1.5
Delay (s)				45.9		0.4	55.4	15.4			30.3	28.2
Level of Service				D		A	E	B			C	C
Approach Delay (s)		0.0			32.8			27.1			29.6	
Approach LOS		A			C			C			C	

Intersection Summary

HCM 2000 Control Delay	30.0	HCM 2000 Level of Service	C
HCM 2000 Volume to Capacity ratio	0.69		
Actuated Cycle Length (s)	120.0	Sum of lost time (s)	17.5
Intersection Capacity Utilization	71.2%	ICU Level of Service	C
Analysis Period (min)	15		

c Critical Lane Group

Intersection has too many lanes per leg.

HCM All-Way analysis is limited to two lanes per leg.

Channelized right turn lanes are not counted.

HCM Signalized Intersection Capacity Analysis

4: CO 83 & Shoup Road

09/01/2021

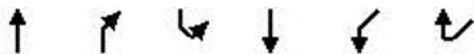

Movement	NBT	NBR	SBL	SBT	SWL	SWR
Lane Configurations	↑↑↑	↑	↙	↑↑↑	↙	↗
Traffic Volume (vph)	750	365	245	915	365	240
Future Volume (vph)	750	365	245	915	365	240
Ideal Flow (vphpl)	1900	1900	1900	1900	1900	1900
Total Lost time (s)	7.5	4.0	5.0	7.5	6.0	4.0
Lane Util. Factor	0.91	1.00	1.00	0.91	1.00	1.00
Frt	1.00	0.85	1.00	1.00	1.00	0.85
Flt Protected	1.00	1.00	0.95	1.00	0.95	1.00
Satd. Flow (prot)	4590	1429	1597	4590	1597	1429
Flt Permitted	1.00	1.00	0.23	1.00	0.95	1.00
Satd. Flow (perm)	4590	1429	393	4590	1597	1429
Peak-hour factor, PHF	0.87	0.87	0.86	0.86	0.82	0.82
Adj. Flow (vph)	862	420	285	1064	445	293
RTOR Reduction (vph)	0	0	0	0	0	0
Lane Group Flow (vph)	862	420	285	1064	445	293
Turn Type	NA	Free	pm+pt	NA	Prot	Free
Protected Phases	2		1	6	8	
Permitted Phases		Free	6			Free
Actuated Green, G (s)	38.5	103.7	57.3	57.3	32.9	103.7
Effective Green, g (s)	38.5	103.7	57.3	57.3	32.9	103.7
Actuated g/C Ratio	0.37	1.00	0.55	0.55	0.32	1.00
Clearance Time (s)	7.5		5.0	7.5	6.0	
Vehicle Extension (s)	1.0		1.0	1.0	3.0	
Lane Grp Cap (vph)	1704	1429	377	2536	506	1429
v/s Ratio Prot	0.19		c0.10	0.23	c0.28	
v/s Ratio Perm		0.29	c0.32			0.21
v/c Ratio	0.51	0.29	0.76	0.42	0.88	0.21
Uniform Delay, d1	25.2	0.0	14.0	13.5	33.5	0.0
Progression Factor	1.00	1.00	1.00	1.00	1.00	1.00
Incremental Delay, d2	1.1	0.5	7.5	0.5	15.9	0.3
Delay (s)	26.3	0.5	21.5	14.0	49.4	0.3
Level of Service	C	A	C	B	D	A
Approach Delay (s)	17.9			15.6	29.9	
Approach LOS	B			B	C	

Intersection Summary

HCM 2000 Control Delay	19.6	HCM 2000 Level of Service	B
HCM 2000 Volume to Capacity ratio	0.83		
Actuated Cycle Length (s)	103.7	Sum of lost time (s)	18.5
Intersection Capacity Utilization	65.9%	ICU Level of Service	C
Analysis Period (min)	15		

c Critical Lane Group

HCM Signalized Intersection Capacity Analysis
5: CO 83 & Flying Horse Club Dr/Abert Way

09/01/2021

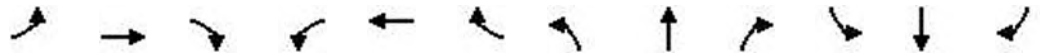

Movement	EBL	EBT	EBR	WBL	WBT	WBR	NBL	NBT	NBR	SBL	SBT	SBR
Lane Configurations	↘	↑	↗	↘	↗		↘	↑↑↑		↘	↑↑↑	↗
Traffic Volume (vph)	155	0	290	10	5	5	255	735	5	5	890	140
Future Volume (vph)	155	0	290	10	5	5	255	735	5	5	890	140
Ideal Flow (vphpl)	1900	1900	1900	1900	1900	1900	1900	1900	1900	1900	1900	1900
Total Lost time (s)	7.0		7.0	7.0	7.0		7.0	8.0		7.0	8.0	8.0
Lane Util. Factor	1.00		1.00	1.00	1.00		1.00	0.91		1.00	0.91	1.00
Frbp, ped/bikes	1.00		1.00	1.00	1.00		1.00	1.00		1.00	1.00	1.00
Flpb, ped/bikes	1.00		1.00	1.00	1.00		1.00	1.00		1.00	1.00	1.00
Frt	1.00		0.85	1.00	0.93		1.00	1.00		1.00	1.00	0.85
Flt Protected	0.95		1.00	0.95	1.00		0.95	1.00		0.95	1.00	1.00
Satd. Flow (prot)	1597		1429	1597	1555		1597	4584		1596	4590	1429
Flt Permitted	0.74		1.00	0.76	1.00		0.17	1.00		0.33	1.00	1.00
Satd. Flow (perm)	1249		1429	1273	1555		288	4584		553	4590	1429
Peak-hour factor, PHF	0.75	0.75	0.75	0.44	0.44	0.44	0.90	0.90	0.90	0.83	0.83	0.83
Adj. Flow (vph)	207	0	387	23	11	11	283	817	6	6	1072	169
RTOR Reduction (vph)	0	0	287	0	9	0	0	0	0	0	0	100
Lane Group Flow (vph)	207	0	100	23	13	0	283	823	0	6	1072	69
Confl. Peds. (#/hr)									6	6		
Turn Type	Perm		Perm	Perm	NA		pm+pt	NA		pm+pt	NA	Perm
Protected Phases		4			8		5	2		1	6	
Permitted Phases	4		4	8			2			6		6
Actuated Green, G (s)	21.2		21.2	21.2	21.2		68.7	60.9		43.6	42.8	42.8
Effective Green, g (s)	21.2		21.2	21.2	21.2		68.7	60.9		43.6	42.8	42.8
Actuated g/C Ratio	0.20		0.20	0.20	0.20		0.65	0.58		0.42	0.41	0.41
Clearance Time (s)	7.0		7.0	7.0	7.0		7.0	8.0		7.0	8.0	8.0
Vehicle Extension (s)	3.0		3.0	3.0	3.0		3.0	3.0		3.0	3.0	3.0
Lane Grp Cap (vph)	252		288	257	314		424	2661		237	1872	583
v/s Ratio Prot					0.01		c0.12	0.18		0.00	0.23	
v/s Ratio Perm	c0.17		0.07	0.02			c0.32			0.01		0.05
v/c Ratio	0.82		0.35	0.09	0.04		0.67	0.31		0.03	0.57	0.12
Uniform Delay, d1	40.0		35.9	34.0	33.7		11.3	11.2		18.0	24.0	19.3
Progression Factor	1.00		1.00	1.00	1.00		1.00	1.00		1.00	1.00	1.00
Incremental Delay, d2	18.9		0.7	0.2	0.1		4.0	0.1		0.0	0.4	0.1
Delay (s)	59.0		36.6	34.2	33.7		15.3	11.3		18.0	24.4	19.4
Level of Service	E		D	C	C		B	B		B	C	B
Approach Delay (s)		44.4			34.0			12.3			23.7	
Approach LOS		D			C			B			C	

Intersection Summary

HCM 2000 Control Delay	23.8	HCM 2000 Level of Service	C
HCM 2000 Volume to Capacity ratio	0.73		
Actuated Cycle Length (s)	104.9	Sum of lost time (s)	22.0
Intersection Capacity Utilization	76.9%	ICU Level of Service	D
Analysis Period (min)	15		
c Critical Lane Group			

HCM Signalized Intersection Capacity Analysis

6: CO 83 & North Gate Blvd

09/01/2021

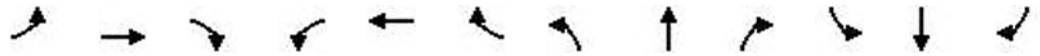

Movement	EBL	EBT	EBR	WBL	WBT	WBR	NBL	NBT	NBR	SBL	SBT	SBR
Lane Configurations												
Traffic Volume (vph)	60	5	325	20	5	10	550	350	11	5	750	115
Future Volume (vph)	60	5	325	20	5	10	550	350	11	5	750	115
Ideal Flow (vphpl)	1900	1900	1900	1900	1900	1900	1900	1900	1900	1900	1900	1900
Total Lost time (s)	6.0	6.0	6.0		6.0		5.0	7.0		7.0	7.0	7.0
Lane Util. Factor	1.00	1.00	1.00		1.00		0.97	0.95		1.00	0.95	1.00
Frbp, ped/bikes	1.00	1.00	1.00		1.00		1.00	1.00		1.00	1.00	1.00
Flpb, ped/bikes	1.00	1.00	1.00		1.00		1.00	1.00		1.00	1.00	1.00
Frt	1.00	1.00	0.85		0.96		1.00	1.00		1.00	1.00	0.85
Flt Protected	0.95	1.00	1.00		0.97		0.95	1.00		0.95	1.00	1.00
Satd. Flow (prot)	1438	1513	1286		1414		2789	2860		1433	2875	1286
Flt Permitted	0.63	1.00	1.00		0.82		0.95	1.00		0.51	1.00	1.00
Satd. Flow (perm)	952	1513	1286		1193		2789	2860		768	2875	1286
Peak-hour factor, PHF	0.84	0.84	0.84	0.25	0.25	0.25	0.87	0.87	0.87	0.89	0.89	0.89
Adj. Flow (vph)	71	6	387	80	20	40	632	402	13	6	843	129
RTOR Reduction (vph)	0	0	331	0	10	0	0	1	0	0	0	69
Lane Group Flow (vph)	71	6	56	0	130	0	632	414	0	6	843	60
Confl. Peds. (#/hr)									3	3		
Turn Type	Perm	NA	Perm	Perm	NA		Prot	NA		Perm	NA	Perm
Protected Phases		4			8		5	2			6	
Permitted Phases	4		4	8						6		6
Actuated Green, G (s)	19.9	19.9	19.9		19.9		35.6	105.2		64.6	64.6	64.6
Effective Green, g (s)	19.9	19.9	19.9		19.9		35.6	105.2		64.6	64.6	64.6
Actuated g/C Ratio	0.14	0.14	0.14		0.14		0.26	0.76		0.47	0.47	0.47
Clearance Time (s)	6.0	6.0	6.0		6.0		5.0	7.0		7.0	7.0	7.0
Vehicle Extension (s)	3.0	3.0	3.0		3.0		3.0	3.0		3.0	3.0	3.0
Lane Grp Cap (vph)	137	218	185		171		718	2178		359	1344	601
v/s Ratio Prot		0.00					c0.23	0.14			c0.29	
v/s Ratio Perm	0.07		0.04		c0.11					0.01		0.05
v/c Ratio	0.52	0.03	0.30		0.76		0.88	0.19		0.02	0.63	0.10
Uniform Delay, d1	54.7	50.8	52.9		56.8		49.2	4.6		19.7	27.7	20.5
Progression Factor	1.00	1.00	1.00		1.00		1.00	1.00		1.00	1.00	1.00
Incremental Delay, d2	3.3	0.1	0.9		17.4		12.1	0.2		0.1	2.2	0.3
Delay (s)	58.0	50.8	53.8		74.2		61.4	4.8		19.8	29.9	20.9
Level of Service	E	D	D		E		E	A		B	C	C
Approach Delay (s)		54.4			74.2			38.9			28.6	
Approach LOS		D			E			D			C	

Intersection Summary

HCM 2000 Control Delay	39.7	HCM 2000 Level of Service	D
HCM 2000 Volume to Capacity ratio	0.72		
Actuated Cycle Length (s)	138.1	Sum of lost time (s)	18.0
Intersection Capacity Utilization	66.2%	ICU Level of Service	C
Analysis Period (min)	15		
c Critical Lane Group			

HCM Signalized Intersection Capacity Analysis

7: CO 83 & Old North Gate Rd

09/01/2021



Movement	EBL	EBT	EBR	WBL	WBT	WBR	NBL	NBT	NBR	SBL	SBT	SBR
Lane Configurations												
Traffic Volume (vph)	20	0	210	25	5	30	90	465	5	5	755	21
Future Volume (vph)	20	0	210	25	5	30	90	465	5	5	755	21
Ideal Flow (vphpl)	1900	1900	1900	1900	1900	1900	1900	1900	1900	1900	1900	1900
Total Lost time (s)	6.0	6.0		6.0	6.0		5.0	7.0	7.0	7.0	7.0	7.0
Lane Util. Factor	1.00	1.00		1.00	1.00		1.00	0.95	1.00	1.00	0.95	1.00
Frt	1.00	0.85		1.00	0.87		1.00	1.00	0.85	1.00	1.00	0.85
Flt Protected	0.95	1.00		0.95	1.00		0.95	1.00	1.00	0.95	1.00	1.00
Satd. Flow (prot)	1438	1286		1438	1316		1438	2875	1286	1438	2875	1286
Flt Permitted	0.73	1.00		0.40	1.00		0.30	1.00	1.00	0.45	1.00	1.00
Satd. Flow (perm)	1108	1286		599	1316		450	2875	1286	686	2875	1286
Peak-hour factor, PHF	0.76	0.92	0.76	0.92	0.92	0.92	0.87	0.87	0.92	0.92	0.91	0.91
Adj. Flow (vph)	26	0	276	27	5	33	103	534	5	5	830	23
RTOR Reduction (vph)	0	250	0	0	30	0	0	0	1	0	0	8
Lane Group Flow (vph)	26	26	0	27	8	0	103	534	4	5	830	15
Turn Type	Perm	NA		Perm	NA		pm+pt	NA	Perm	Perm	NA	Perm
Protected Phases		4			8		5	2		6		6
Permitted Phases	4			8			2		2	6		6
Actuated Green, G (s)	10.1	10.1		10.1	10.1		83.1	83.1	83.1	70.8	70.8	70.8
Effective Green, g (s)	10.1	10.1		10.1	10.1		83.1	83.1	83.1	70.8	70.8	70.8
Actuated g/C Ratio	0.10	0.10		0.10	0.10		0.78	0.78	0.78	0.67	0.67	0.67
Clearance Time (s)	6.0	6.0		6.0	6.0		5.0	7.0	7.0	7.0	7.0	7.0
Vehicle Extension (s)	3.0	3.0		3.0	3.0		3.0	3.0	3.0	3.0	3.0	3.0
Lane Grp Cap (vph)	105	122		56	125		420	2249	1006	457	1916	857
v/s Ratio Prot		0.02			0.01		0.02	c0.19			c0.29	
v/s Ratio Perm	0.02			c0.05			0.18		0.00	0.01		0.01
v/c Ratio	0.25	0.22		0.48	0.07		0.25	0.24	0.00	0.01	0.43	0.02
Uniform Delay, d1	44.5	44.4		45.6	43.8		3.2	3.1	2.5	5.9	8.3	6.0
Progression Factor	1.00	1.00		1.00	1.00		1.00	1.00	1.00	1.00	1.00	1.00
Incremental Delay, d2	1.2	0.9		6.4	0.2		0.3	0.2	0.0	0.0	0.7	0.0
Delay (s)	45.8	45.3		52.0	44.0		3.5	3.3	2.5	6.0	9.0	6.0
Level of Service	D	D		D	D		A	A	A	A	A	A
Approach Delay (s)		45.3			47.3			3.4			8.9	
Approach LOS		D			D			A			A	

Intersection Summary

HCM 2000 Control Delay	14.2	HCM 2000 Level of Service	B
HCM 2000 Volume to Capacity ratio	0.43		
Actuated Cycle Length (s)	106.2	Sum of lost time (s)	18.0
Intersection Capacity Utilization	78.1%	ICU Level of Service	D
Analysis Period (min)	15		

c Critical Lane Group

Intersection Sign configuration not allowed in HCM analysis.

HCM Signalized Intersection Capacity Analysis

9: CO 83 & Kaessner Lane/#75

09/01/2021



Movement	EBL	EBT	EBR	WBL	WBT	WBR	NBL	NBT	NBR	SBL	SBT	SBR
Lane Configurations		↕		↕	↕		↕	↕↕	↕	↕	↕↕	
Traffic Volume (vph)	5	0	10	25	1	20	5	460	0	2	795	1
Future Volume (vph)	5	0	10	25	1	20	5	460	0	2	795	1
Ideal Flow (vphpl)	1900	1900	1900	1900	1900	1900	1900	1900	1900	1900	1900	1900
Total Lost time (s)		6.0		6.0	6.0		7.0	7.0		7.0	7.0	
Lane Util. Factor		1.00		1.00	1.00		1.00	0.95		1.00	0.95	
Frt		0.91		1.00	0.86		1.00	1.00		1.00	1.00	
Flt Protected		0.98		0.95	1.00		0.95	1.00		0.95	1.00	
Satd. Flow (prot)		1502		1597	1440		1597	3195		1597	3194	
Flt Permitted		0.91		1.00	1.00		0.33	1.00		0.47	1.00	
Satd. Flow (perm)		1381		1681	1440		551	3195		788	3194	
Peak-hour factor, PHF	0.92	0.92	0.92	0.92	0.92	0.92	0.92	0.92	0.92	0.92	0.92	0.92
Adj. Flow (vph)	5	0	11	27	1	22	5	500	0	2	864	1
RTOR Reduction (vph)	0	15	0	0	21	0	0	0	0	0	0	0
Lane Group Flow (vph)	0	1	0	27	2	0	5	500	0	2	865	0
Turn Type	Perm	NA		Perm	NA		Perm	NA	Perm	Perm	NA	
Protected Phases		4			8			2			6	
Permitted Phases	4			8			2		2	6		
Actuated Green, G (s)		2.9		2.9	2.9		31.5	31.5		31.5	31.5	
Effective Green, g (s)		2.9		2.9	2.9		31.5	31.5		31.5	31.5	
Actuated g/C Ratio		0.06		0.06	0.06		0.66	0.66		0.66	0.66	
Clearance Time (s)		6.0		6.0	6.0		7.0	7.0		7.0	7.0	
Vehicle Extension (s)		3.0		3.0	3.0		3.0	3.0		3.0	3.0	
Lane Grp Cap (vph)		84		102	88		366	2123		523	2122	
v/s Ratio Prot					0.00			0.16			c0.27	
v/s Ratio Perm		0.00		c0.02			0.01			0.00		
v/c Ratio		0.01		0.26	0.03		0.01	0.24		0.00	0.41	
Uniform Delay, d1		20.9		21.2	20.9		2.7	3.2		2.7	3.7	
Progression Factor		1.00		1.00	1.00		1.00	1.00		1.00	1.00	
Incremental Delay, d2		0.1		1.4	0.1		0.0	0.1		0.0	0.1	
Delay (s)		21.0		22.6	21.0		2.7	3.2		2.7	3.8	
Level of Service		C		C	C		A	A		A	A	
Approach Delay (s)		21.0			21.9			3.2			3.8	
Approach LOS		C			C			A			A	

Intersection Summary

HCM 2000 Control Delay	4.4	HCM 2000 Level of Service	A
HCM 2000 Volume to Capacity ratio	0.40		
Actuated Cycle Length (s)	47.4	Sum of lost time (s)	13.0
Intersection Capacity Utilization	38.3%	ICU Level of Service	A
Analysis Period (min)	15		

c Critical Lane Group

HCM Signalized Intersection Capacity Analysis

10: CO 83 & Stagecoach Rd

09/01/2021

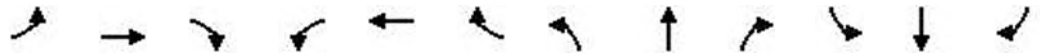

Movement	EBL	EBT	EBR	WBL	WBT	WBR	NBL	NBT	NBR	SBL	SBT	SBR
Lane Configurations		↔			↕	↗	↖	↕	↗	↖	↕	↗
Traffic Volume (vph)	0	1	10	90	5	55	1	395	55	25	750	0
Future Volume (vph)	0	1	10	90	5	55	1	395	55	25	750	0
Ideal Flow (vphpl)	1900	1900	1900	1900	1900	1900	1900	1900	1900	1900	1900	1900
Total Lost time (s)		6.0			6.0	6.0	7.0	7.0	7.0	5.0	7.0	
Lane Util. Factor		1.00			1.00	1.00	1.00	0.95	1.00	1.00	0.95	
Frt		0.88			1.00	0.85	1.00	1.00	0.85	1.00	1.00	
Flt Protected		1.00			0.95	1.00	0.95	1.00	1.00	0.95	1.00	
Satd. Flow (prot)		1478			1605	1429	1597	3195	1429	1597	3195	
Flt Permitted		1.00			0.72	1.00	0.34	1.00	1.00	0.45	1.00	
Satd. Flow (perm)		1478			1217	1429	574	3195	1429	755	3195	
Peak-hour factor, PHF	0.58	0.58	0.58	0.72	0.72	0.72	0.85	0.85	0.85	0.91	0.91	0.91
Adj. Flow (vph)	0	2	17	125	7	76	1	465	65	27	824	0
RTOR Reduction (vph)	0	15	0	0	0	65	0	0	24	0	0	0
Lane Group Flow (vph)	0	4	0	0	132	11	1	465	41	27	824	0
Turn Type		NA		Perm	NA	Perm	Perm	NA	Perm	pm+pt	NA	
Protected Phases		4			8			2		1	6	
Permitted Phases	4			8		8	2		2	6		
Actuated Green, G (s)		14.4			14.4	14.4	62.4	62.4	62.4	71.1	71.1	
Effective Green, g (s)		14.4			14.4	14.4	62.4	62.4	62.4	71.1	71.1	
Actuated g/C Ratio		0.15			0.15	0.15	0.63	0.63	0.63	0.72	0.72	
Clearance Time (s)		6.0			6.0	6.0	7.0	7.0	7.0	5.0	7.0	
Vehicle Extension (s)		3.0			3.0	3.0	3.0	3.0	3.0	3.0	3.0	
Lane Grp Cap (vph)		216			177	208	363	2024	905	576	2306	
v/s Ratio Prot		0.00						0.15		0.00	c0.26	
v/s Ratio Perm					c0.11	0.01	0.00		0.03	0.03		
v/c Ratio		0.02			0.75	0.05	0.00	0.23	0.05	0.05	0.36	
Uniform Delay, d1		36.0			40.3	36.2	6.6	7.7	6.8	4.0	5.1	
Progression Factor		1.00			1.00	1.00	1.00	1.00	1.00	1.00	1.00	
Incremental Delay, d2		0.0			15.6	0.1	0.0	0.3	0.1	0.0	0.4	
Delay (s)		36.1			55.9	36.3	6.6	8.0	6.9	4.0	5.6	
Level of Service		D			E	D	A	A	A	A	A	
Approach Delay (s)		36.1			48.8			7.9			5.5	
Approach LOS		D			D			A			A	

Intersection Summary

HCM 2000 Control Delay	12.2	HCM 2000 Level of Service	B
HCM 2000 Volume to Capacity ratio	0.45		
Actuated Cycle Length (s)	98.5	Sum of lost time (s)	18.0
Intersection Capacity Utilization	45.0%	ICU Level of Service	A
Analysis Period (min)	15		

c Critical Lane Group

HCM Unsignalized Intersection Capacity Analysis

11: CO 83 & #79

09/01/2021



Movement	EBL	EBR	NBL	NBT	SBT	SBR
Lane Configurations						
Traffic Volume (veh/h)	0	10	5	420	770	5
Future Volume (Veh/h)	0	10	5	420	770	5
Sign Control	Stop			Free	Free	
Grade	0%			0%	0%	
Peak Hour Factor	0.92	0.92	0.92	0.92	0.92	0.92
Hourly flow rate (vph)	0	11	5	457	837	5
Pedestrians						
Lane Width (ft)						
Walking Speed (ft/s)						
Percent Blockage						
Right turn flare (veh)						
Median type				None	None	
Median storage (veh)						
Upstream signal (ft)						
pX, platoon unblocked						
vC, conflicting volume	1078	421	842			
vC1, stage 1 conf vol						
vC2, stage 2 conf vol						
vCu, unblocked vol	1078	421	842			
tC, single (s)	7.1	7.2	4.4			
tC, 2 stage (s)						
tF (s)	3.6	3.4	2.3			
p0 queue free %	100	98	99			
cM capacity (veh/h)	195	552	723			
Direction, Lane #	EB 1	NB 1	NB 2	NB 3	SB 1	SB 2
Volume Total	11	5	228	228	558	284
Volume Left	0	5	0	0	0	0
Volume Right	11	0	0	0	0	5
cSH	552	723	1700	1700	1700	1700
Volume to Capacity	0.02	0.01	0.13	0.13	0.33	0.17
Queue Length 95th (ft)	2	1	0	0	0	0
Control Delay (s)	11.7	10.0	0.0	0.0	0.0	0.0
Lane LOS	B	B				
Approach Delay (s)	11.7	0.1	0.0			
Approach LOS	B					
Intersection Summary						
Average Delay	0.1					
Intersection Capacity Utilization	31.4%			ICU Level of Service	A	
Analysis Period (min)	15					

HCM Signalized Intersection Capacity Analysis

12: CO 83 & High Forest Rd

09/01/2021

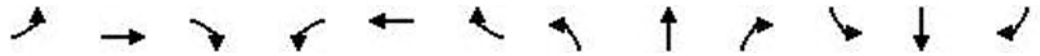

Movement	EBL	EBT	EBR	WBL	WBT	WBR	NBL	NBT	NBR	SBL	SBT	SBR
Lane Configurations		↕		↕	↕		↕	↕↕	↕	↕	↕↕	
Traffic Volume (vph)	5	1	20	65	1	15	11	370	35	10	690	10
Future Volume (vph)	5	1	20	65	1	15	11	370	35	10	690	10
Ideal Flow (vphpl)	1900	1900	1900	1900	1900	1900	1900	1900	1900	1900	1900	1900
Total Lost time (s)		6.0		6.0	6.0		5.0	7.0	7.0	5.0	7.0	
Lane Util. Factor		1.00		1.00	1.00		1.00	0.95	1.00	1.00	0.95	
Frt		0.89		1.00	0.86		1.00	1.00	0.85	1.00	1.00	
Flt Protected		0.99		0.95	1.00		0.95	1.00	1.00	0.95	1.00	
Satd. Flow (prot)		1490		1597	1443		1597	3195	1429	1597	3188	
Flt Permitted		0.94		0.74	1.00		0.35	1.00	1.00	0.50	1.00	
Satd. Flow (perm)		1411		1243	1443		582	3195	1429	839	3188	
Peak-hour factor, PHF	0.92	0.92	0.92	0.88	0.92	0.88	0.92	0.85	0.85	0.89	0.89	0.92
Adj. Flow (vph)	5	1	22	74	1	17	12	435	41	11	775	11
RTOR Reduction (vph)	0	20	0	0	15	0	0	0	15	0	1	0
Lane Group Flow (vph)	0	8	0	74	3	0	12	435	26	11	785	0
Turn Type	Perm	NA		Perm	NA		pm+pt	NA	Perm	pm+pt	NA	
Protected Phases		4			8		5	2		1	6	
Permitted Phases	4			8			2		2	6		
Actuated Green, G (s)		8.3		8.3	8.3		49.5	48.5	48.5	49.5	48.5	
Effective Green, g (s)		8.3		8.3	8.3		49.5	48.5	48.5	49.5	48.5	
Actuated g/C Ratio		0.11		0.11	0.11		0.65	0.64	0.64	0.65	0.64	
Clearance Time (s)		6.0		6.0	6.0		5.0	7.0	7.0	5.0	7.0	
Vehicle Extension (s)		3.0		3.0	3.0		3.0	3.0	3.0	3.0	3.0	
Lane Grp Cap (vph)		154		136	158		393	2044	914	557	2039	
v/s Ratio Prot					0.00		c0.00	0.14		0.00	c0.25	
v/s Ratio Perm		0.01		c0.06			0.02		0.02	0.01		
v/c Ratio		0.05		0.54	0.02		0.03	0.21	0.03	0.02	0.39	
Uniform Delay, d1		30.2		32.0	30.1		4.6	5.7	5.0	4.6	6.5	
Progression Factor		1.00		1.00	1.00		1.00	1.00	1.00	1.00	1.00	
Incremental Delay, d2		0.1		4.4	0.0		0.0	0.2	0.1	0.0	0.6	
Delay (s)		30.4		36.4	30.2		4.6	5.9	5.1	4.6	7.1	
Level of Service		C		D	C		A	A	A	A	A	
Approach Delay (s)		30.4			35.1			5.8			7.0	
Approach LOS		C			D			A			A	

Intersection Summary

HCM 2000 Control Delay	8.9	HCM 2000 Level of Service	A
HCM 2000 Volume to Capacity ratio	0.40		
Actuated Cycle Length (s)	75.8	Sum of lost time (s)	18.0
Intersection Capacity Utilization	44.2%	ICU Level of Service	A
Analysis Period (min)	15		

c Critical Lane Group

HCM Signalized Intersection Capacity Analysis

13: CO 83 & Hogden Rd

09/01/2021

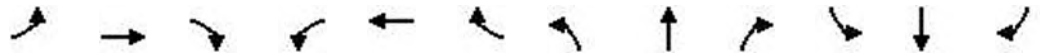

Movement	EBL	EBT	EBR	WBL	WBT	WBR	NBL	NBT	NBR	SBL	SBT	SBR
Lane Configurations												
Traffic Volume (vph)	45	105	65	315	185	325	70	225	90	110	360	40
Future Volume (vph)	45	105	65	315	185	325	70	225	90	110	360	40
Ideal Flow (vphpl)	1900	1900	1900	1900	1900	1900	1900	1900	1900	1900	1900	1900
Total Lost time (s)	6.0	6.0	6.0	6.0	6.0	6.0	6.0	7.0	7.0	6.0	7.0	
Lane Util. Factor	1.00	1.00	1.00	1.00	1.00	1.00	1.00	1.00	1.00	1.00	1.00	
Frt	1.00	1.00	0.85	1.00	1.00	0.85	1.00	1.00	0.85	1.00	0.98	
Flt Protected	0.95	1.00	1.00	0.95	1.00	1.00	0.95	1.00	1.00	0.95	1.00	
Satd. Flow (prot)	1597	1681	1429	1597	1681	1429	1597	1681	1429	1597	1656	
Flt Permitted	0.95	1.00	1.00	0.95	1.00	1.00	0.33	1.00	1.00	0.50	1.00	
Satd. Flow (perm)	1597	1681	1429	1597	1681	1429	557	1681	1429	849	1656	
Peak-hour factor, PHF	0.71	0.71	0.71	0.92	0.92	0.92	0.89	0.89	0.89	0.94	0.94	0.94
Adj. Flow (vph)	63	148	92	342	201	353	79	253	101	117	383	43
RTOR Reduction (vph)	0	0	81	0	0	263	0	0	66	0	3	0
Lane Group Flow (vph)	63	148	11	342	201	90	79	253	35	117	423	0
Turn Type	Split	NA	Perm	Split	NA	Perm	pm+pt	NA	Perm	pm+pt	NA	
Protected Phases	4	4		8	8		5	2		1	6	
Permitted Phases			4			8	2		2	6		
Actuated Green, G (s)	14.2	14.2	14.2	29.2	29.2	29.2	44.4	39.8	39.8	47.4	41.3	
Effective Green, g (s)	14.2	14.2	14.2	29.2	29.2	29.2	44.4	39.8	39.8	47.4	41.3	
Actuated g/C Ratio	0.12	0.12	0.12	0.26	0.26	0.26	0.39	0.35	0.35	0.41	0.36	
Clearance Time (s)	6.0	6.0	6.0	6.0	6.0	6.0	6.0	7.0	7.0	6.0	7.0	
Vehicle Extension (s)	3.0	3.0	3.0	3.0	3.0	3.0	3.0	3.0	3.0	3.0	3.0	
Lane Grp Cap (vph)	198	208	177	407	429	365	258	585	497	391	598	
v/s Ratio Prot	0.04	c0.09		c0.21	0.12		0.01	0.15		c0.02	c0.26	
v/s Ratio Perm			0.01			0.06	0.11		0.02	0.11		
v/c Ratio	0.32	0.71	0.06	0.84	0.47	0.25	0.31	0.43	0.07	0.30	0.71	
Uniform Delay, d1	45.6	48.1	44.2	40.3	36.0	33.8	23.4	28.6	24.9	21.3	31.3	
Progression Factor	1.00	1.00	1.00	1.00	1.00	1.00	1.00	1.00	1.00	1.00	1.00	
Incremental Delay, d2	0.9	10.9	0.2	14.4	0.8	0.4	0.7	0.5	0.1	0.4	3.8	
Delay (s)	46.6	59.0	44.3	54.8	36.8	34.2	24.1	29.1	25.0	21.8	35.1	
Level of Service	D	E	D	D	D	C	C	C	C	C	D	
Approach Delay (s)		52.0			42.6			27.2			32.2	
Approach LOS		D			D			C			C	

Intersection Summary

HCM 2000 Control Delay	38.3	HCM 2000 Level of Service	D
HCM 2000 Volume to Capacity ratio	0.73		
Actuated Cycle Length (s)	114.3	Sum of lost time (s)	25.0
Intersection Capacity Utilization	80.2%	ICU Level of Service	D
Analysis Period (min)	15		

c Critical Lane Group

HCM Signalized Intersection Capacity Analysis

14: CO 83 & #79

09/01/2021



Movement	EBL	EBT	EBR	WBL	WBT	WBR	NBL	NBT	NBR	SBL	SBT	SBR
Lane Configurations		↕		↖	↗			↗		↖	↗	
Traffic Volume (vph)	5	0	5	20	0	15	0	590	5	15	535	0
Future Volume (vph)	5	0	5	20	0	15	0	590	5	15	535	0
Ideal Flow (vphpl)	1900	1900	1900	1900	1900	1900	1900	1900	1900	1900	1900	1900
Total Lost time (s)		6.0		6.0	6.0			7.0		7.0	7.0	
Lane Util. Factor		1.00		1.00	1.00			1.00		1.00	1.00	
Frt		0.93		1.00	0.85			1.00		1.00	1.00	
Flt Protected		0.98		0.95	1.00			1.00		0.95	1.00	
Satd. Flow (prot)		1530		1597	1429			1680		1597	1681	
Flt Permitted		0.83		0.85	1.00			1.00		0.40	1.00	
Satd. Flow (perm)		1307		1431	1429			1680		670	1681	
Peak-hour factor, PHF	0.92	0.92	0.92	0.92	0.92	0.92	0.92	0.92	0.92	0.92	0.92	0.92
Adj. Flow (vph)	5	0	5	22	0	16	0	641	5	16	582	0
RTOR Reduction (vph)	0	9	0	0	15	0	0	0	0	0	0	0
Lane Group Flow (vph)	0	1	0	22	1	0	0	646	0	16	582	0
Turn Type	Perm	NA		Perm	NA			NA		Perm	NA	
Protected Phases		4			8			2			6	
Permitted Phases	4			8						6		
Actuated Green, G (s)		4.7		4.7	4.7			58.9		58.9	58.9	
Effective Green, g (s)		4.7		4.7	4.7			58.9		58.9	58.9	
Actuated g/C Ratio		0.06		0.06	0.06			0.77		0.77	0.77	
Clearance Time (s)		6.0		6.0	6.0			7.0		7.0	7.0	
Vehicle Extension (s)		3.0		3.0	3.0			3.0		3.0	3.0	
Lane Grp Cap (vph)		80		87	87			1291		515	1292	
v/s Ratio Prot					0.00			c0.38			0.35	
v/s Ratio Perm		0.00		c0.02						0.02		
v/c Ratio		0.01		0.25	0.01			0.50		0.03	0.45	
Uniform Delay, d1		33.8		34.3	33.8			3.3		2.1	3.1	
Progression Factor		1.00		1.00	1.00			1.00		1.00	1.00	
Incremental Delay, d2		0.0		1.5	0.1			1.4		0.1	1.1	
Delay (s)		33.8		35.8	33.8			4.7		2.2	4.3	
Level of Service		C		D	C			A		A	A	
Approach Delay (s)		33.8			35.0			4.7			4.2	
Approach LOS		C			C			A			A	

Intersection Summary

HCM 2000 Control Delay	5.6	HCM 2000 Level of Service	A
HCM 2000 Volume to Capacity ratio	0.48		
Actuated Cycle Length (s)	76.6	Sum of lost time (s)	13.0
Intersection Capacity Utilization	47.3%	ICU Level of Service	A
Analysis Period (min)	15		

c Critical Lane Group

HCM Signalized Intersection Capacity Analysis

15: CO 83 & Walden Way

09/01/2021

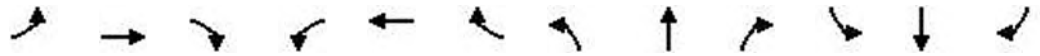

Movement	EBL	EBT	EBR	WBL	WBT	WBR	NBL	NBT	NBR	SBL	SBT	SBR
Lane Configurations		↔		↔	↔		↔	↔		↔	↔	
Traffic Volume (vph)	15	1	10	10	1	70	5	673	5	20	535	5
Future Volume (vph)	15	1	10	10	1	70	5	673	5	20	535	5
Ideal Flow (vphpl)	1900	1900	1900	1900	1900	1900	1900	1900	1900	1900	1900	1900
Total Lost time (s)		6.0		6.0	6.0		7.0	7.0		5.0	7.0	
Lane Util. Factor		1.00		1.00	1.00		1.00	1.00		1.00	1.00	
Frt		0.95		1.00	0.85		1.00	1.00		1.00	1.00	
Flt Protected		0.97		0.95	1.00		0.95	1.00		0.95	1.00	
Satd. Flow (prot)		1548		1597	1430		1597	1680		1597	1679	
Flt Permitted		0.42		0.74	1.00		0.44	1.00		0.27	1.00	
Satd. Flow (perm)		673		1243	1430		737	1680		461	1679	
Peak-hour factor, PHF	0.92	0.92	0.92	0.35	0.92	0.35	0.92	0.93	0.93	0.90	0.90	0.92
Adj. Flow (vph)	16	1	11	29	1	200	5	724	5	22	594	5
RTOR Reduction (vph)	0	10	0	0	180	0	0	0	0	0	0	0
Lane Group Flow (vph)	0	18	0	29	21	0	5	729	0	22	599	0
Turn Type	Perm	NA		Perm	NA		Perm	NA		pm+pt	NA	
Protected Phases		4			8			2		1	6	
Permitted Phases	4			8			2			6		
Actuated Green, G (s)		8.0		8.0	8.0		53.5	53.5		60.7	60.7	
Effective Green, g (s)		8.0		8.0	8.0		53.5	53.5		60.7	60.7	
Actuated g/C Ratio		0.10		0.10	0.10		0.65	0.65		0.74	0.74	
Clearance Time (s)		6.0		6.0	6.0		7.0	7.0		5.0	7.0	
Vehicle Extension (s)		3.0		3.0	3.0		3.0	3.0		3.0	3.0	
Lane Grp Cap (vph)		65		121	140		482	1100		373	1247	
v/s Ratio Prot					0.01			c0.43		0.00	c0.36	
v/s Ratio Perm		c0.03		0.02			0.01			0.04		
v/c Ratio		0.28		0.24	0.15		0.01	0.66		0.06	0.48	
Uniform Delay, d1		34.2		34.0	33.7		4.9	8.6		4.6	4.2	
Progression Factor		1.00		1.00	1.00		1.00	1.00		1.00	1.00	
Incremental Delay, d2		2.3		1.0	0.5		0.0	3.1		0.1	1.3	
Delay (s)		36.5		35.1	34.2		4.9	11.7		4.7	5.5	
Level of Service		D		D	C		A	B		A	A	
Approach Delay (s)		36.5			34.3			11.7			5.5	
Approach LOS		D			C			B			A	

Intersection Summary

HCM 2000 Control Delay	13.0	HCM 2000 Level of Service	B
HCM 2000 Volume to Capacity ratio	0.63		
Actuated Cycle Length (s)	81.7	Sum of lost time (s)	18.0
Intersection Capacity Utilization	54.7%	ICU Level of Service	A
Analysis Period (min)	15		

c Critical Lane Group

HCM Unsignalized Intersection Capacity Analysis
 16: CO 83 & Pinehurst RI only

09/01/2021



Movement	WBL	WBR	NBT	NBR	SBL	SBT
Lane Configurations			↑	↗		↑↑
Traffic Volume (veh/h)	0	0	600	235	0	765
Future Volume (Veh/h)	0	0	600	235	0	765
Sign Control	Stop		Free		Free	
Grade	0%		0%		0%	
Peak Hour Factor	0.92	0.92	0.92	0.92	0.92	0.92
Hourly flow rate (vph)	0	0	652	255	0	832
Pedestrians						
Lane Width (ft)						
Walking Speed (ft/s)						
Percent Blockage						
Right turn flare (veh)						
Median type	None			None		
Median storage (veh)						
Upstream signal (ft)						
pX, platoon unblocked						
vC, conflicting volume	1068	652			907	
vC1, stage 1 conf vol						
vC2, stage 2 conf vol						
vCu, unblocked vol	1068	652			907	
tC, single (s)	7.1	7.2			4.4	
tC, 2 stage (s)						
tF (s)	3.6	3.4			2.3	
p0 queue free %	100	100			100	
cM capacity (veh/h)	199	385			681	
Direction, Lane #	NB 1	NB 2	SB 1	SB 2		
Volume Total	652	255	416	416		
Volume Left	0	0	0	0		
Volume Right	0	255	0	0		
cSH	1700	1700	1700	1700		
Volume to Capacity	0.38	0.15	0.24	0.24		
Queue Length 95th (ft)	0	0	0	0		
Control Delay (s)	0.0	0.0	0.0	0.0		
Lane LOS						
Approach Delay (s)	0.0		0.0			
Approach LOS						
Intersection Summary						
Average Delay			0.0			
Intersection Capacity Utilization			34.9%		ICU Level of Service	A
Analysis Period (min)			15			

HCM Signalized Intersection Capacity Analysis

17: CO 83 & CR 105/Walker Rd

09/01/2021

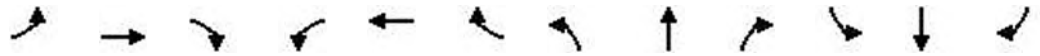

Movement	EBL	EBT	EBR	WBL	WBT	WBR	NBL	NBT	NBR	SBL	SBT	SBR
Lane Configurations												
Traffic Volume (vph)	70	550	180	290	475	135	300	345	125	170	295	100
Future Volume (vph)	70	550	180	290	475	135	300	345	125	170	295	100
Ideal Flow (vphpl)	1900	1900	1900	1900	1900	1900	1900	1900	1900	1900	1900	1900
Total Lost time (s)	4.5	6.0	4.0	4.5	6.0	6.0	5.0	7.0	7.0	5.0	7.0	7.0
Lane Util. Factor	1.00	0.95	1.00	1.00	0.95	1.00	1.00	1.00	1.00	1.00	1.00	1.00
Frt	1.00	1.00	0.85	1.00	1.00	0.85	1.00	1.00	0.85	1.00	1.00	0.85
Flt Protected	0.95	1.00	1.00	0.95	1.00	1.00	0.95	1.00	1.00	0.95	1.00	1.00
Satd. Flow (prot)	1597	3195	1429	1597	3195	1429	1597	1681	1429	1597	1681	1429
Flt Permitted	0.37	1.00	1.00	0.12	1.00	1.00	0.28	1.00	1.00	0.32	1.00	1.00
Satd. Flow (perm)	629	3195	1429	201	3195	1429	471	1681	1429	531	1681	1429
Peak-hour factor, PHF	0.64	0.64	0.64	0.65	0.65	0.65	0.98	0.98	0.98	0.83	0.83	0.83
Adj. Flow (vph)	109	859	281	446	731	208	306	352	128	205	355	120
RTOR Reduction (vph)	0	0	0	0	0	128	0	0	94	0	0	89
Lane Group Flow (vph)	109	859	281	446	731	80	306	352	34	205	355	31
Turn Type	pm+pt	NA	Free	pm+pt	NA	Perm	pm+pt	NA	Perm	pm+pt	NA	Perm
Protected Phases	7	4		3	8		5	2		1	6	
Permitted Phases	4		Free	8		8	2		2	6		6
Actuated Green, G (s)	37.8	29.0	118.9	59.0	45.7	45.7	42.9	31.9	31.9	40.9	30.9	30.9
Effective Green, g (s)	37.8	29.0	118.9	59.0	45.7	45.7	42.9	31.9	31.9	40.9	30.9	30.9
Actuated g/C Ratio	0.32	0.24	1.00	0.50	0.38	0.38	0.36	0.27	0.27	0.34	0.26	0.26
Clearance Time (s)	4.5	6.0		4.5	6.0	6.0	5.0	7.0	7.0	5.0	7.0	7.0
Vehicle Extension (s)	3.0	3.0		3.0	3.0	3.0	3.0	3.0	3.0	3.0	3.0	3.0
Lane Grp Cap (vph)	271	779	1429	399	1228	549	274	451	383	272	436	371
v/s Ratio Prot	0.03	0.27		c0.24	0.23		c0.10	0.21		0.06	0.21	
v/s Ratio Perm	0.10		c0.20	c0.32		0.06	c0.30		0.02	0.20		0.02
v/c Ratio	0.40	1.10	0.20	1.12	0.60	0.15	1.12	0.78	0.09	0.75	0.81	0.08
Uniform Delay, d1	29.7	45.0	0.0	36.1	29.2	23.9	35.5	40.3	32.6	31.8	41.3	33.3
Progression Factor	1.00	1.00	1.00	1.00	1.00	1.00	1.00	1.00	1.00	1.00	1.00	1.00
Incremental Delay, d2	1.0	64.1	0.3	81.0	0.8	0.1	89.5	8.5	0.1	11.2	11.1	0.1
Delay (s)	30.7	109.1	0.3	117.1	30.0	24.0	125.0	48.8	32.7	43.0	52.4	33.4
Level of Service	C	F	A	F	C	C	F	D	C	D	D	C
Approach Delay (s)		77.7			57.1			75.8			46.2	
Approach LOS		E			E			E			D	

Intersection Summary

HCM 2000 Control Delay	65.2	HCM 2000 Level of Service	E
HCM 2000 Volume to Capacity ratio	1.16		
Actuated Cycle Length (s)	118.9	Sum of lost time (s)	22.5
Intersection Capacity Utilization	91.6%	ICU Level of Service	F
Analysis Period (min)	15		

c Critical Lane Group

HCM Signalized Intersection Capacity Analysis

18: CO 83 & #82/#81

09/01/2021

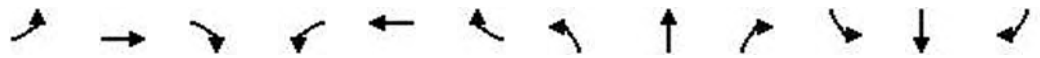

Movement	EBL	EBT	EBR	WBL	WBT	WBR	NBL	NBT	NBR	SBL	SBT	SBR
Lane Configurations		↕			↕		↗	↖		↗	↖	
Traffic Volume (vph)	30	5	40	40	5	30	10	345	5	5	295	5
Future Volume (vph)	30	5	40	40	5	30	10	345	5	5	295	5
Ideal Flow (vphpl)	1900	1900	1900	1900	1900	1900	1900	1900	1900	1900	1900	1900
Total Lost time (s)		6.0			6.0		7.0	7.0		7.0	7.0	
Lane Util. Factor		1.00			1.00		1.00	1.00		1.00	1.00	
Frt		0.93			0.94		1.00	1.00		1.00	1.00	
Flt Protected		0.98			0.97		0.95	1.00		0.95	1.00	
Satd. Flow (prot)		1530			1548		1597	1678		1597	1678	
Flt Permitted		0.87			0.84		0.56	1.00		0.54	1.00	
Satd. Flow (perm)		1363			1341		947	1678		902	1678	
Peak-hour factor, PHF	0.92	0.92	0.92	0.92	0.92	0.92	0.92	0.92	0.92	0.92	0.92	0.92
Adj. Flow (vph)	33	5	43	43	5	33	11	375	5	5	321	5
RTOR Reduction (vph)	0	39	0	0	27	0	0	0	0	0	0	0
Lane Group Flow (vph)	0	42	0	0	54	0	11	380	0	5	326	0
Turn Type	Perm	NA		Perm	NA		Perm	NA		Perm	NA	
Protected Phases		4			8			2			6	
Permitted Phases	4			8			2			6		
Actuated Green, G (s)		8.2			8.2		72.1	72.1		72.1	72.1	
Effective Green, g (s)		8.2			8.2		72.1	72.1		72.1	72.1	
Actuated g/C Ratio		0.09			0.09		0.77	0.77		0.77	0.77	
Clearance Time (s)		6.0			6.0		7.0	7.0		7.0	7.0	
Vehicle Extension (s)		3.0			3.0		3.0	3.0		3.0	3.0	
Lane Grp Cap (vph)		119			117		731	1296		697	1296	
v/s Ratio Prot								c0.23				0.19
v/s Ratio Perm		0.03			c0.04		0.01			0.01		
v/c Ratio		0.35			0.46		0.02	0.29		0.01	0.25	
Uniform Delay, d1		40.0			40.4		2.4	3.1		2.4	3.0	
Progression Factor		1.00			1.00		1.00	1.00		1.00	1.00	
Incremental Delay, d2		1.8			2.8		0.0	0.6		0.0	0.5	
Delay (s)		41.8			43.3		2.5	3.7		2.4	3.5	
Level of Service		D			D		A	A		A	A	
Approach Delay (s)		41.8			43.3			3.7			3.4	
Approach LOS		D			D			A			A	

Intersection Summary

HCM 2000 Control Delay	10.7	HCM 2000 Level of Service	B
HCM 2000 Volume to Capacity ratio	0.31		
Actuated Cycle Length (s)	93.3	Sum of lost time (s)	13.0
Intersection Capacity Utilization	36.3%	ICU Level of Service	A
Analysis Period (min)	15		

c Critical Lane Group

HCM Signalized Intersection Capacity Analysis

19: CO 83 & #69

09/01/2021



Movement	EBL	EBR	NBL	NBT	SBT	SBR
Lane Configurations						
Traffic Volume (vph)	25	15	5	350	300	5
Future Volume (vph)	25	15	5	350	300	5
Ideal Flow (vphpl)	1900	1900	1900	1900	1900	1900
Total Lost time (s)	5.0	5.0	5.0	5.0	5.0	5.0
Lane Util. Factor	1.00	1.00	1.00	1.00	1.00	1.00
Frt	1.00	0.85	1.00	1.00	1.00	0.85
Flt Protected	0.95	1.00	0.95	1.00	1.00	1.00
Satd. Flow (prot)	1597	1429	1597	1681	1681	1429
Flt Permitted	0.95	1.00	0.56	1.00	1.00	1.00
Satd. Flow (perm)	1597	1429	947	1681	1681	1429
Peak-hour factor, PHF	0.92	0.92	0.92	0.92	0.92	0.92
Adj. Flow (vph)	27	16	5	380	326	5
RTOR Reduction (vph)	0	15	0	0	0	1
Lane Group Flow (vph)	27	1	5	380	326	4
Turn Type	Prot	Perm	Perm	NA	NA	Perm
Protected Phases	4			2	6	
Permitted Phases		4	2			6
Actuated Green, G (s)	4.6	4.6	60.9	60.9	60.9	60.9
Effective Green, g (s)	4.6	4.6	60.9	60.9	60.9	60.9
Actuated g/C Ratio	0.06	0.06	0.81	0.81	0.81	0.81
Clearance Time (s)	5.0	5.0	5.0	5.0	5.0	5.0
Vehicle Extension (s)	3.0	3.0	3.0	3.0	3.0	3.0
Lane Grp Cap (vph)	97	87	763	1355	1355	1152
v/s Ratio Prot	c0.02			c0.23	0.19	
v/s Ratio Perm		0.00	0.01			0.00
v/c Ratio	0.28	0.01	0.01	0.28	0.24	0.00
Uniform Delay, d1	33.9	33.3	1.4	1.8	1.8	1.4
Progression Factor	1.00	1.00	1.00	1.00	1.00	1.00
Incremental Delay, d2	1.6	0.1	0.0	0.5	0.4	0.0
Delay (s)	35.4	33.4	1.4	2.3	2.2	1.4
Level of Service	D	C	A	A	A	A
Approach Delay (s)	34.7			2.3	2.2	
Approach LOS	C			A	A	

Intersection Summary

HCM 2000 Control Delay	4.1	HCM 2000 Level of Service	A
HCM 2000 Volume to Capacity ratio	0.28		
Actuated Cycle Length (s)	75.5	Sum of lost time (s)	10.0
Intersection Capacity Utilization	30.8%	ICU Level of Service	A
Analysis Period (min)	15		

c Critical Lane Group

HCM Signalized Intersection Capacity Analysis
 20: CO 83 & E Palmer Divide Ave

09/01/2021

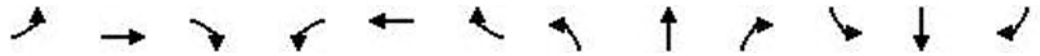

Movement	EBL	EBT	EBR	WBL	WBT	WBR	NBL	NBT	NBR	SBL	SBT	SBR
Lane Configurations												
Traffic Volume (vph)	20	25	105	160	70	20	150	305	30	5	170	25
Future Volume (vph)	20	25	105	160	70	20	150	305	30	5	170	25
Ideal Flow (vphpl)	1900	1900	1900	1900	1900	1900	1900	1900	1900	1900	1900	1900
Total Lost time (s)	4.5	7.0	7.0	4.5	7.0	7.0	4.5	8.0		4.5	8.0	
Lane Util. Factor	1.00	1.00	1.00	1.00	1.00	1.00	1.00	1.00		1.00	1.00	
Frt	1.00	1.00	0.85	1.00	1.00	0.85	1.00	0.99		1.00	0.98	
Flt Protected	0.95	1.00	1.00	0.95	1.00	1.00	0.95	1.00		0.95	1.00	
Satd. Flow (prot)	1597	1681	1429	1597	1681	1429	1597	1659		1597	1649	
Flt Permitted	0.71	1.00	1.00	0.54	1.00	1.00	0.49	1.00		0.55	1.00	
Satd. Flow (perm)	1186	1681	1429	903	1681	1429	831	1659		918	1649	
Peak-hour factor, PHF	0.69	0.69	0.69	0.89	0.89	0.89	0.93	0.93	0.93	0.84	0.84	0.84
Adj. Flow (vph)	29	36	152	180	79	22	161	328	32	6	202	30
RTOR Reduction (vph)	0	0	129	0	0	16	0	3	0	0	5	0
Lane Group Flow (vph)	29	36	23	180	79	6	161	357	0	6	227	0
Turn Type	pm+pt	NA	Perm	pm+pt	NA	Perm	pm+pt	NA		pm+pt	NA	
Protected Phases	7	4		3	8		5	2		1	6	
Permitted Phases	4		4	8		8	2			6		
Actuated Green, G (s)	14.5	12.3	12.3	28.4	21.7	21.7	38.1	32.6		23.4	22.4	
Effective Green, g (s)	14.5	12.3	12.3	28.4	21.7	21.7	38.1	32.6		23.4	22.4	
Actuated g/C Ratio	0.18	0.15	0.15	0.35	0.27	0.27	0.47	0.40		0.29	0.27	
Clearance Time (s)	4.5	7.0	7.0	4.5	7.0	7.0	4.5	8.0		4.5	8.0	
Vehicle Extension (s)	3.0	5.0	5.0	3.0	5.0	5.0	3.0	5.0		3.0	5.0	
Lane Grp Cap (vph)	222	253	215	413	447	380	493	663		271	453	
v/s Ratio Prot	0.00	0.02		c0.06	0.05		c0.04	c0.22		0.00	0.14	
v/s Ratio Perm	0.02		0.02	c0.09		0.00	0.11			0.01		
v/c Ratio	0.13	0.14	0.11	0.44	0.18	0.02	0.33	0.54		0.02	0.50	
Uniform Delay, d1	28.0	30.0	29.9	19.6	23.0	22.0	13.1	18.7		20.8	24.8	
Progression Factor	1.00	1.00	1.00	1.00	1.00	1.00	1.00	1.00		1.00	1.00	
Incremental Delay, d2	0.3	0.5	0.5	0.7	0.4	0.0	0.4	1.5		0.0	1.8	
Delay (s)	28.3	30.6	30.3	20.4	23.4	22.1	13.4	20.2		20.8	26.7	
Level of Service	C	C	C	C	C	C	B	C		C	C	
Approach Delay (s)		30.1			21.4			18.1			26.5	
Approach LOS		C			C			B			C	

Intersection Summary

HCM 2000 Control Delay	22.5	HCM 2000 Level of Service	C
HCM 2000 Volume to Capacity ratio	0.53		
Actuated Cycle Length (s)	81.5	Sum of lost time (s)	24.0
Intersection Capacity Utilization	53.8%	ICU Level of Service	A
Analysis Period (min)	15		

c Critical Lane Group

HCM Signalized Intersection Capacity Analysis

1: CO 83 & SO 21 SB

09/01/2021



Movement	SEL	SET	SER	NWL	NWT	NWR	NEL	NET	NER	SWL	SWT	SWR
Lane Configurations	↖↗		↖					↖↗↘	↖	↖↗	↖↗↘	
Traffic Volume (vph)	600	0	450	0	0	0	0	810	715	675	635	0
Future Volume (vph)	600	0	450	0	0	0	0	810	715	675	635	0
Ideal Flow (vphpl)	1900	1900	1900	1900	1900	1900	1900	1900	1900	1900	1900	1900
Total Lost time (s)	4.5		4.5					7.5	4.0	5.0	7.5	
Lane Util. Factor	0.97		1.00					0.91	1.00	0.97	0.91	
Frt	1.00		0.85					1.00	0.85	1.00	1.00	
Flt Protected	0.95		1.00					1.00	1.00	0.95	1.00	
Satd. Flow (prot)	3099		1429					4590	1429	3099	4590	
Flt Permitted	0.95		1.00					1.00	1.00	0.22	1.00	
Satd. Flow (perm)	3099		1429					4590	1429	713	4590	
Peak-hour factor, PHF	0.92	0.92	0.92	0.92	0.92	0.92	0.92	0.91	0.91	0.90	0.90	0.92
Adj. Flow (vph)	652	0	489	0	0	0	0	890	786	750	706	0
RTOR Reduction (vph)	0	0	138	0	0	0	0	0	0	0	0	0
Lane Group Flow (vph)	652	0	351	0	0	0	0	890	786	750	706	0
Turn Type	Prot		Perm					NA	Free	pm+pt	NA	
Protected Phases	4							2		1	6	
Permitted Phases	4		4						Free	6		
Actuated Green, G (s)	35.1		35.1					44.3	120.0	72.9	72.9	
Effective Green, g (s)	35.1		35.1					44.3	120.0	72.9	72.9	
Actuated g/C Ratio	0.29		0.29					0.37	1.00	0.61	0.61	
Clearance Time (s)	4.5		4.5					7.5		5.0	7.5	
Vehicle Extension (s)	3.0		3.0					1.0		3.0	1.0	
Lane Grp Cap (vph)	906		417					1694	1429	902	2788	
v/s Ratio Prot	0.21							0.19		c0.16	0.15	
v/s Ratio Perm			c0.25						0.55	c0.34		
v/c Ratio	0.72		0.84					0.53	0.55	0.83	0.25	
Uniform Delay, d1	38.0		39.8					29.6	0.0	16.7	10.9	
Progression Factor	1.00		1.00					1.00	1.00	1.49	1.38	
Incremental Delay, d2	2.8		14.2					1.2	1.5	5.6	0.2	
Delay (s)	40.8		54.1					30.8	1.5	30.5	15.3	
Level of Service	D		D					C	A	C	B	
Approach Delay (s)		46.5			0.0			17.1			23.1	
Approach LOS		D			A			B			C	

Intersection Summary

HCM 2000 Control Delay	27.0	HCM 2000 Level of Service	C
HCM 2000 Volume to Capacity ratio	0.86		
Actuated Cycle Length (s)	120.0	Sum of lost time (s)	17.0
Intersection Capacity Utilization	70.3%	ICU Level of Service	C
Analysis Period (min)	15		

c Critical Lane Group

HCM Signalized Intersection Capacity Analysis

2: CO 83 & CO 21 NB

09/01/2021



Movement	SEL	SET	SER	NWL	NWT	NWR	NEL	NET	NER	SWL	SWT	SWR
Lane Configurations				↔↔		↗	↔↔	↕↕↕			↕↕↕	↗
Traffic Volume (vph)	0	0	0	595	0	610	600	810	0	0	715	350
Future Volume (vph)	0	0	0	595	0	610	600	810	0	0	715	350
Ideal Flow (vphpl)	1900	1900	1900	1900	1900	1900	1900	1900	1900	1900	1900	1900
Total Lost time (s)				6.5		4.0	4.5	7.5			6.5	6.5
Lane Util. Factor				0.97		1.00	0.97	0.91			0.91	1.00
Frt				1.00		0.85	1.00	1.00			1.00	0.85
Flt Protected				0.95		1.00	0.95	1.00			1.00	1.00
Satd. Flow (prot)				3099		1429	3099	4590			4590	1429
Flt Permitted				0.95		1.00	0.95	1.00			1.00	1.00
Satd. Flow (perm)				3099		1429	3099	4590			4590	1429
Peak-hour factor, PHF	0.92	0.92	0.92	0.96	0.92	0.96	0.92	0.90	0.90	0.89	0.89	0.92
Adj. Flow (vph)	0	0	0	620	0	635	652	900	0	0	803	380
RTOR Reduction (vph)	0	0	0	0	0	0	0	0	0	0	0	240
Lane Group Flow (vph)	0	0	0	620	0	635	652	900	0	0	803	140
Turn Type				Prot		Free	Prot	NA			NA	Perm
Protected Phases				4			5	2			6	
Permitted Phases						Free						6
Actuated Green, G (s)				28.3		120.0	30.1	77.7			44.1	44.1
Effective Green, g (s)				28.3		120.0	30.1	77.7			44.1	44.1
Actuated g/C Ratio				0.24		1.00	0.25	0.65			0.37	0.37
Clearance Time (s)				6.5			4.5	7.5			6.5	6.5
Vehicle Extension (s)				2.0			3.0	1.0			1.0	1.0
Lane Grp Cap (vph)				730		1429	777	2972			1686	525
v/s Ratio Prot				c0.20			c0.21	0.20			0.17	
v/s Ratio Perm						c0.44						0.10
v/c Ratio				0.85		0.44	0.84	0.30			0.48	0.27
Uniform Delay, d1				43.8		0.0	42.7	9.3			29.1	26.6
Progression Factor				1.00		1.00	0.85	0.33			1.00	1.00
Incremental Delay, d2				8.8		1.0	6.8	0.2			1.0	1.2
Delay (s)				52.6		1.0	43.1	3.3			30.1	27.8
Level of Service				D		A	D	A			C	C
Approach Delay (s)		0.0			26.5			20.0			29.3	
Approach LOS		A			C			C			C	

Intersection Summary

HCM 2000 Control Delay	24.8	HCM 2000 Level of Service	C
HCM 2000 Volume to Capacity ratio	0.70		
Actuated Cycle Length (s)	120.0	Sum of lost time (s)	17.5
Intersection Capacity Utilization	70.3%	ICU Level of Service	C
Analysis Period (min)	15		

c Critical Lane Group

Intersection has too many lanes per leg.

HCM All-Way analysis is limited to two lanes per leg.

Channelized right turn lanes are not counted.

HCM Signalized Intersection Capacity Analysis

4: CO 83 & Shoup Road

09/01/2021



Movement	NBT	NBR	SBL	SBT	SWL	SWR
Lane Configurations	↑↑↑	↑↗	↘	↑↑↑	↘	↗
Traffic Volume (vph)	1100	435	290	930	435	290
Future Volume (vph)	1100	435	290	930	435	290
Ideal Flow (vphpl)	1900	1900	1900	1900	1900	1900
Total Lost time (s)	7.5	4.0	5.0	7.5	6.0	4.0
Lane Util. Factor	0.91	1.00	1.00	0.91	1.00	1.00
Frt	1.00	0.85	1.00	1.00	1.00	0.85
Flt Protected	1.00	1.00	0.95	1.00	0.95	1.00
Satd. Flow (prot)	4590	1429	1597	4590	1597	1429
Flt Permitted	1.00	1.00	0.12	1.00	0.95	1.00
Satd. Flow (perm)	4590	1429	195	4590	1597	1429
Peak-hour factor, PHF	0.97	0.97	0.93	0.93	0.79	0.79
Adj. Flow (vph)	1134	448	312	1000	551	367
RTOR Reduction (vph)	0	0	0	0	0	0
Lane Group Flow (vph)	1134	448	312	1000	551	367
Turn Type	NA	Free	pm+pt	NA	Prot	Free
Protected Phases	2		1	6	8	
Permitted Phases		Free	6			Free
Actuated Green, G (s)	35.1	112.0	58.1	58.1	40.4	112.0
Effective Green, g (s)	35.1	112.0	58.1	58.1	40.4	112.0
Actuated g/C Ratio	0.31	1.00	0.52	0.52	0.36	1.00
Clearance Time (s)	7.5		5.0	7.5	6.0	
Vehicle Extension (s)	1.0		1.0	1.0	3.0	
Lane Grp Cap (vph)	1438	1429	326	2381	576	1429
v/s Ratio Prot	0.25		c0.15	0.22	c0.34	
v/s Ratio Perm		0.31	c0.34			0.26
v/c Ratio	0.79	0.31	0.96	0.42	0.96	0.26
Uniform Delay, d1	35.1	0.0	30.3	16.6	34.9	0.0
Progression Factor	1.00	1.00	1.00	1.00	1.00	1.00
Incremental Delay, d2	4.5	0.6	37.8	0.5	26.7	0.4
Delay (s)	39.5	0.6	68.2	17.1	61.7	0.4
Level of Service	D	A	E	B	E	A
Approach Delay (s)	28.5			29.3	37.2	
Approach LOS	C			C	D	

Intersection Summary

HCM 2000 Control Delay	30.9	HCM 2000 Level of Service	C
HCM 2000 Volume to Capacity ratio	0.98		
Actuated Cycle Length (s)	112.0	Sum of lost time (s)	18.5
Intersection Capacity Utilization	76.8%	ICU Level of Service	D
Analysis Period (min)	15		

c Critical Lane Group

HCM Signalized Intersection Capacity Analysis

5: CO 83 & Flying Horse Club Dr/Abert Way

09/01/2021



Movement	EBL	EBT	EBR	WBL	WBT	WBR	NBL	NBT	NBR	SBL	SBT	SBR
Lane Configurations	↰	↑	↱	↰	↱		↰	↑↑↑	↱	↰	↑↑↑	↱
Traffic Volume (vph)	155	5	290	5	0	5	255	1125	10	10	990	140
Future Volume (vph)	155	5	290	5	0	5	255	1125	10	10	990	140
Ideal Flow (vphpl)	1900	1900	1900	1900	1900	1900	1900	1900	1900	1900	1900	1900
Total Lost time (s)	7.0	7.0	7.0	7.0	7.0		7.0	8.0	8.0	7.0	8.0	8.0
Lane Util. Factor	1.00	1.00	1.00	1.00	1.00		1.00	0.91	1.00	1.00	0.91	1.00
Frpb, ped/bikes	1.00	1.00	1.00	1.00	1.00		1.00	1.00	0.97	1.00	1.00	1.00
Flpb, ped/bikes	1.00	1.00	1.00	1.00	1.00		1.00	1.00	1.00	1.00	1.00	1.00
Frt	1.00	1.00	0.85	1.00	0.85		1.00	1.00	0.85	1.00	1.00	0.85
Flt Protected	0.95	1.00	1.00	0.95	1.00		0.95	1.00	1.00	0.95	1.00	1.00
Satd. Flow (prot)	1597	1681	1429	1597	1429		1597	4590	1393	1597	4590	1429
Flt Permitted	0.75	1.00	1.00	0.75	1.00		0.18	1.00	1.00	0.24	1.00	1.00
Satd. Flow (perm)	1266	1681	1429	1267	1429		300	4590	1393	395	4590	1429
Peak-hour factor, PHF	0.80	0.80	0.80	0.69	0.69	0.69	0.98	0.98	0.98	0.92	0.92	0.92
Adj. Flow (vph)	194	6	362	7	0	7	260	1148	10	11	1076	152
RTOR Reduction (vph)	0	0	213	0	6	0	0	0	4	0	0	87
Lane Group Flow (vph)	194	6	150	7	1	0	260	1148	6	11	1076	65
Confl. Peds. (#/hr)									6	6		
Turn Type	Perm	NA	Perm	Perm	NA		pm+pt	NA	Perm	pm+pt	NA	Perm
Protected Phases		4			8		5	2		1	6	
Permitted Phases	4		4	8			2		2	6		6
Actuated Green, G (s)	19.2	19.2	19.2	19.2	19.2		62.2	54.0	54.0	42.7	41.5	41.5
Effective Green, g (s)	19.2	19.2	19.2	19.2	19.2		62.2	54.0	54.0	42.7	41.5	41.5
Actuated g/C Ratio	0.20	0.20	0.20	0.20	0.20		0.65	0.56	0.56	0.44	0.43	0.43
Clearance Time (s)	7.0	7.0	7.0	7.0	7.0		7.0	8.0	8.0	7.0	8.0	8.0
Vehicle Extension (s)	3.0	3.0	3.0	3.0	3.0		3.0	3.0	3.0	3.0	3.0	3.0
Lane Grp Cap (vph)	252	334	284	252	284		377	2571	780	189	1975	615
v/s Ratio Prot		0.00			0.00		c0.10	0.25		0.00	0.23	
v/s Ratio Perm	c0.15		0.10	0.01			c0.35		0.00	0.02		0.05
v/c Ratio	0.77	0.02	0.53	0.03	0.00		0.69	0.45	0.01	0.06	0.54	0.11
Uniform Delay, d1	36.5	31.0	34.5	31.1	30.9		10.0	12.4	9.4	15.1	20.4	16.4
Progression Factor	1.00	1.00	1.00	1.00	1.00		1.00	1.00	1.00	1.00	1.00	1.00
Incremental Delay, d2	13.2	0.0	1.8	0.0	0.0		5.2	0.1	0.0	0.1	0.3	0.1
Delay (s)	49.7	31.0	36.3	31.1	30.9		15.2	12.6	9.4	15.2	20.7	16.5
Level of Service	D	C	D	C	C		B	B	A	B	C	B
Approach Delay (s)		40.9			31.0			13.0			20.2	
Approach LOS		D			C			B			C	

Intersection Summary

HCM 2000 Control Delay	20.7	HCM 2000 Level of Service	C
HCM 2000 Volume to Capacity ratio	0.74		
Actuated Cycle Length (s)	96.4	Sum of lost time (s)	22.0
Intersection Capacity Utilization	76.9%	ICU Level of Service	D
Analysis Period (min)	15		
c Critical Lane Group			

HCM Signalized Intersection Capacity Analysis

6: CO 83 & North Gate Blvd

09/01/2021

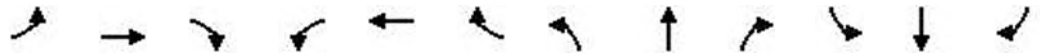

Movement	EBL	EBT	EBR	WBL	WBT	WBR	NBL	NBT	NBR	SBL	SBT	SBR
Lane Configurations												
Traffic Volume (vph)	110	10	480	10	5	5	455	830	20	15	665	95
Future Volume (vph)	110	10	480	10	5	5	455	830	20	15	665	95
Ideal Flow (vphpl)	1900	1900	1900	1900	1900	1900	1900	1900	1900	1900	1900	1900
Total Lost time (s)	6.0	6.0	6.0		6.0		5.0	7.0		7.0	7.0	7.0
Lane Util. Factor	1.00	1.00	1.00		1.00		0.97	0.95		1.00	0.95	1.00
Frbp, ped/bikes	1.00	1.00	1.00		1.00		1.00	1.00		1.00	1.00	1.00
Flpb, ped/bikes	1.00	1.00	1.00		1.00		1.00	1.00		1.00	1.00	1.00
Frt	1.00	1.00	0.85		0.97		1.00	1.00		1.00	1.00	0.85
Flt Protected	0.95	1.00	1.00		0.98		0.95	1.00		0.95	1.00	1.00
Satd. Flow (prot)	1438	1513	1286		1427		2789	2864		1433	2875	1286
Flt Permitted	0.73	1.00	1.00		0.87		0.95	1.00		0.32	1.00	1.00
Satd. Flow (perm)	1106	1513	1286		1276		2789	2864		476	2875	1286
Peak-hour factor, PHF	0.92	0.92	0.92	0.50	0.50	0.50	0.94	0.94	0.94	0.96	0.96	0.96
Adj. Flow (vph)	120	11	522	20	10	10	484	883	21	16	693	99
RTOR Reduction (vph)	0	0	409	0	8	0	0	1	0	0	0	52
Lane Group Flow (vph)	120	11	113	0	32	0	484	903	0	16	693	47
Confl. Peds. (#/hr)									7	7		
Turn Type	Perm	NA	Perm	Perm	NA		Prot	NA		Perm	NA	Perm
Protected Phases		4			8		5	2			6	
Permitted Phases	4		4	8						6		6
Actuated Green, G (s)	20.5	20.5	20.5		20.5		24.9	86.5		56.6	56.6	56.6
Effective Green, g (s)	20.5	20.5	20.5		20.5		24.9	86.5		56.6	56.6	56.6
Actuated g/C Ratio	0.17	0.17	0.17		0.17		0.21	0.72		0.47	0.47	0.47
Clearance Time (s)	6.0	6.0	6.0		6.0		5.0	7.0		7.0	7.0	7.0
Vehicle Extension (s)	3.0	3.0	3.0		3.0		3.0	3.0		3.0	3.0	3.0
Lane Grp Cap (vph)	188	258	219		217		578	2064		224	1356	606
v/s Ratio Prot		0.01					c0.17	0.32			c0.24	
v/s Ratio Perm	c0.11		0.09		0.02					0.03		0.04
v/c Ratio	0.64	0.04	0.52		0.15		0.84	0.44		0.07	0.51	0.08
Uniform Delay, d1	46.3	41.6	45.2		42.3		45.6	6.8		17.3	22.1	17.4
Progression Factor	1.00	1.00	1.00		1.00		1.00	1.00		1.00	1.00	1.00
Incremental Delay, d2	6.9	0.1	2.1		0.3		10.2	0.7		0.6	1.4	0.2
Delay (s)	53.2	41.6	47.3		42.6		55.8	7.5		17.9	23.4	17.6
Level of Service	D	D	D		D		E	A		B	C	B
Approach Delay (s)		48.3			42.6			24.4			22.6	
Approach LOS		D			D			C			C	

Intersection Summary

HCM 2000 Control Delay	29.5	HCM 2000 Level of Service	C
HCM 2000 Volume to Capacity ratio	0.62		
Actuated Cycle Length (s)	120.0	Sum of lost time (s)	18.0
Intersection Capacity Utilization	74.3%	ICU Level of Service	D
Analysis Period (min)	15		
c Critical Lane Group			

HCM Signalized Intersection Capacity Analysis

7: CO 83 & Old North Gate Rd

09/01/2021



Movement	EBL	EBT	EBR	WBL	WBT	WBR	NBL	NBT	NBR	SBL	SBT	SBR
Lane Configurations												
Traffic Volume (vph)	5	15	125	20	5	15	225	860	25	20	760	5
Future Volume (vph)	5	15	125	20	5	15	225	860	25	20	760	5
Ideal Flow (vphpl)	1900	1900	1900	1900	1900	1900	1900	1900	1900	1900	1900	1900
Total Lost time (s)	6.0	6.0		6.0	6.0		5.0	7.0	7.0	7.0	7.0	7.0
Lane Util. Factor	1.00	1.00		1.00	1.00		1.00	0.95	1.00	1.00	0.95	1.00
Frt	1.00	0.86		1.00	0.89		1.00	1.00	0.85	1.00	1.00	0.85
Flt Protected	0.95	1.00		0.95	1.00		0.95	1.00	1.00	0.95	1.00	1.00
Satd. Flow (prot)	1597	1452		1597	1489		1597	3195	1429	1597	3195	1429
Flt Permitted	0.74	1.00		0.46	1.00		0.30	1.00	1.00	0.30	1.00	1.00
Satd. Flow (perm)	1250	1452		773	1489		510	3195	1429	509	3195	1429
Peak-hour factor, PHF	0.78	0.92	0.78	0.92	0.92	0.92	0.91	0.91	0.92	0.92	0.94	0.94
Adj. Flow (vph)	6	16	160	22	5	16	247	945	27	22	809	5
RTOR Reduction (vph)	0	147	0	0	15	0	0	0	6	0	0	2
Lane Group Flow (vph)	6	29	0	22	6	0	247	945	21	22	809	3
Turn Type	Perm	NA		Perm	NA		pm+pt	NA	Perm	Perm	NA	Perm
Protected Phases		4			8		5	2			6	
Permitted Phases	4			8			2		2	6		6
Actuated Green, G (s)	8.7	8.7		8.7	8.7		83.1	83.1	83.1	68.8	68.8	68.8
Effective Green, g (s)	8.7	8.7		8.7	8.7		83.1	83.1	83.1	68.8	68.8	68.8
Actuated g/C Ratio	0.08	0.08		0.08	0.08		0.79	0.79	0.79	0.66	0.66	0.66
Clearance Time (s)	6.0	6.0		6.0	6.0		5.0	7.0	7.0	7.0	7.0	7.0
Vehicle Extension (s)	3.0	3.0		3.0	3.0		3.0	3.0	3.0	3.0	3.0	3.0
Lane Grp Cap (vph)	103	120		64	123		500	2533	1133	334	2097	938
v/s Ratio Prot		0.02			0.00		c0.04	0.30			0.25	
v/s Ratio Perm	0.00			c0.03			c0.35		0.01	0.04		0.00
v/c Ratio	0.06	0.24		0.34	0.05		0.49	0.37	0.02	0.07	0.39	0.00
Uniform Delay, d1	44.3	45.0		45.4	44.3		3.4	3.2	2.3	6.5	8.3	6.2
Progression Factor	1.00	1.00		1.00	1.00		1.00	1.00	1.00	1.00	1.00	1.00
Incremental Delay, d2	0.2	1.1		3.2	0.2		0.8	0.4	0.0	0.4	0.5	0.0
Delay (s)	44.5	46.0		48.6	44.4		4.1	3.6	2.3	6.8	8.8	6.2
Level of Service	D	D		D	D		A	A	A	A	A	A
Approach Delay (s)		46.0			46.5			3.7			8.8	
Approach LOS		D			D			A			A	

Intersection Summary

HCM 2000 Control Delay	9.7	HCM 2000 Level of Service	A
HCM 2000 Volume to Capacity ratio	0.50		
Actuated Cycle Length (s)	104.8	Sum of lost time (s)	18.0
Intersection Capacity Utilization	76.2%	ICU Level of Service	D
Analysis Period (min)	15		

c Critical Lane Group

Intersection Sign configuration not allowed in HCM analysis.

HCM Signalized Intersection Capacity Analysis

9: CO 83 & Kaessner Lane/#75

09/01/2021



Movement	EBL	EBT	EBR	WBL	WBT	WBR	NBL	NBT	NBR	SBL	SBT	SBR
Lane Configurations		↔		↔	↔		↔	↕	↔	↔	↕	↔
Traffic Volume (vph)	5	5	10	10	1	15	10	845	25	15	765	5
Future Volume (vph)	5	5	10	10	1	15	10	845	25	15	765	5
Ideal Flow (vphpl)	1900	1900	1900	1900	1900	1900	1900	1900	1900	1900	1900	1900
Total Lost time (s)		6.0		6.0	6.0		7.0	7.0	7.0	7.0	7.0	
Lane Util. Factor		1.00		1.00	1.00		1.00	0.95	1.00	1.00	0.95	
Frt		0.92		1.00	0.86		1.00	1.00	0.85	1.00	1.00	
Flt Protected		0.99		0.95	1.00		0.95	1.00	1.00	0.95	1.00	
Satd. Flow (prot)		1526		1597	1444		1597	3195	1429	1597	3192	
Flt Permitted		1.00		1.00	1.00		0.33	1.00	1.00	0.31	1.00	
Satd. Flow (perm)		1548		1681	1444		561	3195	1429	523	3192	
Peak-hour factor, PHF	0.44	0.92	0.44	0.92	0.92	0.92	0.92	0.92	0.92	0.92	0.91	0.91
Adj. Flow (vph)	11	5	23	11	1	16	11	918	27	16	841	5
RTOR Reduction (vph)	0	22	0	0	16	0	0	0	8	0	0	0
Lane Group Flow (vph)	0	17	0	11	1	0	11	918	19	16	846	0
Turn Type	Perm	NA		Perm	NA		Perm	NA	Perm	Perm	NA	
Protected Phases		4			8			2			6	
Permitted Phases	4			8			2		2	6		
Actuated Green, G (s)		1.4		1.4	1.4		31.5	31.5	31.5	31.5	31.5	
Effective Green, g (s)		1.4		1.4	1.4		31.5	31.5	31.5	31.5	31.5	
Actuated g/C Ratio		0.03		0.03	0.03		0.69	0.69	0.69	0.69	0.69	
Clearance Time (s)		6.0		6.0	6.0		7.0	7.0	7.0	7.0	7.0	
Vehicle Extension (s)		3.0		3.0	3.0		3.0	3.0	3.0	3.0	3.0	
Lane Grp Cap (vph)		47		51	44		385	2192	980	358	2190	
v/s Ratio Prot					0.00			c0.29			0.26	
v/s Ratio Perm		c0.01		0.01			0.02		0.01	0.03		
v/c Ratio		0.36		0.22	0.03		0.03	0.42	0.02	0.04	0.39	
Uniform Delay, d1		21.8		21.7	21.6		2.3	3.2	2.3	2.3	3.1	
Progression Factor		1.00		1.00	1.00		1.00	1.00	1.00	1.00	1.00	
Incremental Delay, d2		4.6		2.1	0.3		0.0	0.1	0.0	0.1	0.1	
Delay (s)		26.4		23.8	21.9		2.3	3.3	2.3	2.4	3.2	
Level of Service		C		C	C		A	A	A	A	A	
Approach Delay (s)		26.4			22.7			3.3			3.2	
Approach LOS		C			C			A			A	





















Intersection Summary

HCM 2000 Control Delay	4.0	HCM 2000 Level of Service	A
HCM 2000 Volume to Capacity ratio	0.42		
Actuated Cycle Length (s)	45.9	Sum of lost time (s)	13.0
Intersection Capacity Utilization	60.0%	ICU Level of Service	B
Analysis Period (min)	15		

c Critical Lane Group

HCM Signalized Intersection Capacity Analysis
 10: CO 83 & Stagecoach Rd

09/01/2021

													
Movement	EBL	EBT	EBR	WBL	WBT	WBR	NBL	NBT	NBR	SBL	SBT	SBR	
Lane Configurations													
Traffic Volume (vph)	1	0	5	110	5	55	5	775	115	65	655	1	
Future Volume (vph)	1	0	5	110	5	55	5	775	115	65	655	1	
Ideal Flow (vphpl)	1900	1900	1900	1900	1900	1900	1900	1900	1900	1900	1900	1900	
Total Lost time (s)		6.0			6.0	6.0	7.0	7.0	7.0	5.0	7.0		
Lane Util. Factor		1.00			1.00	1.00	1.00	0.95	1.00	1.00	0.95		
Frt		0.89			1.00	0.85	1.00	1.00	0.85	1.00	1.00		
Flt Protected		0.99			0.95	1.00	0.95	1.00	1.00	0.95	1.00		
Satd. Flow (prot)		1480			1605	1429	1597	3195	1429	1597	3194		
Flt Permitted		0.95			0.73	1.00	0.37	1.00	1.00	0.27	1.00		
Satd. Flow (perm)		1420			1222	1429	625	3195	1429	460	3194		
Peak-hour factor, PHF	0.50	0.50	0.50	0.83	0.83	0.83	0.90	0.90	0.90	0.89	0.89	0.89	
Adj. Flow (vph)	2	0	10	133	6	66	6	861	128	73	736	1	
RTOR Reduction (vph)	0	10	0	0	0	56	0	0	50	0	0	0	
Lane Group Flow (vph)	0	2	0	0	139	10	6	861	78	73	737	0	
Turn Type	Perm	NA		Perm	NA	Perm	Perm	NA	Perm	pm+pt	NA		
Protected Phases		4			8			2		1	6		
Permitted Phases	4			8		8	2		2	6			
Actuated Green, G (s)		14.7			14.7	14.7	59.5	59.5	59.5	70.1	70.1		
Effective Green, g (s)		14.7			14.7	14.7	59.5	59.5	59.5	70.1	70.1		
Actuated g/C Ratio		0.15			0.15	0.15	0.61	0.61	0.61	0.72	0.72		
Clearance Time (s)		6.0			6.0	6.0	7.0	7.0	7.0	5.0	7.0		
Vehicle Extension (s)		3.0			3.0	3.0	3.0	3.0	3.0	3.0	3.0		
Lane Grp Cap (vph)		213			183	214	380	1943	869	394	2289		
v/s Ratio Prot								c0.27		0.01	c0.23		
v/s Ratio Perm		0.00			c0.11	0.01	0.01		0.05	0.12			
v/c Ratio		0.01			0.76	0.05	0.02	0.44	0.09	0.19	0.32		
Uniform Delay, d1		35.3			39.9	35.6	7.6	10.3	7.9	4.8	5.1		
Progression Factor		1.00			1.00	1.00	1.00	1.00	1.00	1.00	1.00		
Incremental Delay, d2		0.0			16.5	0.1	0.1	0.7	0.2	0.2	0.4		
Delay (s)		35.4			56.3	35.6	7.6	11.0	8.1	5.0	5.5		
Level of Service		D			E	D	A	B	A	A	A		
Approach Delay (s)		35.4			49.7			10.6			5.4		
Approach LOS		D			D			B			A		
Intersection Summary													
HCM 2000 Control Delay			12.6									HCM 2000 Level of Service	B
HCM 2000 Volume to Capacity ratio			0.50										
Actuated Cycle Length (s)			97.8									Sum of lost time (s)	18.0
Intersection Capacity Utilization			68.0%									ICU Level of Service	C
Analysis Period (min)			15										

c Critical Lane Group

HCM Unsignalized Intersection Capacity Analysis

11: CO 83 & #79

09/01/2021



Movement	EBL	EBR	NBL	NBT	SBT	SBR
Lane Configurations						
Traffic Volume (veh/h)	0	5	10	830	720	5
Future Volume (Veh/h)	0	5	10	830	720	5
Sign Control	Stop			Free	Free	
Grade	0%			0%	0%	
Peak Hour Factor	0.92	0.92	0.92	0.92	0.92	0.92
Hourly flow rate (vph)	0	5	11	902	783	5
Pedestrians						
Lane Width (ft)						
Walking Speed (ft/s)						
Percent Blockage						
Right turn flare (veh)						
Median type				None	None	
Median storage (veh)						
Upstream signal (ft)						
pX, platoon unblocked						
vC, conflicting volume	1258	394	788			
vC1, stage 1 conf vol						
vC2, stage 2 conf vol						
vCu, unblocked vol	1258	394	788			
tC, single (s)	7.1	7.2	4.4			
tC, 2 stage (s)						
tF (s)	3.6	3.4	2.3			
p0 queue free %	100	99	99			
cM capacity (veh/h)	146	575	759			
Direction, Lane #	EB 1	NB 1	NB 2	NB 3	SB 1	SB 2
Volume Total	5	11	451	451	522	266
Volume Left	0	11	0	0	0	0
Volume Right	5	0	0	0	0	5
cSH	575	759	1700	1700	1700	1700
Volume to Capacity	0.01	0.01	0.27	0.27	0.31	0.16
Queue Length 95th (ft)	1	1	0	0	0	0
Control Delay (s)	11.3	9.8	0.0	0.0	0.0	0.0
Lane LOS	B	A				
Approach Delay (s)	11.3	0.1	0.0			
Approach LOS	B					
Intersection Summary						
Average Delay			0.1			
Intersection Capacity Utilization			30.1%	ICU Level of Service	A	
Analysis Period (min)			15			

HCM Signalized Intersection Capacity Analysis

12: CO 83 & High Forest Rd

09/01/2021

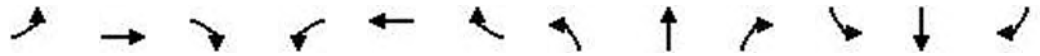

Movement	EBL	EBT	EBR	WBL	WBT	WBR	NBL	NBT	NBR	SBL	SBT	SBR
Lane Configurations		↕		↕	↕		↕	↕↕	↕	↕	↕↕	
Traffic Volume (vph)	15	1	11	45	0	10	15	775	60	5	670	5
Future Volume (vph)	15	1	11	45	0	10	15	775	60	5	670	5
Ideal Flow (vphpl)	1900	1900	1900	1900	1900	1900	1900	1900	1900	1900	1900	1900
Total Lost time (s)		6.0		6.0	6.0		5.0	7.0	7.0	5.0	7.0	
Lane Util. Factor		1.00		1.00	1.00		1.00	0.95	1.00	1.00	0.95	
Frt		0.94		1.00	0.85		1.00	1.00	0.85	1.00	1.00	
Flt Protected		0.97		0.95	1.00		0.95	1.00	1.00	0.95	1.00	
Satd. Flow (prot)		1545		1597	1429		1597	3195	1429	1597	3192	
Flt Permitted		0.82		0.74	1.00		0.36	1.00	1.00	0.33	1.00	
Satd. Flow (perm)		1302		1241	1429		612	3195	1429	551	3192	
Peak-hour factor, PHF	0.92	0.92	0.92	0.66	0.92	0.66	0.92	0.93	0.93	0.89	0.89	0.92
Adj. Flow (vph)	16	1	12	68	0	15	16	833	65	6	753	5
RTOR Reduction (vph)	0	11	0	0	13	0	0	0	29	0	0	0
Lane Group Flow (vph)	0	18	0	68	2	0	16	833	36	6	758	0
Turn Type	Perm	NA		Perm	NA		pm+pt	NA	Perm	pm+pt	NA	
Protected Phases		4			8		5	2		1	6	
Permitted Phases	4			8			2		2	6		
Actuated Green, G (s)		5.8		5.8	5.8		32.0	31.1	31.1	32.0	31.1	
Effective Green, g (s)		5.8		5.8	5.8		32.0	31.1	31.1	32.0	31.1	
Actuated g/C Ratio		0.10		0.10	0.10		0.57	0.56	0.56	0.57	0.56	
Clearance Time (s)		6.0		6.0	6.0		5.0	7.0	7.0	5.0	7.0	
Vehicle Extension (s)		3.0		3.0	3.0		3.0	3.0	3.0	3.0	3.0	
Lane Grp Cap (vph)		135		128	148		366	1780	796	332	1779	
v/s Ratio Prot					0.00		c0.00	c0.26		0.00	0.24	
v/s Ratio Perm		0.01		c0.05			0.02		0.03	0.01		
v/c Ratio		0.14		0.53	0.01		0.04	0.47	0.05	0.02	0.43	
Uniform Delay, d1		22.7		23.7	22.4		5.1	7.4	5.6	5.1	7.2	
Progression Factor		1.00		1.00	1.00		1.00	1.00	1.00	1.00	1.00	
Incremental Delay, d2		0.5		4.2	0.0		0.0	0.2	0.0	0.0	0.2	
Delay (s)		23.2		27.9	22.5		5.2	7.6	5.6	5.1	7.3	
Level of Service		C		C	C		A	A	A	A	A	
Approach Delay (s)		23.2			26.9			7.4			7.3	
Approach LOS		C			C			A			A	

Intersection Summary

HCM 2000 Control Delay	8.5	HCM 2000 Level of Service	A
HCM 2000 Volume to Capacity ratio	0.47		
Actuated Cycle Length (s)	55.8	Sum of lost time (s)	18.0
Intersection Capacity Utilization	44.2%	ICU Level of Service	A
Analysis Period (min)	15		

c Critical Lane Group

HCM Signalized Intersection Capacity Analysis

13: CO 83 & Hogden Rd

09/01/2021

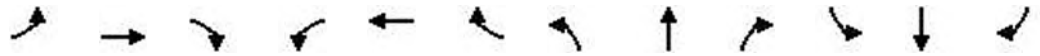

Movement	EBL	EBT	EBR	WBL	WBT	WBR	NBL	NBT	NBR	SBL	SBT	SBR
Lane Configurations												
Traffic Volume (vph)	45	245	75	180	135	180	105	420	260	390	442	75
Future Volume (vph)	45	245	75	180	135	180	105	420	260	390	442	75
Ideal Flow (vphpl)	1900	1900	1900	1900	1900	1900	1900	1900	1900	1900	1900	1900
Total Lost time (s)	6.0	6.0	6.0	6.0	6.0	6.0	6.0	7.0	7.0	6.0	7.0	
Lane Util. Factor	1.00	1.00	1.00	1.00	1.00	1.00	1.00	1.00	1.00	1.00	1.00	
Frt	1.00	1.00	0.85	1.00	1.00	0.85	1.00	1.00	0.85	1.00	0.98	
Flt Protected	0.95	1.00	1.00	0.95	1.00	1.00	0.95	1.00	1.00	0.95	1.00	
Satd. Flow (prot)	1597	1681	1429	1597	1681	1429	1597	1681	1429	1597	1645	
Flt Permitted	0.95	1.00	1.00	0.95	1.00	1.00	0.36	1.00	1.00	0.17	1.00	
Satd. Flow (perm)	1597	1681	1429	1597	1681	1429	613	1681	1429	294	1645	
Peak-hour factor, PHF	0.92	0.92	0.92	0.79	0.79	0.79	0.95	0.95	0.95	0.89	0.89	0.89
Adj. Flow (vph)	49	266	82	228	171	228	111	442	274	438	497	84
RTOR Reduction (vph)	0	0	69	0	0	194	0	0	191	0	5	0
Lane Group Flow (vph)	49	266	13	228	171	34	111	442	83	438	576	0
Turn Type	Split	NA	Perm	Split	NA	Perm	pm+pt	NA	Perm	pm+pt	NA	
Protected Phases	4	4		8	8		5	2		1	6	
Permitted Phases			4			8	2		2	6		
Actuated Green, G (s)	21.0	21.0	21.0	19.0	19.0	19.0	43.7	37.7	37.7	69.7	57.7	
Effective Green, g (s)	21.0	21.0	21.0	19.0	19.0	19.0	43.7	37.7	37.7	69.7	57.7	
Actuated g/C Ratio	0.16	0.16	0.16	0.15	0.15	0.15	0.34	0.29	0.29	0.54	0.45	
Clearance Time (s)	6.0	6.0	6.0	6.0	6.0	6.0	6.0	7.0	7.0	6.0	7.0	
Vehicle Extension (s)	3.0	3.0	3.0	3.0	3.0	3.0	3.0	3.0	3.0	3.0	3.0	
Lane Grp Cap (vph)	260	274	233	235	248	210	254	492	418	422	737	
v/s Ratio Prot	0.03	c0.16		c0.14	0.10		0.02	0.26		c0.21	0.35	
v/s Ratio Perm			0.01			0.02	0.13		0.06	c0.35		
v/c Ratio	0.19	0.97	0.06	0.97	0.69	0.16	0.44	0.90	0.20	1.04	0.78	
Uniform Delay, d1	46.5	53.5	45.5	54.6	52.1	47.9	30.7	43.7	34.2	32.5	30.1	
Progression Factor	1.00	1.00	1.00	1.00	1.00	1.00	1.00	1.00	1.00	1.00	1.00	
Incremental Delay, d2	0.4	46.1	0.1	50.1	7.8	0.4	1.2	18.9	0.2	54.0	5.4	
Delay (s)	46.8	99.7	45.6	104.7	59.8	48.2	31.9	62.5	34.4	86.5	35.6	
Level of Service	D	F	D	F	E	D	C	E	C	F	D	
Approach Delay (s)		82.0			71.9			49.1			57.4	
Approach LOS		F			E			D			E	

Intersection Summary

HCM 2000 Control Delay	61.6	HCM 2000 Level of Service	E
HCM 2000 Volume to Capacity ratio	1.04		
Actuated Cycle Length (s)	128.7	Sum of lost time (s)	25.0
Intersection Capacity Utilization	94.5%	ICU Level of Service	F
Analysis Period (min)	15		

c Critical Lane Group

HCM Signalized Intersection Capacity Analysis

14: CO 83 & #79

09/01/2021



Movement	EBL	EBT	EBR	WBL	WBT	WBR	NBL	NBT	NBR	SBL	SBT	SBR
Lane Configurations		↕		↖	↗			↗		↖	↗	
Traffic Volume (vph)	5	0	5	15	0	10	0	645	10	20	915	0
Future Volume (vph)	5	0	5	15	0	10	0	645	10	20	915	0
Ideal Flow (vphpl)	1900	1900	1900	1900	1900	1900	1900	1900	1900	1900	1900	1900
Total Lost time (s)		6.0		6.0	6.0			7.0		7.0	7.0	
Lane Util. Factor		1.00		1.00	1.00			1.00		1.00	1.00	
Frt		0.93		1.00	0.85			1.00		1.00	1.00	
Flt Protected		0.98		0.95	1.00			1.00		0.95	1.00	
Satd. Flow (prot)		1530		1597	1429			1678		1597	1681	
Flt Permitted		0.97		1.00	1.00			1.00		0.37	1.00	
Satd. Flow (perm)		1517		1681	1429			1678		625	1681	
Peak-hour factor, PHF	0.92	0.92	0.92	0.92	0.92	0.92	0.92	0.92	0.92	0.92	0.92	0.92
Adj. Flow (vph)	5	0	5	16	0	11	0	701	11	22	995	0
RTOR Reduction (vph)	0	10	0	0	11	0	0	0	0	0	0	0
Lane Group Flow (vph)	0	0	0	16	0	0	0	712	0	22	995	0
Turn Type	Perm	NA		Perm	NA			NA		Perm	NA	
Protected Phases		4			8			2			6	
Permitted Phases	4			8						6		
Actuated Green, G (s)		3.1		3.1	3.1			61.5		61.5	61.5	
Effective Green, g (s)		3.1		3.1	3.1			61.5		61.5	61.5	
Actuated g/C Ratio		0.04		0.04	0.04			0.79		0.79	0.79	
Clearance Time (s)		6.0		6.0	6.0			7.0		7.0	7.0	
Vehicle Extension (s)		3.0		3.0	3.0			3.0		3.0	3.0	
Lane Grp Cap (vph)		60		67	57			1329		495	1332	
v/s Ratio Prot					0.00			0.42			c0.59	
v/s Ratio Perm		0.00		c0.01						0.04		
v/c Ratio		0.01		0.24	0.01			0.54		0.04	0.75	
Uniform Delay, d1		35.8		36.1	35.8			2.9		1.7	4.1	
Progression Factor		1.00		1.00	1.00			1.00		1.00	1.00	
Incremental Delay, d2		0.0		1.8	0.1			1.5		0.2	3.9	
Delay (s)		35.8		38.0	35.8			4.5		1.9	8.0	
Level of Service		D		D	D			A		A	A	
Approach Delay (s)		35.8			37.1			4.5			7.8	
Approach LOS		D			D			A			A	

Intersection Summary

HCM 2000 Control Delay	7.1	HCM 2000 Level of Service	A
HCM 2000 Volume to Capacity ratio	0.72		
Actuated Cycle Length (s)	77.6	Sum of lost time (s)	13.0
Intersection Capacity Utilization	64.1%	ICU Level of Service	C
Analysis Period (min)	15		

c Critical Lane Group

HCM Signalized Intersection Capacity Analysis

15: CO 83 & Walden Way

09/01/2021

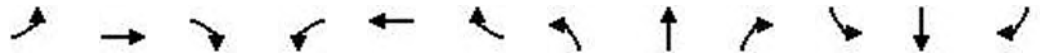

Movement	EBL	EBT	EBR	WBL	WBT	WBR	NBL	NBT	NBR	SBL	SBT	SBR
Lane Configurations		↕		↕	↕		↕	↕		↕	↕	
Traffic Volume (vph)	10	1	5	5	0	15	20	705	10	10	915	15
Future Volume (vph)	10	1	5	5	0	15	20	705	10	10	915	15
Ideal Flow (vphpl)	1900	1900	1900	1900	1900	1900	1900	1900	1900	1900	1900	1900
Total Lost time (s)		6.0		6.0	6.0		7.0	7.0		5.0	7.0	
Lane Util. Factor		1.00		1.00	1.00		1.00	1.00		1.00	1.00	
Frt		0.96		1.00	0.85		1.00	1.00		1.00	1.00	
Flt Protected		0.97		0.95	1.00		0.95	1.00		0.95	1.00	
Satd. Flow (prot)		1564		1597	1429		1597	1678		1597	1677	
Flt Permitted		1.00		1.00	1.00		0.27	1.00		0.21	1.00	
Satd. Flow (perm)		1615		1681	1429		450	1678		355	1677	
Peak-hour factor, PHF	0.92	0.92	0.92	0.75	0.92	0.75	0.92	0.76	0.76	0.93	0.93	0.92
Adj. Flow (vph)	11	1	5	7	0	20	22	928	13	11	984	16
RTOR Reduction (vph)	0	5	0	0	19	0	0	0	0	0	0	0
Lane Group Flow (vph)	0	12	0	7	1	0	22	941	0	11	1000	0
Turn Type	Perm	NA		Perm	NA		Perm	NA		pm+pt	NA	
Protected Phases		4			8			2		1	6	
Permitted Phases	4			8			2			6		
Actuated Green, G (s)		2.7		2.7	2.7		59.6	59.6		65.6	65.6	
Effective Green, g (s)		2.7		2.7	2.7		59.6	59.6		65.6	65.6	
Actuated g/C Ratio		0.03		0.03	0.03		0.73	0.73		0.81	0.81	
Clearance Time (s)		6.0		6.0	6.0		7.0	7.0		5.0	7.0	
Vehicle Extension (s)		3.0		3.0	3.0		3.0	3.0		3.0	3.0	
Lane Grp Cap (vph)		53		55	47		329	1230		301	1353	
v/s Ratio Prot					0.00			0.56		0.00	c0.60	
v/s Ratio Perm		c0.01		0.00			0.05			0.03		
v/c Ratio		0.23		0.13	0.01		0.07	0.76		0.04	0.74	
Uniform Delay, d1		38.3		38.2	38.0		3.0	6.6		4.5	3.8	
Progression Factor		1.00		1.00	1.00		1.00	1.00		1.00	1.00	
Incremental Delay, d2		2.2		1.0	0.1		0.4	4.6		0.0	3.6	
Delay (s)		40.5		39.2	38.1		3.4	11.2		4.6	7.4	
Level of Service		D		D	D		A	B		A	A	
Approach Delay (s)		40.5			38.4			11.0			7.4	
Approach LOS		D			D			B			A	

Intersection Summary

HCM 2000 Control Delay	9.8	HCM 2000 Level of Service	A
HCM 2000 Volume to Capacity ratio	0.78		
Actuated Cycle Length (s)	81.3	Sum of lost time (s)	18.0
Intersection Capacity Utilization	67.5%	ICU Level of Service	C
Analysis Period (min)	15		

c Critical Lane Group

HCM Unsignalized Intersection Capacity Analysis
 16: CO 83 & Pinehurst RI only

09/01/2021



Movement	WBL	WBR	NBT	NBR	SBL	SBT
Lane Configurations			↑	↗		↑↑
Traffic Volume (veh/h)	0	0	705	45	0	925
Future Volume (Veh/h)	0	0	705	45	0	925
Sign Control	Stop		Free		Free	
Grade	0%		0%		0%	
Peak Hour Factor	0.92	0.92	0.92	0.92	0.92	0.92
Hourly flow rate (vph)	0	0	766	49	0	1005
Pedestrians						
Lane Width (ft)						
Walking Speed (ft/s)						
Percent Blockage						
Right turn flare (veh)						
Median type	None			None		
Median storage (veh)						
Upstream signal (ft)						
pX, platoon unblocked						
vC, conflicting volume	1268	766			815	
vC1, stage 1 conf vol						
vC2, stage 2 conf vol						
vCu, unblocked vol	1268	766			815	
tC, single (s)	7.1	7.2			4.4	
tC, 2 stage (s)						
tF (s)	3.6	3.4			2.3	
p0 queue free %	100	100			100	
cM capacity (veh/h)	146	322			741	
Direction, Lane #	NB 1	NB 2	SB 1	SB 2		
Volume Total	766	49	502	502		
Volume Left	0	0	0	0		
Volume Right	0	49	0	0		
cSH	1700	1700	1700	1700		
Volume to Capacity	0.45	0.03	0.30	0.30		
Queue Length 95th (ft)	0	0	0	0		
Control Delay (s)	0.0	0.0	0.0	0.0		
Lane LOS						
Approach Delay (s)	0.0		0.0			
Approach LOS						
Intersection Summary						
Average Delay			0.0			
Intersection Capacity Utilization			40.4%		ICU Level of Service	A
Analysis Period (min)			15			

HCM Signalized Intersection Capacity Analysis
 17: CO 83 & CR 105/Walker Rd

09/01/2021

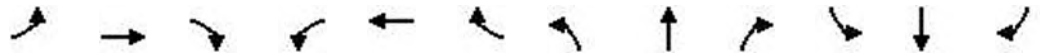

Movement	EBL	EBT	EBR	WBL	WBT	WBR	NBL	NBT	NBR	SBL	SBT	SBR
Lane Configurations												
Traffic Volume (vph)	240	145	85	95	155	40	235	405	65	35	745	120
Future Volume (vph)	240	145	85	95	155	40	235	405	65	35	745	120
Ideal Flow (vphpl)	1900	1900	1900	1900	1900	1900	1900	1900	1900	1900	1900	1900
Total Lost time (s)	4.5	6.0	4.0	4.5	6.0	6.0	5.0	7.0	7.0	5.0	7.0	7.0
Lane Util. Factor	1.00	0.95	1.00	1.00	0.95	1.00	1.00	1.00	1.00	1.00	1.00	1.00
Frt	1.00	1.00	0.85	1.00	1.00	0.85	1.00	1.00	0.85	1.00	1.00	0.85
Flt Protected	0.95	1.00	1.00	0.95	1.00	1.00	0.95	1.00	1.00	0.95	1.00	1.00
Satd. Flow (prot)	1597	3195	1429	1597	3195	1429	1597	1681	1429	1597	1681	1429
Flt Permitted	0.38	1.00	1.00	0.65	1.00	1.00	0.12	1.00	1.00	0.47	1.00	1.00
Satd. Flow (perm)	641	3195	1429	1100	3195	1429	198	1681	1429	783	1681	1429
Peak-hour factor, PHF	0.94	0.94	0.94	0.61	0.61	0.61	0.82	0.82	0.82	0.95	0.95	0.95
Adj. Flow (vph)	255	154	90	156	254	66	287	494	79	37	784	126
RTOR Reduction (vph)	0	0	0	0	0	61	0	0	34	0	0	63
Lane Group Flow (vph)	255	154	90	156	254	5	287	494	45	37	784	63
Turn Type	pm+pt	NA	Free	pm+pt	NA	Perm	pm+pt	NA	Perm	pm+pt	NA	Perm
Protected Phases	7	4		3	8		5	2		1	6	
Permitted Phases	4		Free	8		8	2		2	6		6
Actuated Green, G (s)	22.4	10.5	108.3	17.6	8.1	8.1	70.8	62.3	62.3	57.3	53.8	53.8
Effective Green, g (s)	22.4	10.5	108.3	17.6	8.1	8.1	70.8	62.3	62.3	57.3	53.8	53.8
Actuated g/C Ratio	0.21	0.10	1.00	0.16	0.07	0.07	0.65	0.58	0.58	0.53	0.50	0.50
Clearance Time (s)	4.5	6.0		4.5	6.0	6.0	5.0	7.0	7.0	5.0	7.0	7.0
Vehicle Extension (s)	3.0	3.0		3.0	3.0	3.0	3.0	3.0	3.0	3.0	3.0	3.0
Lane Grp Cap (vph)	237	309	1429	222	238	106	284	967	822	440	835	709
v/s Ratio Prot	c0.12	0.05		0.06	0.08		c0.11	0.29		0.00	0.47	
v/s Ratio Perm	c0.10		0.06	0.05		0.00	c0.55		0.03	0.04		0.04
v/c Ratio	1.08	0.50	0.06	0.70	1.07	0.05	1.01	0.51	0.06	0.08	0.94	0.09
Uniform Delay, d1	41.2	46.4	0.0	42.1	50.1	46.5	28.2	13.8	10.1	12.3	25.7	14.3
Progression Factor	1.00	1.00	1.00	1.00	1.00	1.00	1.00	1.00	1.00	1.00	1.00	1.00
Incremental Delay, d2	80.1	1.3	0.1	9.7	77.3	0.2	56.1	0.5	0.0	0.1	17.8	0.1
Delay (s)	121.3	47.7	0.1	51.7	127.4	46.7	84.3	14.3	10.1	12.4	43.5	14.4
Level of Service	F	D	A	D	F	D	F	B	B	B	D	B
Approach Delay (s)		76.7			91.4			37.3			38.4	
Approach LOS		E			F			D			D	

Intersection Summary

HCM 2000 Control Delay	54.0	HCM 2000 Level of Service	D
HCM 2000 Volume to Capacity ratio	1.09		
Actuated Cycle Length (s)	108.3	Sum of lost time (s)	22.5
Intersection Capacity Utilization	89.3%	ICU Level of Service	E
Analysis Period (min)	15		

c Critical Lane Group

HCM Signalized Intersection Capacity Analysis

18: CO 83 & #82/#81

09/01/2021

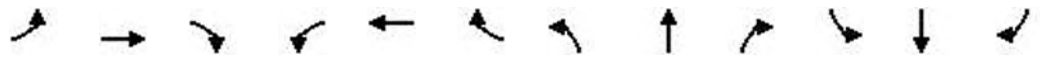

Movement	EBL	EBT	EBR	WBL	WBT	WBR	NBL	NBT	NBR	SBL	SBT	SBR
Lane Configurations		↕			↕		↗	↖		↗	↖	
Traffic Volume (vph)	15	5	20	25	1	20	20	675	20	30	870	10
Future Volume (vph)	15	5	20	25	1	20	20	675	20	30	870	10
Ideal Flow (vphpl)	1900	1900	1900	1900	1900	1900	1900	1900	1900	1900	1900	1900
Total Lost time (s)		6.0			6.0		7.0	7.0		7.0	7.0	
Lane Util. Factor		1.00			1.00		1.00	1.00		1.00	1.00	
Frt		0.93			0.94		1.00	1.00		1.00	1.00	
Flt Protected		0.98			0.97		0.95	1.00		0.95	1.00	
Satd. Flow (prot)		1537			1540		1597	1674		1597	1679	
Flt Permitted		0.86			0.81		0.25	1.00		0.35	1.00	
Satd. Flow (perm)		1340			1278		427	1674		582	1679	
Peak-hour factor, PHF	0.92	0.92	0.92	0.92	0.92	0.92	0.92	0.92	0.92	0.92	0.92	0.92
Adj. Flow (vph)	16	5	22	27	1	22	22	734	22	33	946	11
RTOR Reduction (vph)	0	21	0	0	21	0	0	1	0	0	0	0
Lane Group Flow (vph)	0	22	0	0	29	0	22	755	0	33	957	0
Turn Type	Perm	NA		Perm	NA		Perm	NA		Perm	NA	
Protected Phases		4			8			2			6	
Permitted Phases	4			8			2			6		
Actuated Green, G (s)		5.3			5.3		72.3	72.3		72.3	72.3	
Effective Green, g (s)		5.3			5.3		72.3	72.3		72.3	72.3	
Actuated g/C Ratio		0.06			0.06		0.80	0.80		0.80	0.80	
Clearance Time (s)		6.0			6.0		7.0	7.0		7.0	7.0	
Vehicle Extension (s)		3.0			3.0		3.0	3.0		3.0	3.0	
Lane Grp Cap (vph)		78			74		340	1335		464	1339	
v/s Ratio Prot								0.45			c0.57	
v/s Ratio Perm		0.02			c0.02		0.05			0.06		
v/c Ratio		0.29			0.40		0.06	0.57		0.07	0.71	
Uniform Delay, d1		40.8			41.1		1.9	3.4		2.0	4.3	
Progression Factor		1.00			1.00		1.00	1.00		1.00	1.00	
Incremental Delay, d2		2.0			3.5		0.4	1.7		0.3	3.3	
Delay (s)		42.9			44.6		2.3	5.1		2.3	7.6	
Level of Service		D			D		A	A		A	A	
Approach Delay (s)		42.9			44.6			5.0			7.4	
Approach LOS		D			D			A			A	

Intersection Summary

HCM 2000 Control Delay	8.2	HCM 2000 Level of Service	A
HCM 2000 Volume to Capacity ratio	0.69		
Actuated Cycle Length (s)	90.6	Sum of lost time (s)	13.0
Intersection Capacity Utilization	62.2%	ICU Level of Service	B
Analysis Period (min)	15		

c Critical Lane Group

HCM Signalized Intersection Capacity Analysis

19: CO 83

09/01/2021



Movement	EBL	EBR	NBL	NBT	SBT	SBR
Lane Configurations						
Traffic Volume (vph)	15	10	20	680	865	15
Future Volume (vph)	15	10	20	680	865	15
Ideal Flow (vphpl)	1900	1900	1900	1900	1900	1900
Total Lost time (s)	5.0	5.0	5.0	5.0	5.0	5.0
Lane Util. Factor	1.00	1.00	1.00	1.00	1.00	1.00
Frt	1.00	0.85	1.00	1.00	1.00	0.85
Flt Protected	0.95	1.00	0.95	1.00	1.00	1.00
Satd. Flow (prot)	1597	1429	1597	1681	1681	1429
Flt Permitted	0.95	1.00	0.27	1.00	1.00	1.00
Satd. Flow (perm)	1597	1429	460	1681	1681	1429
Peak-hour factor, PHF	0.92	0.92	0.92	0.92	0.92	0.92
Adj. Flow (vph)	16	11	22	739	940	16
RTOR Reduction (vph)	0	11	0	0	0	3
Lane Group Flow (vph)	16	0	22	739	940	13
Turn Type	Prot	Perm	Perm	NA	NA	Perm
Protected Phases	4			2	6	
Permitted Phases		4	2			6
Actuated Green, G (s)	2.9	2.9	63.9	63.9	63.9	63.9
Effective Green, g (s)	2.9	2.9	63.9	63.9	63.9	63.9
Actuated g/C Ratio	0.04	0.04	0.83	0.83	0.83	0.83
Clearance Time (s)	5.0	5.0	5.0	5.0	5.0	5.0
Vehicle Extension (s)	3.0	3.0	3.0	3.0	3.0	3.0
Lane Grp Cap (vph)	60	53	382	1398	1398	1188
v/s Ratio Prot	c0.01			0.44	c0.56	
v/s Ratio Perm		0.00	0.05			0.01
v/c Ratio	0.27	0.01	0.06	0.53	0.67	0.01
Uniform Delay, d1	35.9	35.6	1.1	1.9	2.5	1.1
Progression Factor	1.00	1.00	1.00	1.00	1.00	1.00
Incremental Delay, d2	2.4	0.1	0.3	1.4	2.6	0.0
Delay (s)	38.3	35.6	1.4	3.4	5.1	1.1
Level of Service	D	D	A	A	A	A
Approach Delay (s)	37.2			3.3	5.0	
Approach LOS	D			A	A	

Intersection Summary

HCM 2000 Control Delay	4.8	HCM 2000 Level of Service	A
HCM 2000 Volume to Capacity ratio	0.65		
Actuated Cycle Length (s)	76.8	Sum of lost time (s)	10.0
Intersection Capacity Utilization	58.9%	ICU Level of Service	B
Analysis Period (min)	15		

c Critical Lane Group

HCM Signalized Intersection Capacity Analysis
 20: CO 83 & E Palmer Divide Ave

09/01/2021



Movement	EBL	EBT	EBR	WBL	WBT	WBR	NBL	NBT	NBR	SBL	SBT	SBR
Lane Configurations												
Traffic Volume (vph)	40	55	120	60	30	5	65	360	130	25	690	75
Future Volume (vph)	40	55	120	60	30	5	65	360	130	25	690	75
Ideal Flow (vphpl)	1900	1900	1900	1900	1900	1900	1900	1900	1900	1900	1900	1900
Total Lost time (s)	4.5	7.0	7.0	4.5	7.0	7.0	4.5	8.0		4.5	8.0	
Lane Util. Factor	1.00	1.00	1.00	1.00	1.00	1.00	1.00	1.00		1.00	1.00	
Frt	1.00	1.00	0.85	1.00	1.00	0.85	1.00	0.96		1.00	0.99	
Flt Protected	0.95	1.00	1.00	0.95	1.00	1.00	0.95	1.00		0.95	1.00	
Satd. Flow (prot)	1597	1681	1429	1597	1681	1429	1597	1614		1597	1657	
Flt Permitted	0.73	1.00	1.00	0.66	1.00	1.00	0.18	1.00		0.32	1.00	
Satd. Flow (perm)	1231	1681	1429	1110	1681	1429	305	1614		544	1657	
Peak-hour factor, PHF	0.88	0.88	0.88	0.78	0.78	0.78	0.78	0.78	0.78	0.94	0.94	0.94
Adj. Flow (vph)	45	62	136	77	38	6	83	462	167	27	734	80
RTOR Reduction (vph)	0	0	120	0	0	5	0	8	0	0	3	0
Lane Group Flow (vph)	45	63	16	77	38	1	83	621	0	27	811	0
Turn Type	pm+pt	NA	Perm	pm+pt	NA	Perm	pm+pt	NA		pm+pt	NA	
Protected Phases	7	4		3	8		5	2		1	6	
Permitted Phases	4		4	8		8	2			6		
Actuated Green, G (s)	14.7	11.9	11.9	16.7	12.9	12.9	62.3	58.5		60.3	57.5	
Effective Green, g (s)	14.7	11.9	11.9	16.7	12.9	12.9	62.3	58.5		60.3	57.5	
Actuated g/C Ratio	0.15	0.12	0.12	0.17	0.13	0.13	0.62	0.58		0.60	0.57	
Clearance Time (s)	4.5	7.0	7.0	4.5	7.0	7.0	4.5	8.0		4.5	8.0	
Vehicle Extension (s)	3.0	5.0	5.0	3.0	5.0	5.0	3.0	5.0		3.0	5.0	
Lane Grp Cap (vph)	189	198	168	201	214	182	236	934		353	943	
v/s Ratio Prot	0.01	0.04		c0.01	0.02		c0.01	0.38		0.00	c0.49	
v/s Ratio Perm	0.03		0.01	c0.05		0.00	0.20			0.04		
v/c Ratio	0.24	0.32	0.10	0.38	0.18	0.00	0.35	0.66		0.08	0.86	
Uniform Delay, d1	37.9	40.8	39.7	37.1	39.3	38.4	12.6	14.5		9.3	18.4	
Progression Factor	1.00	1.00	1.00	1.00	1.00	1.00	1.00	1.00		1.00	1.00	
Incremental Delay, d2	0.7	1.9	0.5	1.2	0.8	0.0	0.9	2.4		0.1	8.8	
Delay (s)	38.6	42.8	40.3	38.3	40.1	38.5	13.5	16.9		9.4	27.2	
Level of Service	D	D	D	D	D	D	B	B		A	C	
Approach Delay (s)		40.6			38.9			16.5			26.6	
Approach LOS		D			D			B			C	

Intersection Summary

HCM 2000 Control Delay	25.4	HCM 2000 Level of Service	C
HCM 2000 Volume to Capacity ratio	0.74		
Actuated Cycle Length (s)	101.0	Sum of lost time (s)	24.0
Intersection Capacity Utilization	71.3%	ICU Level of Service	C
Analysis Period (min)	15		

c Critical Lane Group

This page intentionally left blank.

Appendix E. Public Involvement Material

E.1. Open House #1 Materials



COLORADO
Department of Transportation

WELCOME

to the

**CO 83 Access
Study**

Virtual Open House





COLORADO

Department of Transportation

CO 83 ACCESS STUDY



GENERAL INFORMATION



VIRTUAL MEETING FORMAT

- Please take your time and review the materials at each station within the virtual meeting room.
- The draft access recommendations maps are arranged from south to north to help make it easier to find your driveway/access point.
- We ask that you refer to the number from the maps when asking questions or providing comments about your driveway or access location. For example, if your driveway is #34 on the map, then please reference that number on your comment form.
- The project team will respond to all comments and questions in a timely manner and may reach out to you for clarification if needed.
- The open house is intended to be a self-paced review of project information, so there is no formal presentation by the project team.

FAQs FREQUENTLY ASKED QUESTIONS

○ **When can you expect changes in access to occur on CO 83?**

Currently, there are no plans to make any changes to access within the study area.

Changes will occur incrementally over time when the following occurs:

- A problem with traffic flow or safety is identified.
- Properties redevelop or change their existing land use.
- Funding for a roadway project is obtained, but at this time such funding does not exist.

In short, most changes will not occur in the near future and some of the changes may never occur if the conditions mentioned above are not satisfied (more information on this topic can be found at the Access Study Process station).

○ **Will the study recommend changing speed limits?**

No, making a change to a speed limit is not a recommendation of an access study.

Changes in speed limits are the result of a traffic study that evaluates the travel speed of vehicles using the highway and then recommends the proper speed limit for that portion of roadway.

○ **How much will the recommendations cost?**

The access study does not evaluate the cost of the proposed changes.

The cost of changes will vary from location to location based on the final design of the roadway, driveway, and intersection features, including number of lanes, the need for a traffic signal, and other roadway improvements.

Because the changes will occur in phases over a long period of time, the total cost of all the recommendations shown in the study is unknown.

○ **Will the study recommend a change to the highway classification?**

All highways have a classification that determines many features, including where and when access is allowed, maximum speed limits, the need for turn lanes, and the distance between traffic signals. More information can be found in the Existing Access Conditions on CO 83 station.

The access study is not recommending a change to the existing highway classification.

○ **Who do I talk to if I have a specific concern or issue related to the recommendations at my access location?**

You can complete a comment form with your questions/concerns and submit it to the project team, or you can reach out directly to Dave Sprague, Consultant, Project Manager at David.Sprague@atkinsglobal.com.

A project team member will contact you to discuss your concerns and may schedule additional meetings with you if needed.



COLORADO

Department of Transportation

CO 83 ACCESS STUDY

ACCESS STUDY OVERVIEW



ACCESS STUDY OVERVIEW

Study Area

- The study area is from Powers Boulevard (CO 21) to Palmer Divide Road/County Line Road, a distance of approximately 9.7 miles.

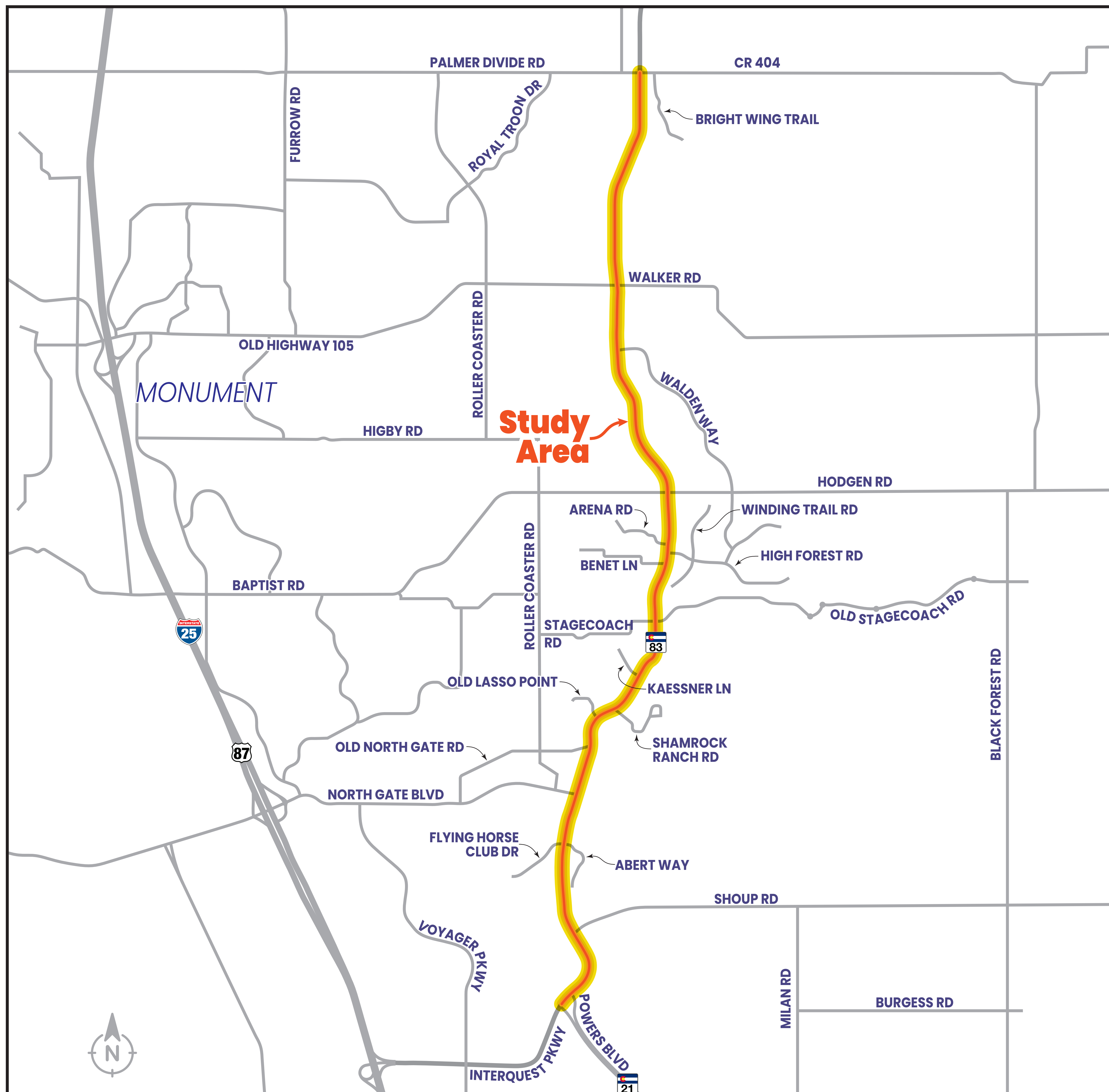

What is an Access Point?

- Any intersection or driveway along a roadway that crosses the right of way is called an access point.

ACCESS STUDY OVERVIEW

(CONTINUED)

What does an Access Study do?

- Evaluates how existing access points impact the operations and safety of vehicles, pedestrians, and bicyclists moving along and across CO 83
- Establishes a long-range vision (2045 and beyond) for access points along the highway
- Recommends future:
 - Access point locations
 - Traffic movements allowed at each access point
 - Type of intersection control (yield/stop sign or traffic signal) at each access point
- Ensures each abutting property has access either directly to CO 83 or via an adjacent local street
 - This includes identifying alternate access routes, such as future road connections or cross access opportunities between adjacent properties
- Does not determine the future number of lanes or design features of CO 83.

Why study Access Points?

- There is potential for a conflict to occur between the different modes of transportation (vehicle, pedestrian, and bicycle) at these locations.
- Vehicles turning into and out of access points can cause other vehicles to slow down, resulting in delay, congestion, or crashes.

CO 83 ACCESS STUDY OVERVIEW

(CONTINUED)

What are the goals of this Access Study?

- Identify improvements to the local transportation network that promote safety for all modes of transportation.
- Provide the appropriate level of access to properties adjacent to the highway.
- Support future development and redevelopment along CO 83.
- Provide efficient movement for all modes of transportation along and across CO 83.

Why do an Access Study on this portion of CO 83?

- Optimizing the number of access points on CO 83:
 - Reduces conflict points where a crash may occur. This is applicable not only for vehicles, but also for pedestrians and bicycles having to cross multiple access points along CO 83.
 - Creates fewer locations for vehicles to brake or turn onto or off the highway, resulting in more efficient travel for through traffic.
 - Makes the corridor more visually appealing to all users and visitors by reducing the number of driveways.

CO 83 ACCESS STUDY OVERVIEW

(CONTINUED)

Each access location is evaluated based on existing conditions, anticipated future traffic conditions, and potential for redevelopment of the adjacent parcels to make a long-range recommendation for optimizing access to CO 83.

Methods to Optimize Access

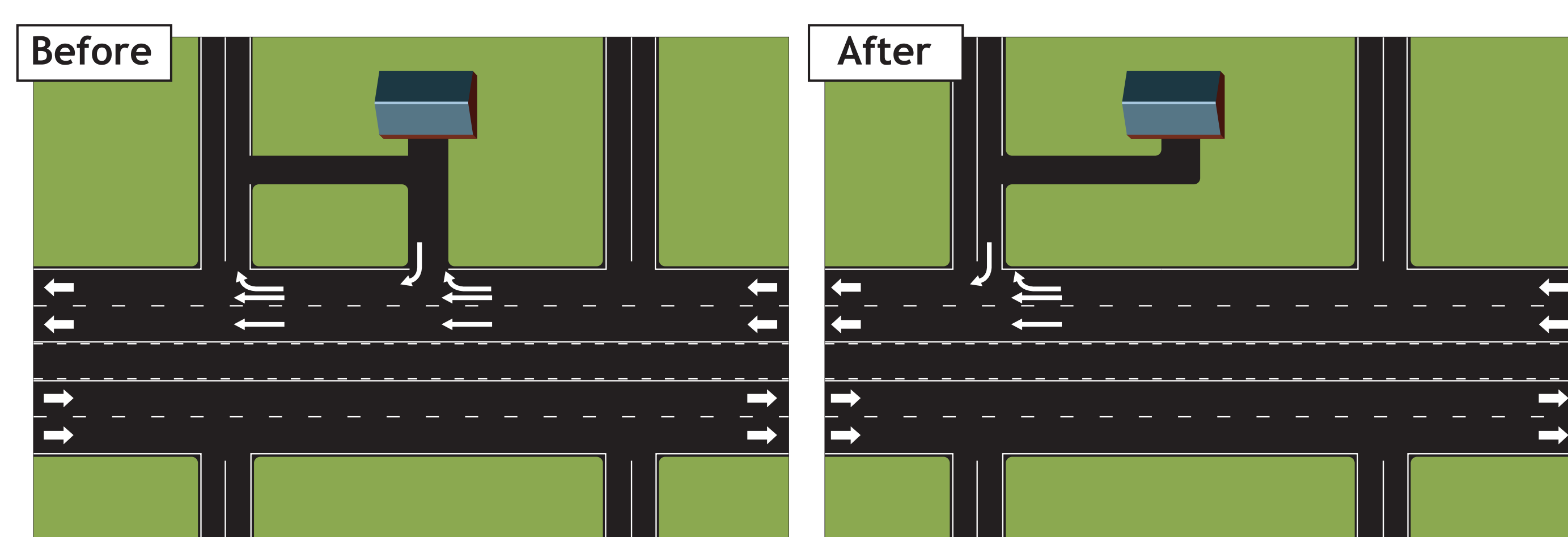

Use of Local Streets

- Provide access to local properties through secondary roads.
- Consolidate number of access locations where vehicles may enter or exit the highway.
- Reduce the number of conflict points.

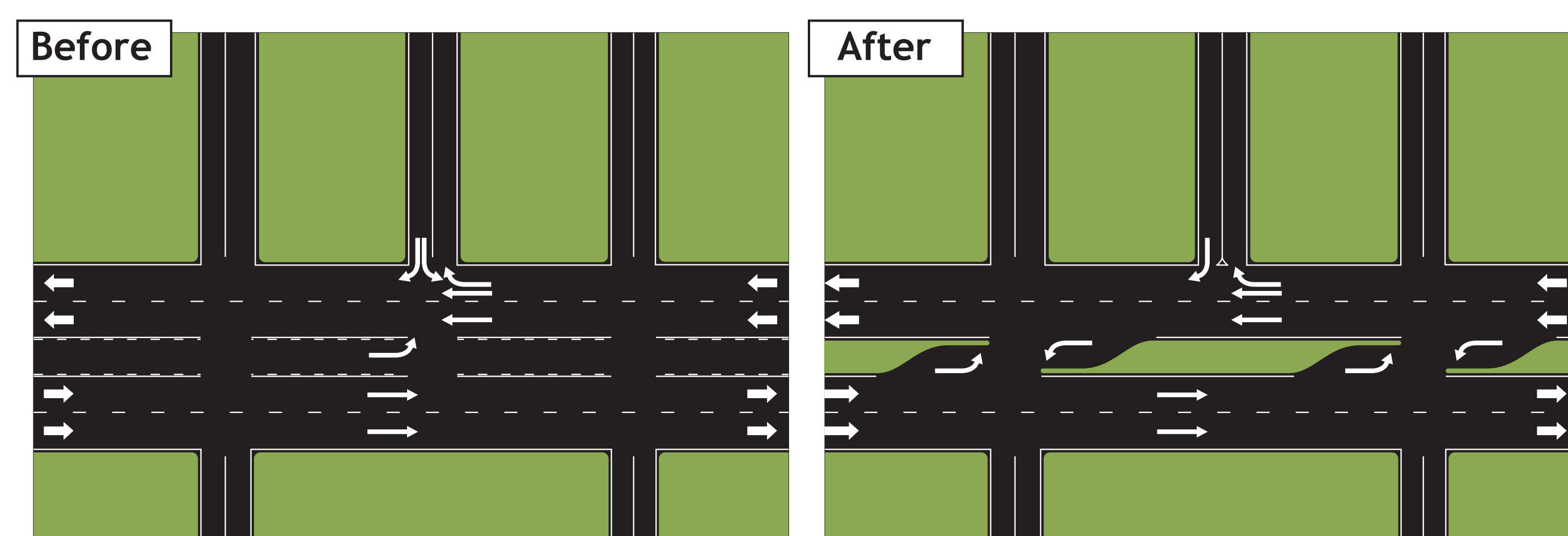

Addition of Median Treatment

- Limit turning movements to locations with a dedicated left-turn lane.
- Reduce the number of conflicts between left-turning vehicles and through vehicles on the highway.

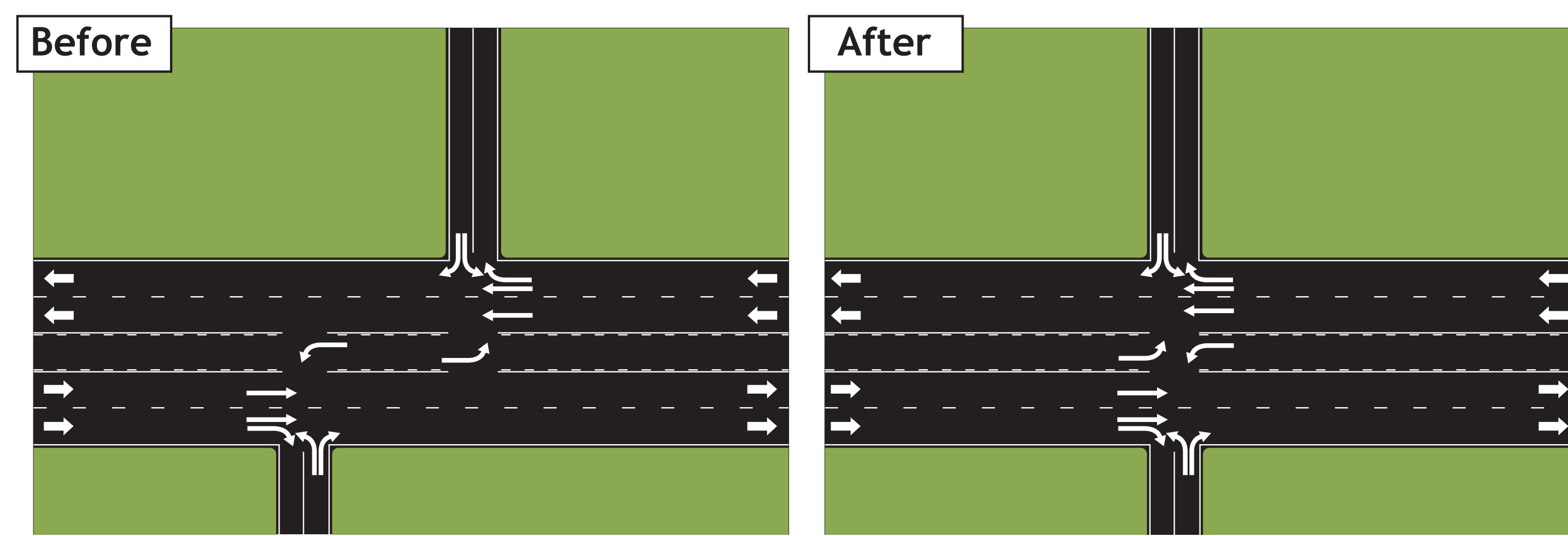

Realignment

- Align opposite approach.
- Create a more familiar intersection design.

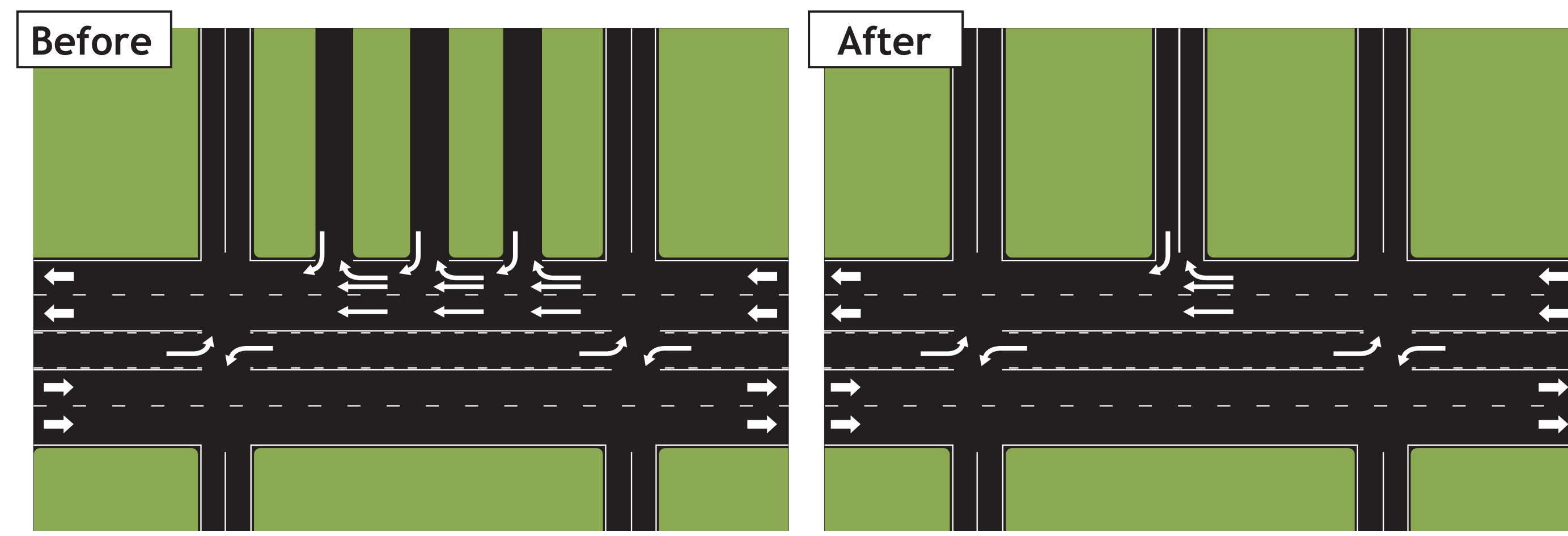

Consolidation

- Consolidate adjacent access points into fewer locations.
- Reduce the number of conflict points.

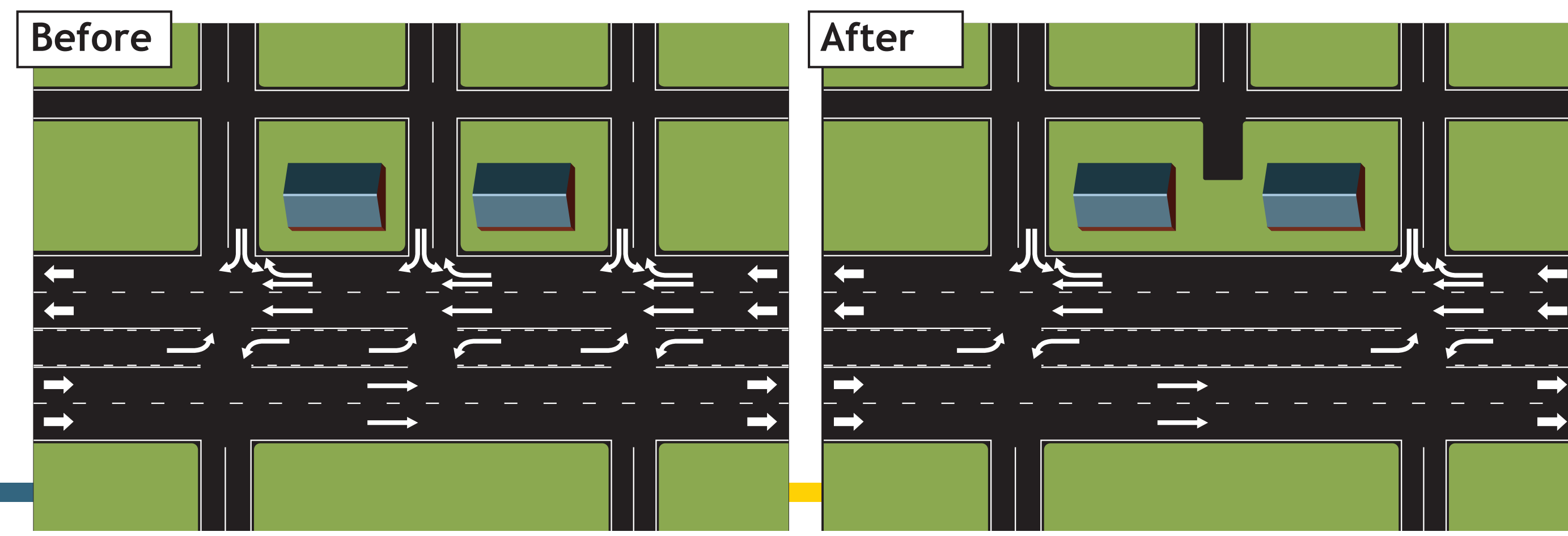

Alternate Access Route

- Provide access to properties via an improved/new alternate access road.
- Reduces the number of access points along the highway.



COLORADO

Department of Transportation

CO 83 ACCESS STUDY

ACCESS STUDY PROCESS



ACCESS STUDY PROCESS

Conduct the study

Propose improvements
based on study findings

Conduct Public Outreach

**WE
ARE
HERE**

Make Final Recommendation
based on input from public

Accept the recommendations

Prepare an Intergovernmental Agreement
between the City of Colorado Springs, El Paso County, and CDOT

Specify how the Access Study can be amended in the future,
if necessary

Sign the Intergovernmental Agreement
and adopt the recommendations

Report outcomes to the Colorado Transportation Commission
and get approval from the CDOT State Access Manager

**Continue coordination between
the City of Colorado Springs, El Paso County, and CDOT**
to ensure proper implementation of the plan in the future

ACCESS STUDY PROCESS

(CONTINUED)

When should you expect to see changes in access?

- This plan is a long-range vision (2045 and beyond) for the highway and will be implemented in phases.
- Changes to access on CO 83 will occur in phases or incrementally over time based on:
 - When a property, or series of adjacent properties, is redeveloped. The City, County, and CDOT will work with the developer to ensure the accesses are consistent with the recommendations of this study.
 - If the City, County, and/or CDOT perform a safety study (based on crash history) and identify a specific safety concern that could be improved by modifying an existing access point.
 - If the City, County, and/or CDOT complete a traffic study and identify a traffic flow and/or pedestrian/bicyclist movement that would benefit by making a change to the existing access points.
 - If the City, County, and/or CDOT identify a project, secure funding, and complete the necessary design processes to construct improvements that include modifying an existing access point.
- The City, County, and CDOT do not have any planned projects or identified funding that would close or make changes to any existing access points in the immediate future.



COLORADO

Department of Transportation

CO 83 ACCESS STUDY

EXISTING ACCESS CONDITIONS



EXISTING ACCESS CONDITIONS

SEGMENT 1: CO 83 from CO 21 (Powers Boulevard) to Old North Gate Road

- The segment is classified as an Expressway based on CDOT's State Highway Access Code.
- Expressways are intended to accommodate high traffic volumes at high travel speeds.
- Expressways prioritize movement of traffic over access to private property.
- If the property has access to a local road, direct access to the highway will be prohibited.
- Spacing between signalized full movement intersections is one mile, but half-mile spacing is acceptable if reasonable alternate access is not available.
- Existing Number and Types of Access in Segment 1:
 - Total of 12 access points in 2.75 miles
 - 3 private driveways and 9 public roads
 - All provide full-movement access and 5 intersections have traffic signals

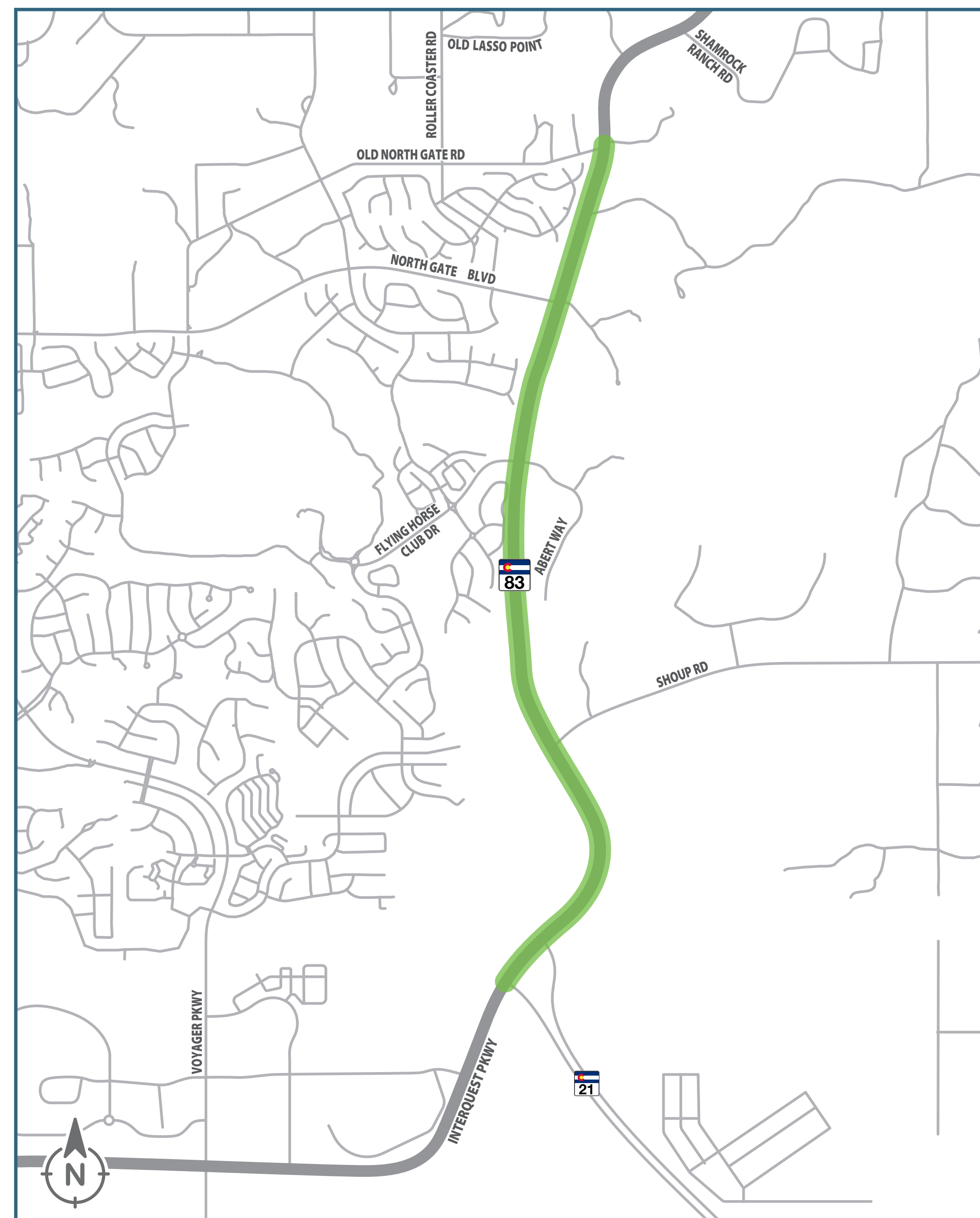

FOR MORE INFORMATION,
REFER TO THE DRAFT ACCESS STUDY RECOMMENDATIONS STATION

EXISTING ACCESS CONDITIONS

(CONTINUED)

SEGMENT 2: CO 83 from Old North Gate Road to Old Highway 105/Walker Road

- This segment is classified as a Regional Highway based on CDOT's State Highway Access Code.
- Regional Highways are intended to accommodate medium to high traffic volumes at medium to high travel speeds.
- Regional Highways are intended to provide service to through traffic movements, with lower priority on providing direct access to adjacent properties.
- Access to adjacent properties should be achieved through use of the local streets whenever reasonable.
- Spacing between signalized full movement intersections of one-half mile is preferred.
- Existing Number and Types of Access in Segment 2:
 - 47 total access points in 5 miles
 - 36 private driveways/field accesses and 11 public roads
 - 46 provide full-movement access (one is right-in only) and two intersections have traffic signals

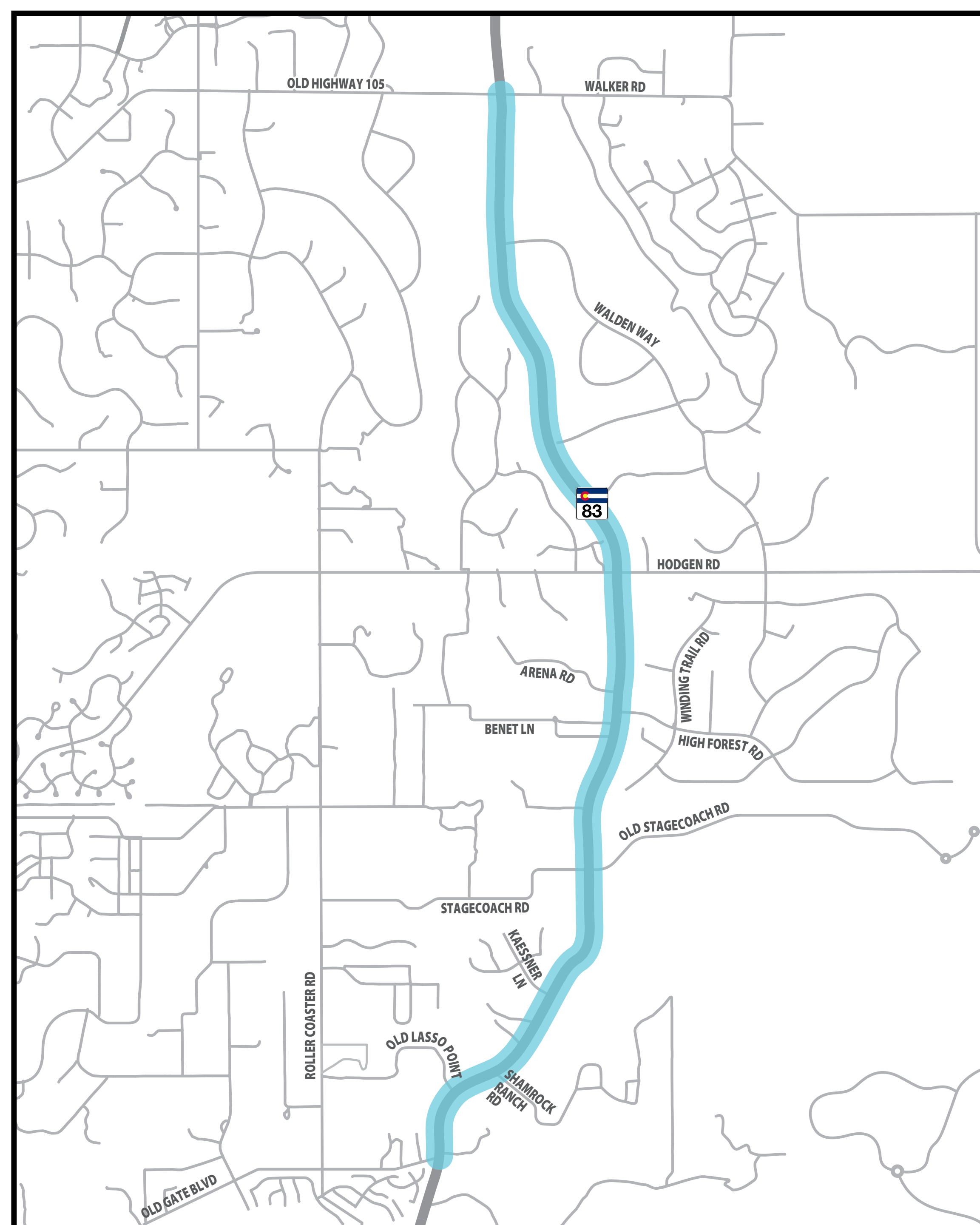

FOR MORE INFORMATION REFER
TO THE DRAFT ACCESS STUDY RECOMMENDATIONS STATION

EXISTING ACCESS CONDITIONS

(CONTINUED)

SEGMENT 3: CO 83 from Old Highway 105/Walker Road to Palmer Divide Road

- This segment is classified as a Regional Highway based on CDOT's State Highway Access Code.
- Regional Highways are intended to accommodate medium to high traffic volumes at medium to high travel speeds.
- Regional Highways are intended to provide service to through traffic movements, with lower priority on providing direct access to adjacent properties.
- Access to adjacent properties should be achieved through use of the local streets whenever reasonable.
- Spacing between signalized full movement intersections of one-half mile is preferred.
- Existing Number and Types of Access in Segment 3:
 - 13 total access points in 2.1 miles
 - 11 private driveways/field accesses and 2 public roads
 - All provide full-movement access and 1 intersection has a traffic signal

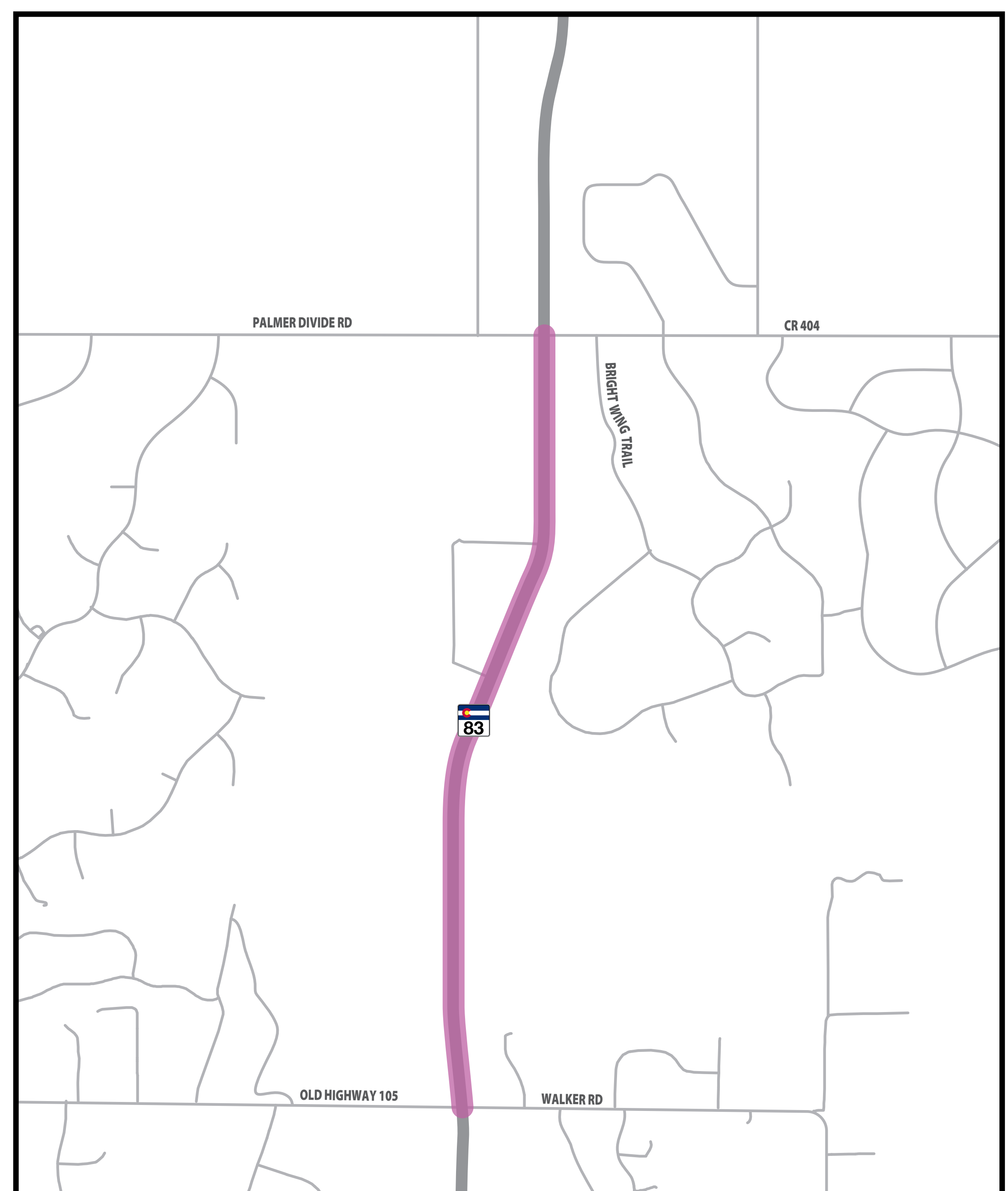

FOR MORE INFORMATION REFER
TO THE DRAFT ACCESS STUDY RECOMMENDATIONS STATION



COLORADO

Department of Transportation

CO 83 ACCESS STUDY

EXISTING SAFETY CONDITIONS



EXISTING SAFETY CONDITIONS

Crashes occur at conflict points, which are locations where two movements (vehicles, pedestrians, or bicyclists) cross paths.

Conflict Points by Access Type

Full Movement Access

- 4 Crossing
- 12 Turning
- 8 Merge/Diverge
- 8 Pedestrian

- 32 Total**

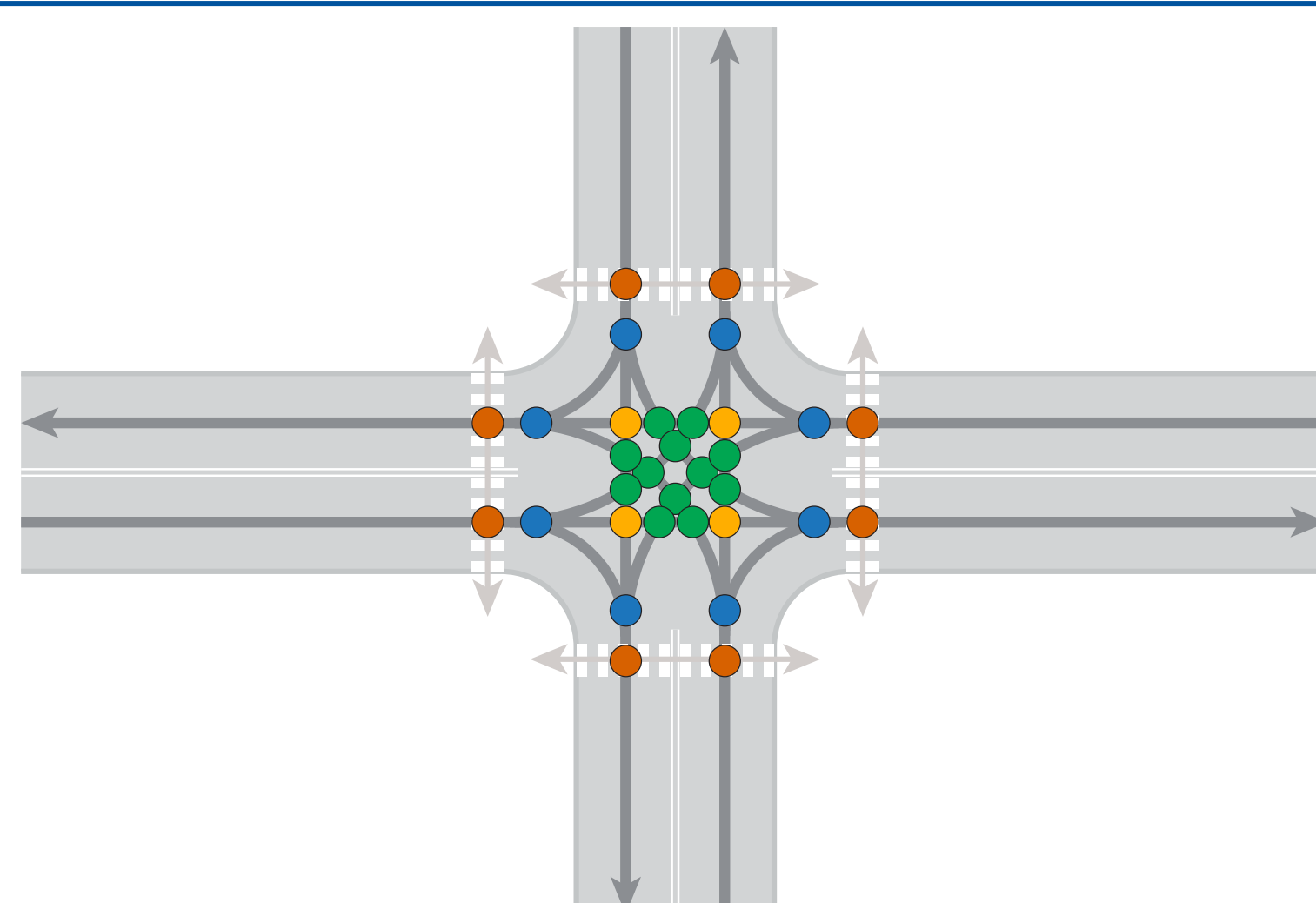

- All movements in all directions are allowed
- May include the need for a traffic signal

3/4 Movement Access

- 0 Crossing
- 2 Turning
- 8 Merge/Diverge
- 4 Pedestrian

- 14 Total**

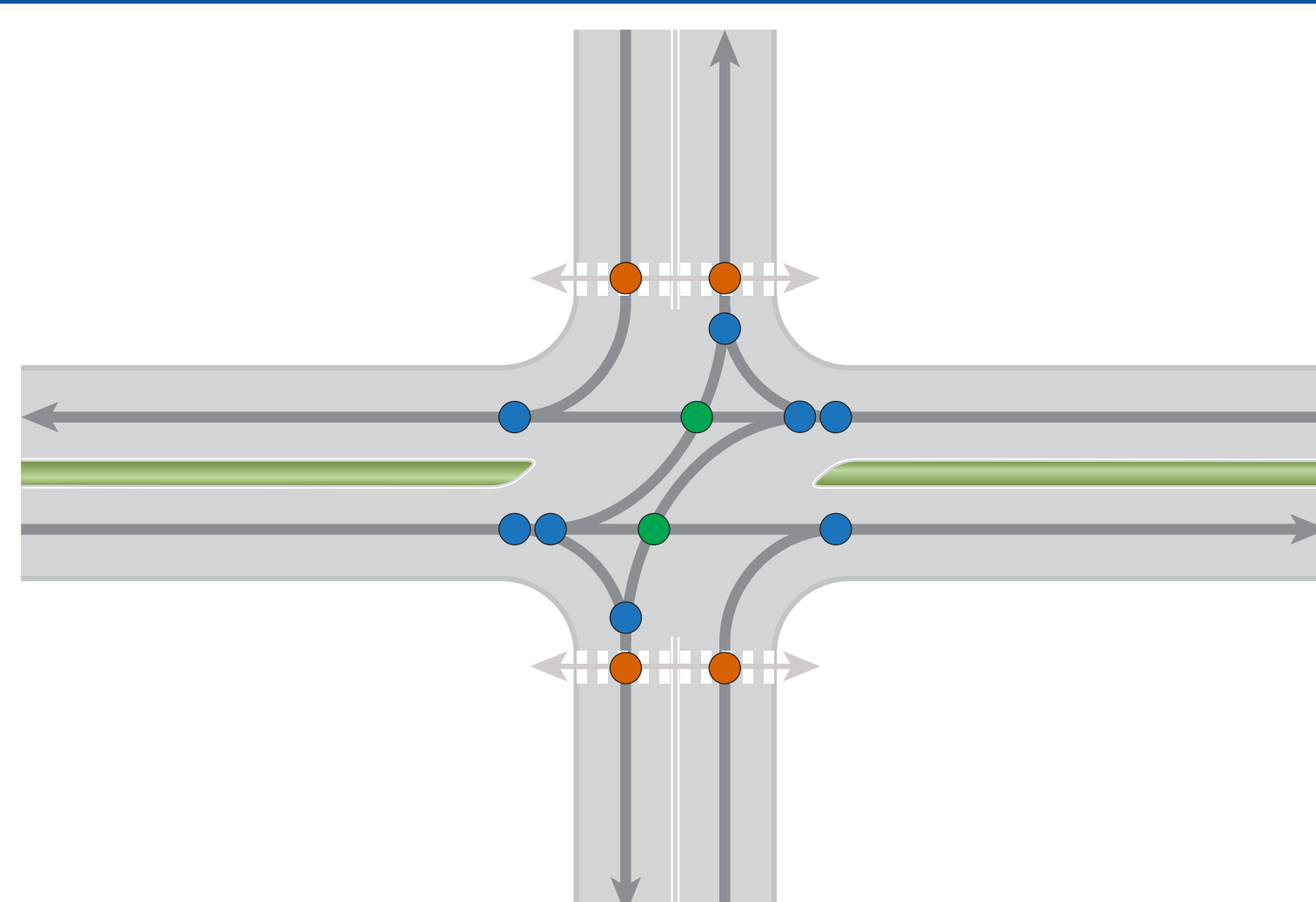

- Right-in, right-out and left-in are allowed
- Traffic median prevents left-out and straight movements—these movements must be completed at another intersection

Right-in/Right-out Access

- 0 Crossing
- 0 Turning
- 4 Merge/Diverge
- 4 Pedestrian

- 8 Total**

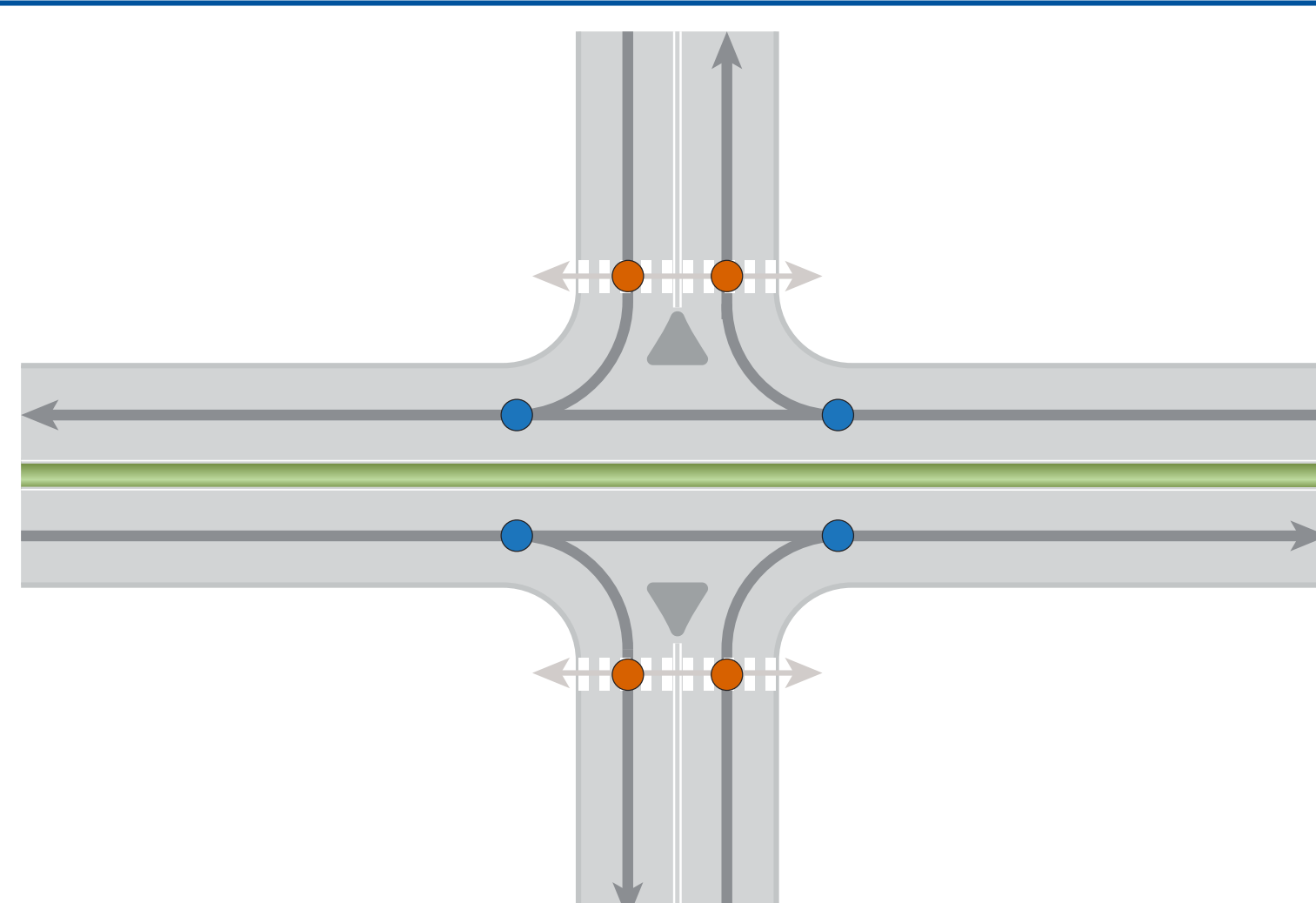

- Only right turns are allowed
- Traffic median prevents left turns and straight movements—these movements must be completed at another intersection

Roundabout

- 4 Crossing
- 0 Turning
- 16 Merge/Diverge
- 8 Pedestrian

- 28 Total**

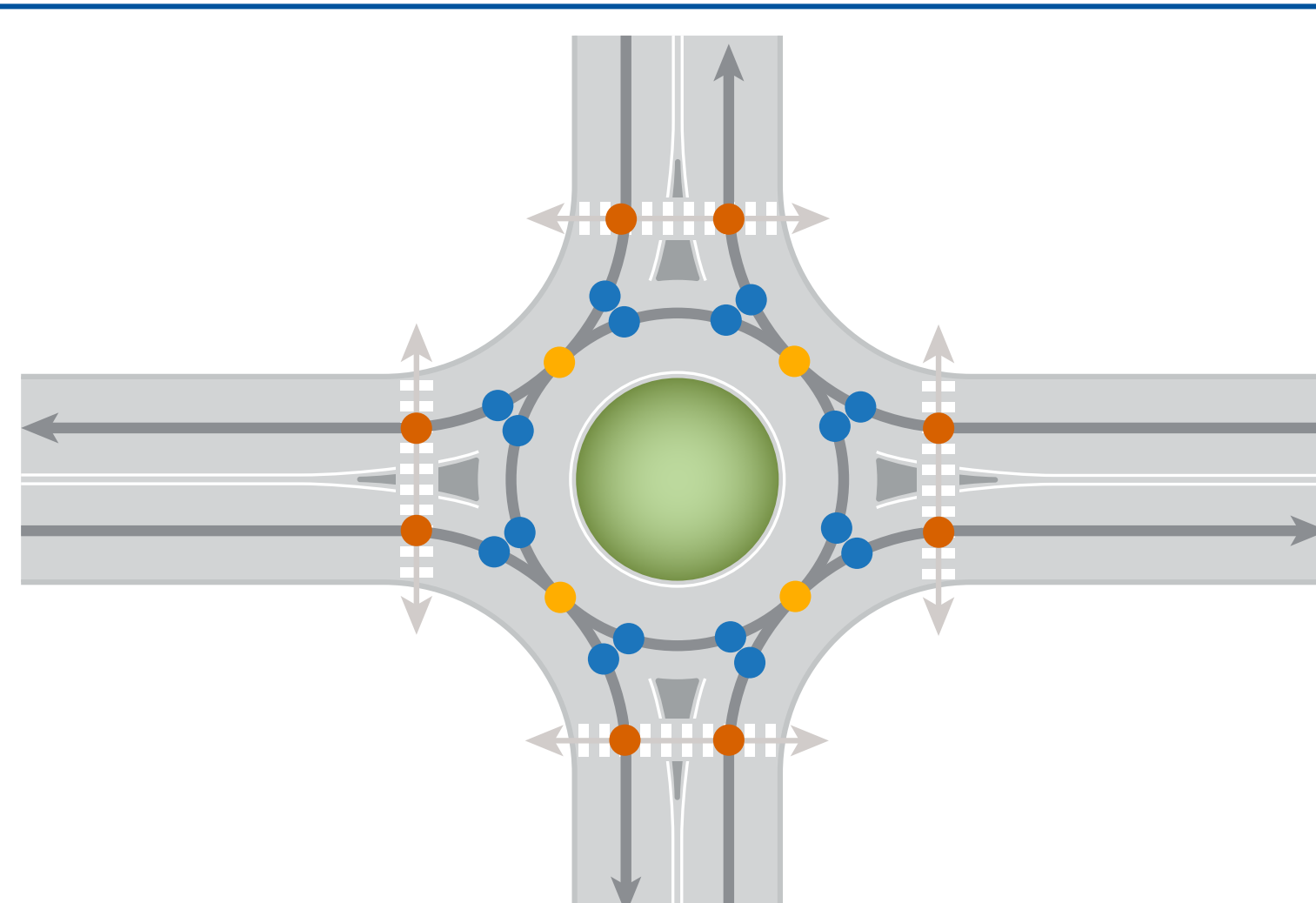

- All movements, including u-turns, are allowed at a circular intersection
- Raised circular median and signing directs drivers to travel in a counterclockwise movement through the intersection

Access studies identify ways to minimize conflict points in an effort to reduce crashes, improve traffic flow, and maintain appropriate access to adjacent properties.

EXISTING SAFETY CONDITIONS

(CONTINUED)

CDOT maintains a crash data base for all reported crashes that occur along a highway.

The safety performance of a highway is based on roadway characteristics, such as the number of lanes and the volume of traffic.

Highway safety performance is evaluated for crashes that occur at intersections and those that occur along segments in-between intersections (non-intersection).

Each intersection and segment of a highway then is evaluated to measure safety based on the expected safety for the given roadway characteristics. The result is called Level of Service of Safety or LOSS.

LOSS indicates the ability to reduce crashes by making changes to the design of an access or to the roadway.

LOSS is defined as follows:

- **LOSS I** indicates a low potential for crash reduction
- **LOSS II** indicates a low to moderate potential for crash reduction
- **LOSS III** indicates a moderate to high potential for crash reduction
- **LOSS IV** indicates a high potential for crash reduction

LOSS does not identify the nature of the safety problem, but a higher LOSS score helps to identify locations where additional analysis is needed.

An analysis of crash patterns is used to determine the nature of the safety problem and make recommendations to reduce crash potential at intersections or on highway segments.

EXISTING ACCESS CONDITIONS

Segment 1

Non-Intersection Related Crash Summary

(CDOT crash data from 12/31/14 to 12/31/19)

Intersection Related Crash Summary

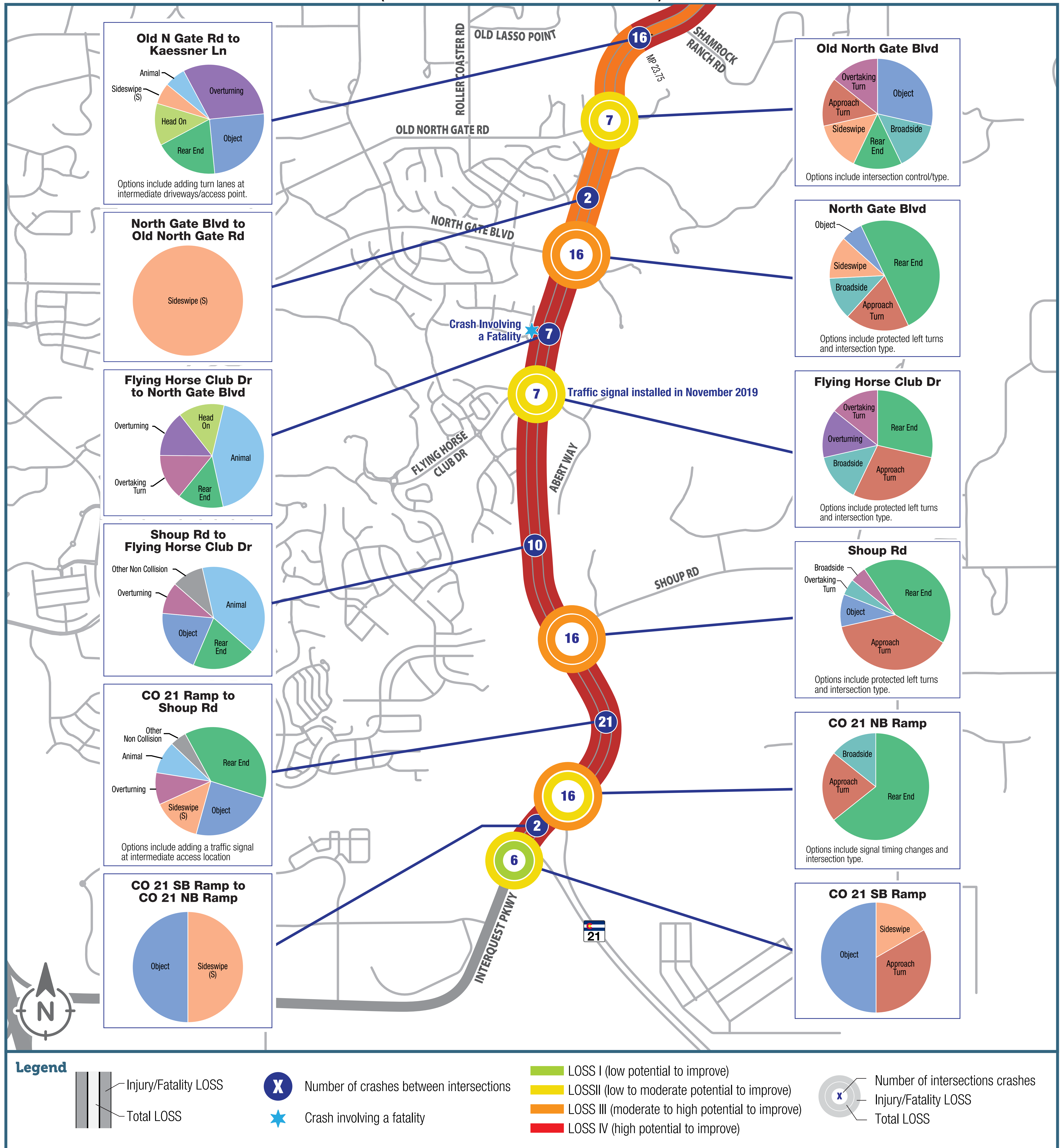

EXISTING ACCESS CONDITIONS

Segment 2

Non-Intersection Related Crash Summary

(CDOT crash data from 12/31/14 to 12/31/19)

Intersection Related Crash Summary

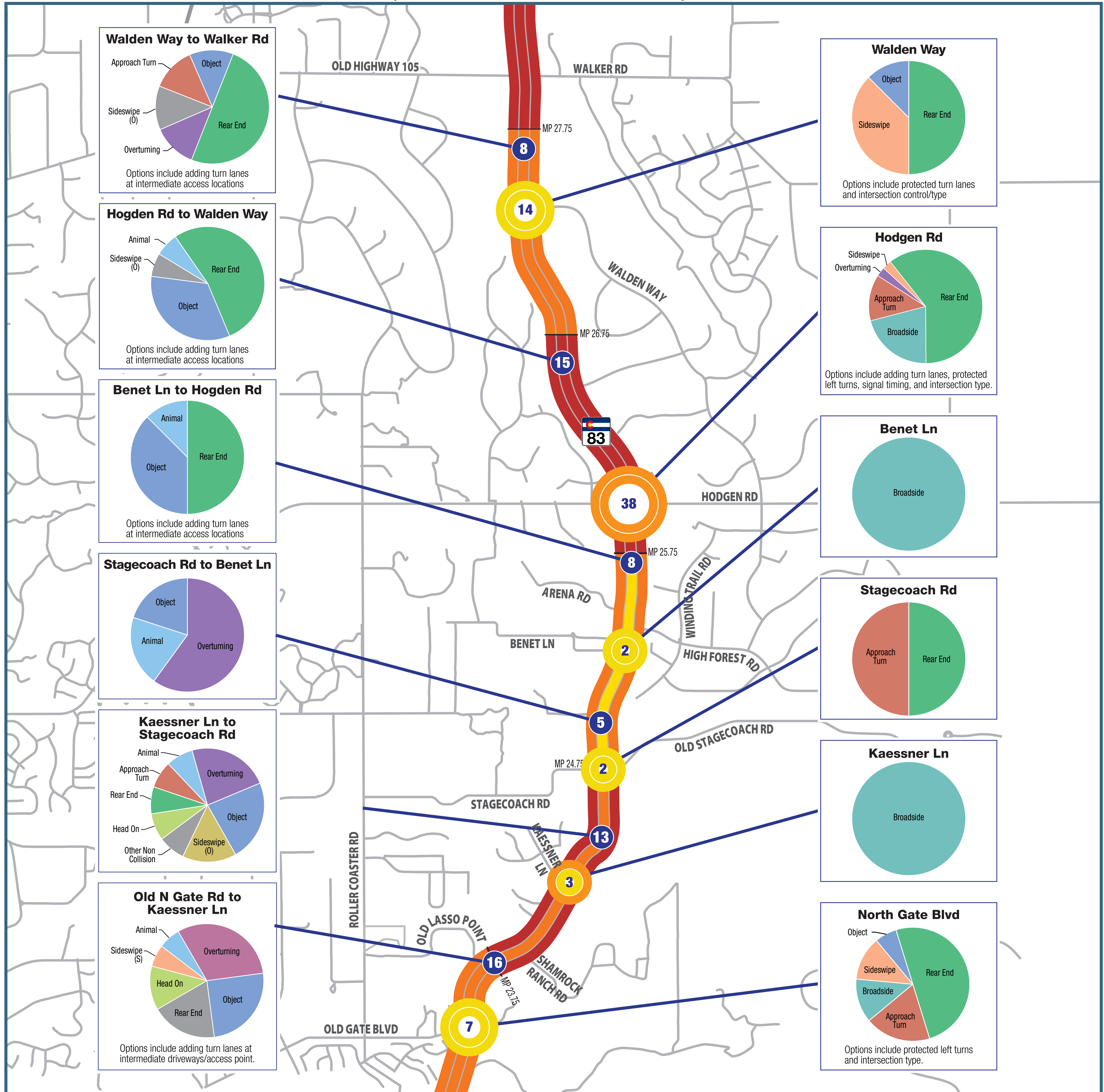

Legend

- Injury/Fatality LOSS
- Total LOSS
- Number of crashes between intersections
- Crash involving a fatality
- LOSS I (low potential to improve)
- LOSS II (low to moderate potential to improve)
- LOSS III (moderate to high potential to improve)
- LOSS IV (high potential to improve)
- Number of intersections crashes
- Injury/Fatality LOSS
- Total LOSS

EXISTING ACCESS CONDITIONS

Segment 3

Non-Intersection Related Crash Summary

(CDOT crash data from 12/31/14 to 12/31/19)

Intersection Related Crash Summary

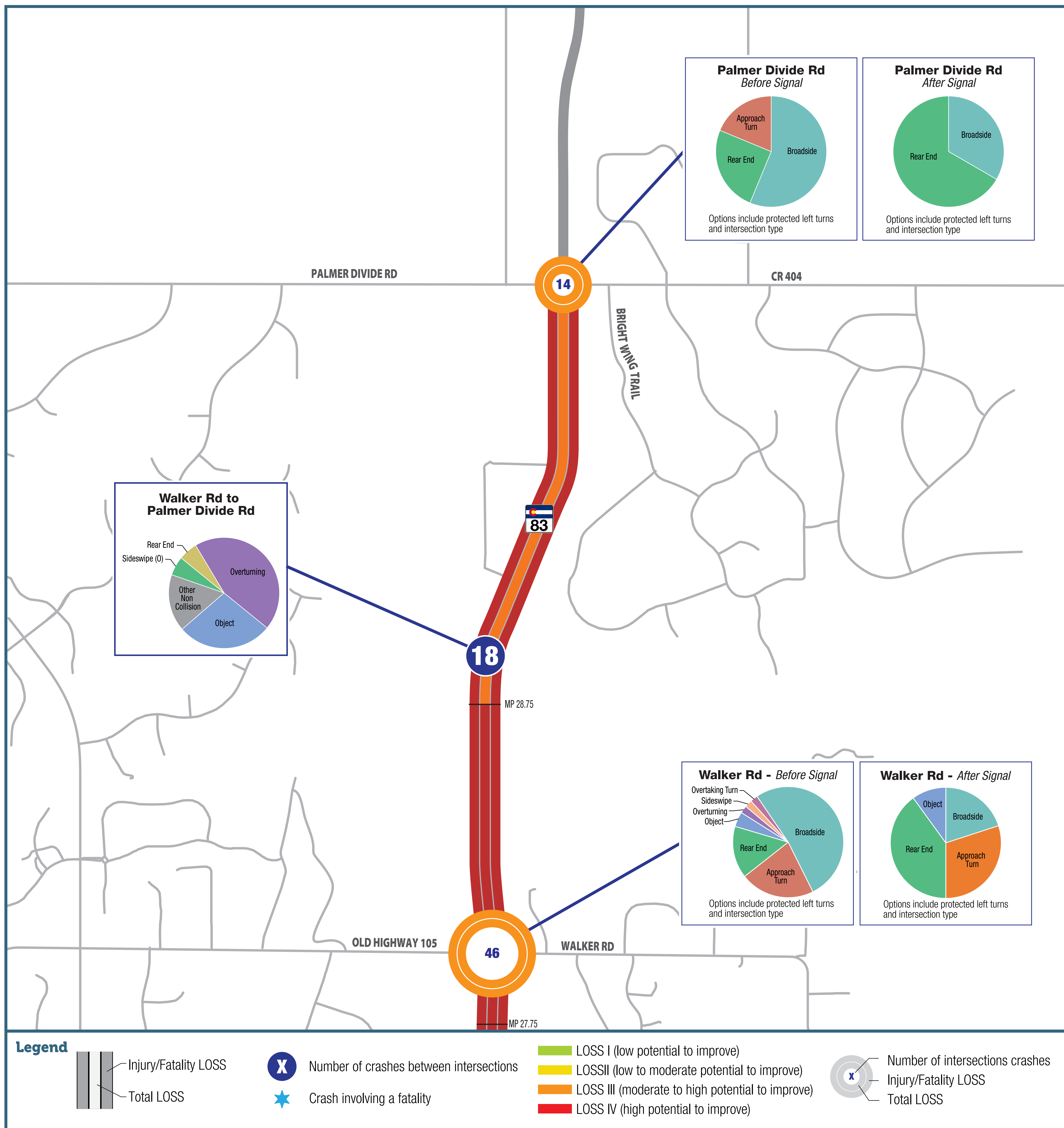

EXISTING SAFETY CONDITIONS

(CONTINUED)

CO 83 crash summary and observed patterns

- **Crash involving two vehicles on CO 83**
 - **Typical types of crashes:** rear end, side-swipe, and left turn
 - **Possible solutions:** reducing turn movements or using protected green arrows at traffic signals
- **Crash involving one vehicle on CO 83 and one vehicle on a side street**
 - **Typical types of crashes:** broadside and left turn
 - **Possible solutions:** reducing turn movements or constructing traffic signals or other intersection improvements
- **Crash involving two vehicles at a location between intersections on CO 83**
 - **Typical types of crashes:** rear end, broadside, and side-swipe
 - **Possible solutions:** reducing turn movements, increasing spacing between driveways, restricting driveway access near intersections, or adding turn lanes at access locations
- **There were no reported crashes involving pedestrians or bicyclists on CO 83**

CO 83 Overall Crash Summary (MP 20.37 to 30.24)

	Rear-End	Broadside	Object	Approach Turn	Overtaking	Sideswipe (same)	Animal	Other Non Collision	Overtaking Turn	Sideswipe (opposite)	Head-On	Total
Number	116	50	44	41	28	18	15	6	6	5	4	333
Percent	35%	15%	13%	12%	8%	5%	5%	2%	2%	2%	1%	—

Source: CDOT DiExSys™ (12/31/14 - 12/31/19)

DRAFT ACCESS STUDY RECOMMENDATIONS

SEGMENT 1: CO 21 to Old North Gate Road

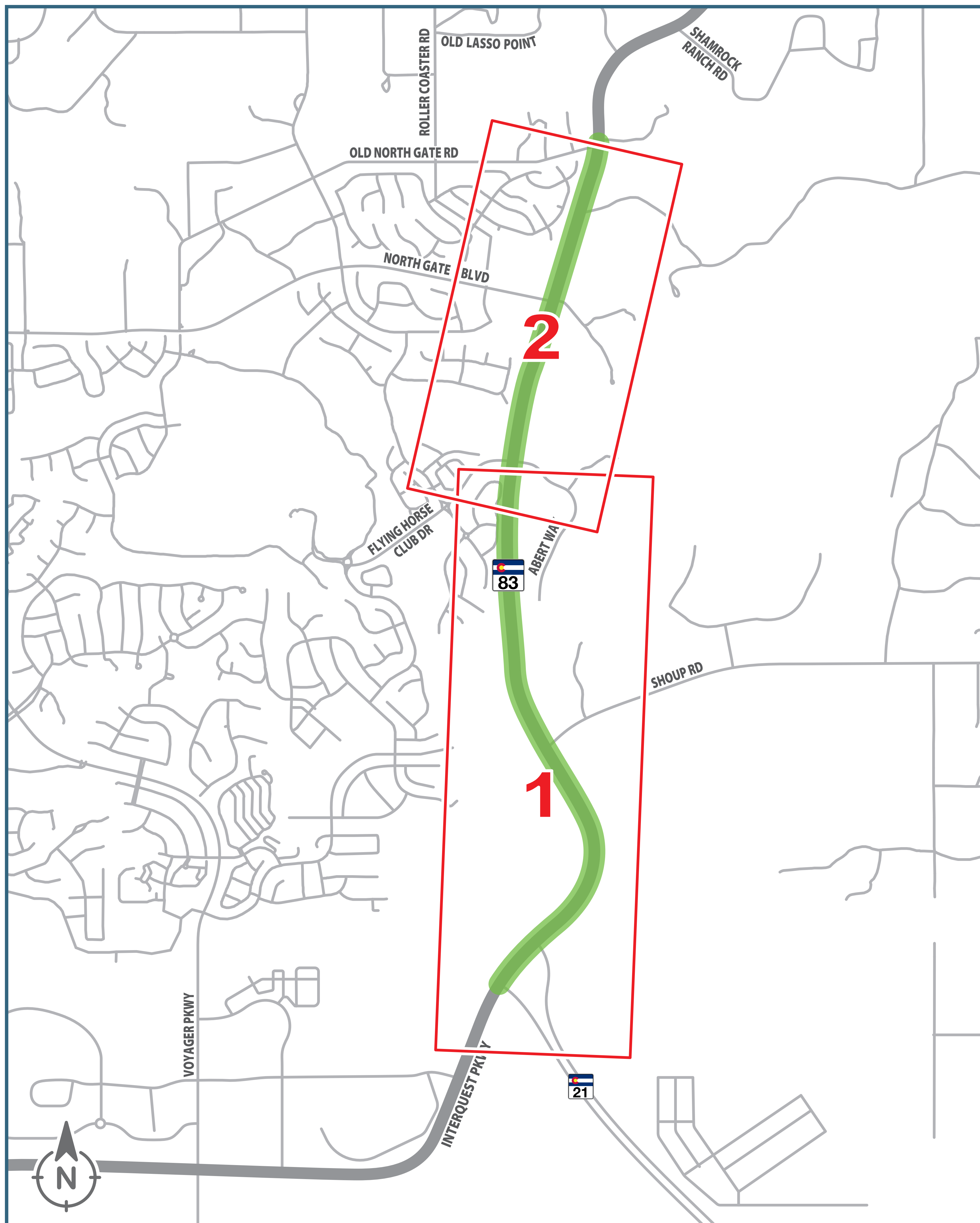

[CLICK FOR A MAP OF ALL SEGMENT 1 RECOMMENDATIONS](#)

DRAFT ACCESS STUDY RECOMMENDATIONS

SEGMENT 2: Old North Gate Road to Walker Road

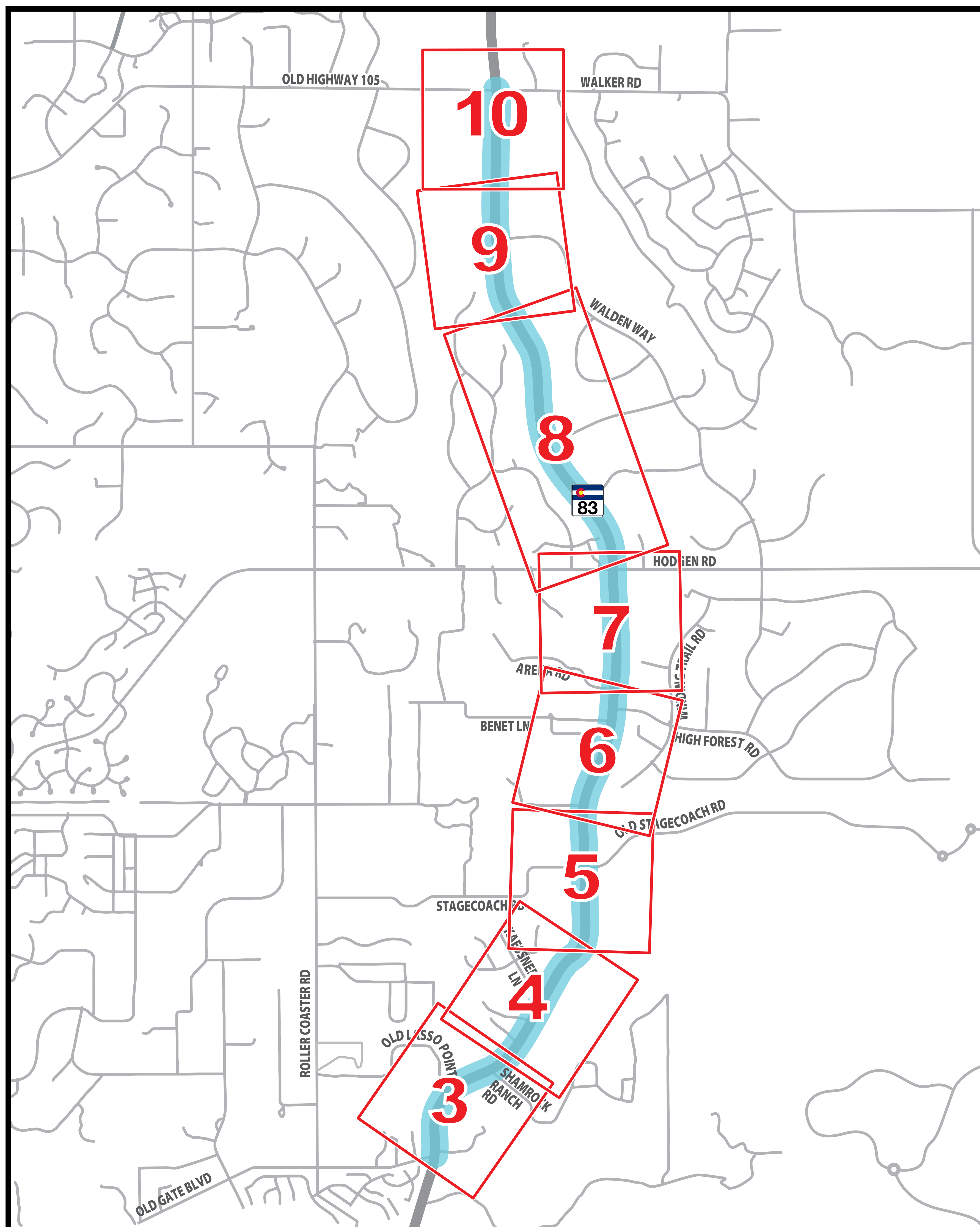

 [CLICK FOR A MAP OF ALL SEGMENT 2 RECOMMENDATIONS](#)

DRAFT ACCESS STUDY RECOMMENDATIONS

SEGMENT 3: Walker Road to Palmer Divide Road

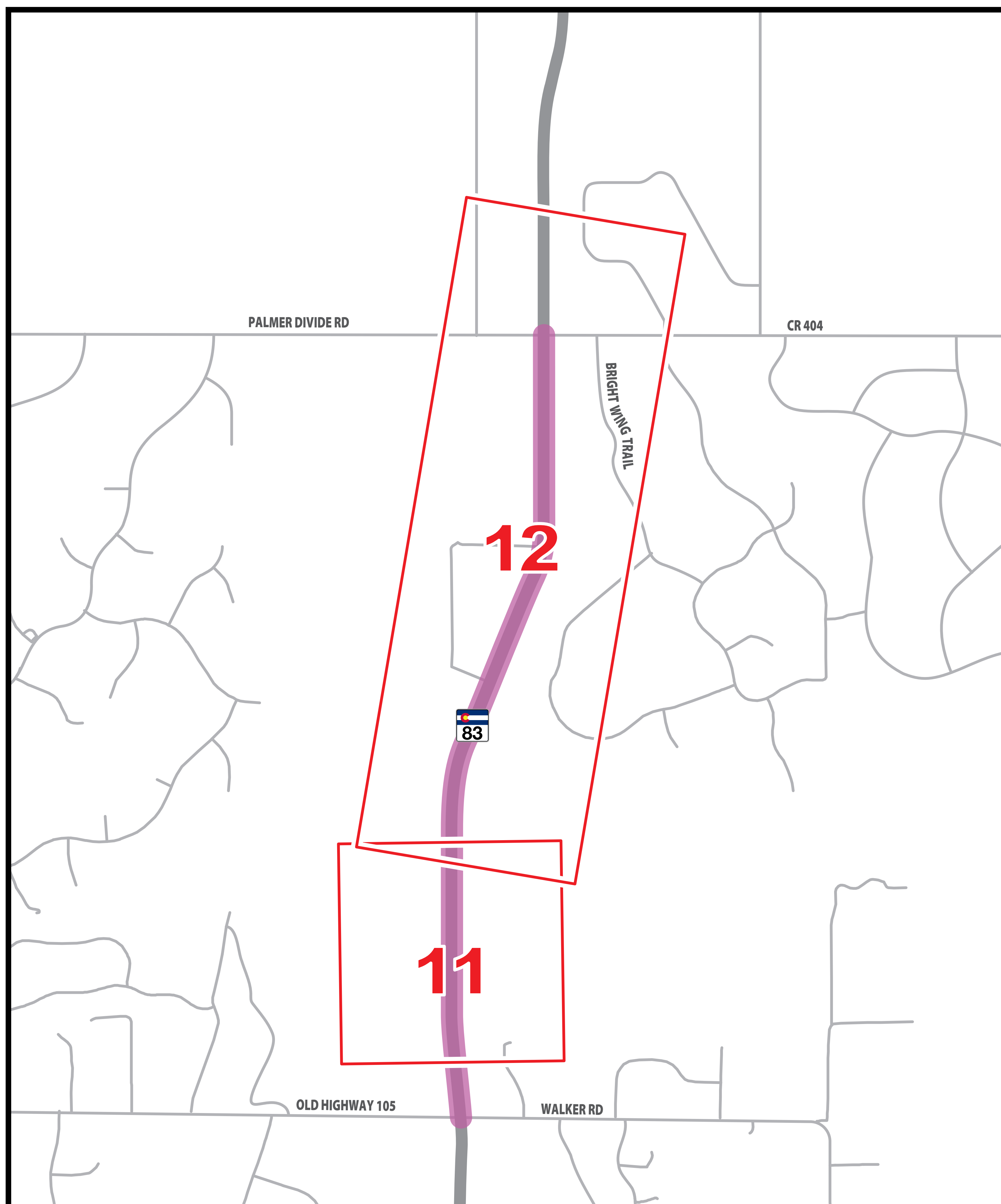

 [CLICK FOR A MAP OF ALL SEGMENT 3 RECOMMENDATIONS](#)



COLORADO

Department of Transportation

CO 83 ACCESS STUDY



CLOSING



CLOSING

How will the recommended changes in access benefit CO 83 users?

Enhance Safety

- A reduction in the number of conflict points reduces the potential for crashes.

Provide Access to Adjacent Properties

- All properties will have access to CO 83 or the local streets.

Support Future Development/Redevelopment

- Better access improves visual appeal of the highway to help attract development and visitors.

Increase Efficient Movement

- Fewer access points reduces congestion caused by vehicles turning onto and off of CO 83.

CLOSING

(CONTINUED)

THANK YOU FOR ATTENDING THE OPEN HOUSE!

Your participation is appreciated.
Please take a moment to:

- Complete a comment form.

 A dark blue button with white text that reads "CLICK HERE FOR COMMENT FORM". On the left side of the button, there is a white cursor icon pointing towards the top-left corner.

- Plan to attend the next public meeting (April/May 2021).
- Request a member of our study team contact you if you have additional concerns.
- Contact the study team:

Valerie Vigil, CDOT Permits Manager, at
Valerie.Vigil@state.co.us

Dave Sprague, Consultant Project Manager, at
david.sprague@atkinsglobal.com



COLORADO
Department of Transportation

E.2. Public Comment Responses

The following are responses sent via email to individuals that provided comments at the first Highway 83 Access Study virtual meeting and the project team determined that an email response was appropriate with no additional follow up.

Dear Anthony Mudford,

The City of Colorado Springs, El Paso County (County), and the Colorado Department of Transportation (CDOT), would like to thank you for taking the time to participate in the Highway 83 Access Study virtual Open House that recently concluded in March of 2021. We appreciate the time you took to provide feedback and comments on the study. We assure you that we are considering your thoughts and making necessary adjustments to the study's recommendations in order to improve access, mobility, and safety for all users of Highway 83.

This study is a long-term plan. The majority of the recommendations that we have shown will not happen unless there's redevelopment of a property, major changes to the highway, or if multiple property owners and the County decide that they want to work together to create an alternative access—such as creating access to a future signal. Thus, if a property does not redevelop (significant change in land use) it will continue to have access to the highway, although it may be restricted to something less than full movement in the future. Also, as traffic increases or a highway improvement project adds lanes, this plan provides guidance on where future traffic signals may be located. In addition, the plan provides opportunities for the creation of alternative access so that most adjacent properties would have direct access to Highway 83 at a signalized location, which will improve safety.

You provided the following comments/questions about the study:

- There have been many accidents at the corner of Kaessner Lane and Highway 83 with people traveling north and then turning left onto Kaessner Lane. We need a passing lane to ensure the safety of people turning left, also a merging lane when turning right onto Highway 83 from Kaessner Lane.

In response to your comment: The purpose of the access study is to determine the location and type of access that will be allowed along Highway 83. This study does not make recommendations regarding design elements of an access point, such as turn lanes. The decision to add a left turn lane or right turn acceleration lane to Highway 83 at Kaessner Lane would be considered in a separate study conducted by the CDOT and/or the County or through major redevelopment of a property/properties. According to the State of Colorado State Highway Access Code and the Access Category of SH 83 in this area, a left turn lane is not required at an access point unless there are at least 10 vehicles making the left turn during a single hour. A right turn acceleration lane is not required until there are 50 vehicles per hour making the right turn. Traffic counts completed as part of this study show left turn volumes and right turn volumes at Kaessner Lane are less than 5 vehicles per hour, thus the traffic volume does not currently warrant the addition of a left turn or right turn acceleration lane. However, the recommendations from this study do not preclude such an addition should a future study show a need.

It should be noted the ultimate plan for Highway 83 recommends closing Kaessner Lane to allow for better spacing between major access location, provide for opportunities to consolidate access points, and improves access design by allowing for the development of turn lanes at more access locations. This closure would only occur if alternative access, such as an extension of Outlook Drive just to the north, which would provide access to Highway 83. However, if Outlook Drive is not extended to intersect with Highway 83 then Kaessner Lane would remain open. In addition, should Highway 83 be improved, which may include the expansion to four lanes, it is possible that turn lanes could be added to Highway 83 at Kaessner Lane or other access locations within the study area. Finally, Kaessner Lane may not remain full

movement. Should a traffic study, to be conducted by CDOT or the County, was to show an operational or safety issue at Kaessner Lane, or if the adjacent properties were to redevelop, then Kaessner Lane may be restricted to less than full movement (right-in, right-out or three quarter movement).

In summary:

- This study does not make recommendations regarding design elements of an access points, such as turn lanes.
- Traffic counts completed as part of this study show left turn volumes and right turn volumes at Kaessner Lane are less than 5 vehicles per hour, thus the traffic volume does not warrant the addition of a left turn or right turn acceleration lane.
- The ultimate recommendation is for Outlook Drive to be extended to intersection with Highway 83, which would allow for the closure of Kaessner Lane.
- If Kaessner Lane remains open, it is possible that turn lanes would be added as part of a future highway improvement project, such as widening the highway to four lanes.
- If an operational or safety issue is identified at Kaessner Lane, or if the adjacent properties were to redevelop, then Kaessner Lane may be restricted to less than full movement (such as right-in, right-out or three-quarter movement).

We would encourage you to watch for announcements about possible additional meetings in the near future and invite you to continue to participate in shaping the final outcomes of the Highway 83 Access Study.

Thanks again for your participation and comments. If you require additional communication from the project team, please do not hesitate to contact one of us.

Very Respectfully,

Valerie Vigil
Colorado Department of Transportation, Permits Manager
Valerie.Vigil@state.co.us

Victoria Chavez
El Paso County, Principal Transportation Planner
VictoriaChavez@elspasoco.com

Jennifer Irvine
El Paso County, County Engineer
JenniferIrvine@elspasoco.com

David Sprague, PE
Consultant Project Manager
David.Sprague@atkinsglobal.com

ThCO 83 Access Control Plan Stakeholder Responses

Category 1: No specific comment on access.

Dear XXXXXX,

The City of Colorado Springs, El Paso County, and the Colorado Department of Transportation would like to thank you for taking the time to participate in the Highway 83 Access Study virtual meeting that recently concluded in March of 2021. We appreciate the time you took to provide feedback and comments on the study. We assure you that we are considering your thoughts and making necessary adjustments to the study's recommendations to improve access, mobility, and safety for all users of Highway 83. We would encourage you to watch for announcements about possible additional meetings in the near future and invite you to continue to participate in shaping the final outcomes of the Highway 83 Access Study.

Thanks again for your participation and comments. If you have additional questions or comments for the project team, please do not hesitate to contact me.

Valerie Vigil

Victoria Chavez

Jenifer Sullivan

CDOT, Permits Manager
County Engineer

El Paso County, Principal Transportation Planner

El Paso County,

Valerie.Vigil@state.co.us

VictoriaChavez@elpasoco.com

JeniferSullivan@elpasoco.com

David Sprague, PE

Consultant Project Manager

David.Sprague@atkinsglobal.com

CO 83 ACP Stakeholder Responses

Category 2: Try email first and then do phone call if still needed.

Dear Dave Kristick,

The City of Colorado Springs, El Paso County (County), and the Colorado Department of Transportation (CDOT), would like to thank you for taking the time to participate in the Highway 83 Access Study virtual Open House that recently concluded in March of 2021. We appreciate the time you took to provide feedback and comments on the study. We assure you that we are considering your thoughts and making necessary adjustments to the study's recommendations in order to improve access, mobility, and safety for all users of Highway 83.

This study is a long-term plan. The majority of the recommendations that we have shown will not happen unless there's redevelopment of a property, major changes to the highway, or if multiple property owners and the County decide that they want to work together to create an alternative access—such as creating access to a future signal. Thus, if a property does not redevelop (significant change in land use) it will continue to have access to the highway, although it may be restricted to something less than full movement in the future. Also, as traffic increases or a highway improvement project adds lanes, this plan provides guidance on where future traffic signals may be located. In addition, the plan provides opportunities for the creation of alternative access so that most adjacent properties would have direct access to Highway 83 at a signalized location, which will improve safety.

You provided the following comments/questions about the study:

- I was reading my Sunday Gazette and noticed the ad for the SH83 Access Study Open House. Having driven SH83 almost weekly for over 20+ years, having boarded and trained horses in Castle Rock, Parker, and Elizabeth, I've experienced so many traffic mishaps on SH83 – fortunately never having been involved in one. I wanted to thank you for conducting this access study, if not for safety reasons alone. I was curious though – I noted there was not any mention of the I-25/Powers Blvd (Voyager Parkway) project influence on the access study, particularly in the most southern portion of the access study area – let alone how CDOT plans to design the future connection between Powers@Interquest and the under construction I-25/Powers/Voyager interchange – that connect looks terribly challenging? Were grade separations (north/south on SH83) considered (future)?

In response to your comment: The purpose of the access study is to determine where access should be allowed on Highway 83. The Powers Boulevard extension to I-25 is a planned improvement in the future but is outside the scope of this project. The access study has identified and preserved the access locations to allow Powers Boulevard to connect to Highway 83 should the roadway be extended to I-25. These accesses are shown as Accesses 1 and 73 (future Powers Boulevard southbound off and on-ramps) and Accesses 2 and 74 (future Powers Boulevard northbound off and on-ramps). It is beyond the scope of this study to make the recommendation for Powers Boulevard to be extended, but the study has provided recommendations that would allow access between Highway 83 and Powers Boulevard should the extension occur in the future.

The future extension of Powers Boulevard would have some impact on Highway 83, primarily in the level of traffic that would use Highway 83 versus using the new extension of Powers. However, the extension of Powers Boulevard would not have an impact on the recommendations shown in the access study.

Your thoughts about considering grade separations or interchanges along Highway 83 at the major crossroads was given consideration as we developed our recommendations. While our recommendations do not include specific locations for interchanges, the goal of our study is not to preclude such improvements from occurring in the future. However, before building such a large infrastructure improvement, the CDOT and the County would work together to complete a detailed study of the environmental impacts, needed right-of-way, drainage improvements, costs to construct/maintain, and other factors to determine if an interchange would be desirable at any intersection along Highway 83.

In summary:

- The Colorado Department of Transportation (CDOT) and the County would work together to complete a detailed study of the environmental impacts, needed right-of-way, drainage improvements, costs to construct/maintain, and other factors to determine if an interchange would be desirable at any intersection along Highway 83.
- It is beyond the scope of this study to make the recommendation for Powers Boulevard to be extended, but the study has provided recommendations that would allow access between Highway 83 and Powers Boulevard should the extension occur in the future.

We would encourage you to watch for announcements about possible additional meetings in the near future and invite you to continue to participate in shaping the final outcomes of the Highway 83 Access Study.

Thanks again for your participation and comments. If you require additional communication from the project team, please do not hesitate to contact one of us.

Very Respectfully,

Valerie Vigil
Colorado Department of Transportation, Permits Manager
Valerie.Vigil@state.co.us

Victoria Chavez
El Paso County, Principal Transportation Planner
VictoriaChavez@elpasoco.com

Jennifer Irvine
El Paso County, County Engineer
JenniferIrvine@elpasoco.com

David Sprague, PE
Consultant Project Manager
David.Sprague@atkinsglobal.com

CO 83 ACP Stakeholder Responses

Category 2: Try email first and then do phone call if still needed.

Dear Dave Munns,

The City of Colorado Springs, El Paso County (County), and the Colorado Department of Transportation (CDOT), would like to thank you for taking the time to participate in the Highway 83 Access Study virtual Open House that recently concluded in March of 2021. We appreciate the time you took to provide feedback and comments on the study. We assure you that we are considering your thoughts and making necessary adjustments to the study's recommendations in order to improve access, mobility, and safety for all users of Highway 83.

This study is a long-term plan. The majority of the recommendations that we have shown will not happen unless there's redevelopment of a property, major changes to the highway, or if multiple property owners and the County decide that they want to work together to create an alternative access—such as creating access to a future signal. Thus, if a property does not redevelop (significant change in land use) it will continue to have access to the highway, although it may be restricted to something less than full movement in the future. Also, as traffic increases or a highway improvement project adds lanes, this plan provides guidance on where future traffic signals may be located. In addition, the plan provides opportunities for the creation of alternative access so that most adjacent properties would have direct access to Highway 83 at a signalized location, which will improve safety.

You provided the following comments/questions about the study:

- I moved to my present location in 1999 and have seen a tremendous increase in traffic on roads crossing Hwy 83 and through Black Forest. As a lifelong cyclist this has caused me to plan my routes and time of day more carefully in order to reduce the chance of injuries or death. Unfortunately, the lack of shoulders or too narrow shoulders has resulted in some too close encounters. Wearing bright colors and operating flashing lights helps but road and intersection design is even more important to make cyclists visible in the hilly and curvy terrain. Please consider the needs of the cycling community in your long-range plans. If this means working with the county to consider building trail systems connecting regional parks or paralleling 83 that would benefit so many citizens, the extra effort to coordinate would be welcome by all of us!

In response to your comment: The County and Colorado Department of Transportation (CDOT) both recognize the importance of providing multi-modal/recreation travel along highways and roads. All of the recommendations in the study help to reduce or better locate the number of access points on Highway 83. This helps reduce the number of conflict spots where cyclists, such as yourself, may encounter traffic crossing your path. It is beyond the scope of this study to make recommendations about trails or paths that could provide safer multi-modal travel. Those recommendations would occur as part of a separate study that would be conducted by the County and/or CDOT. However, none of the recommendations in this study would prohibit/preclude such improvements from occurring in the future under another project.

We recommend you visit the City of Colorado Springs' and El Paso County's websites to view their long-term plans for future bike and trail connections in the vicinity of the corridor. Other documents that have recommended multi-modal improvements in the area include:

- City of Colorado Springs Bike Master Plan: <https://coloradosprings.gov/bikes/page/bike-master-plan>
- El Paso County 2040 Major Transportation Corridor Plan: <https://publicworks.elpasoco.com/road-bridge-planning/mtcp/>

In summary:

- It is beyond the scope of this study to make recommendations about trails or paths that could provide safer multi-modal travel.
- None of the recommendations in this study would prohibit/preclude such improvements from occurring in the future under another project.

We would encourage you to watch for announcements about possible additional meetings in the near future and invite you to continue to participate in shaping the final outcomes of the Highway 83 Access Study.

Thanks again for your participation and comments. If you require additional communication from the project team, please do not hesitate to contact one of us.

Valerie Vigil
Colorado Department of Transportation, Permits Manager
Valerie.Vigil@state.co.us

Victoria Chavez
El Paso County, Principal Transportation Planner
VictoriaChavez@elpasoco.com

Jennifer Irvine
El Paso County, County Engineer
JenniferIrvine@elpasoco.com

David Sprague, PE
Consultant Project Manager
David.Sprague@atkinsglobal.com

CO 83 ACP Stakeholder Responses

Category 2: Try email first and then do phone call if still needed.

Dear Doug Burwell,

The City of Colorado Springs, El Paso County (County), and the Colorado Department of Transportation (CDOT), would like to thank you for taking the time to participate in the Highway 83 Access Study virtual Open House that recently concluded in March of 2021. We appreciate the time you took to provide feedback and comments on the study. We assure you that we are considering your thoughts and making necessary adjustments to the study's recommendations in order to improve access, mobility, and safety for all users of Highway 83.

This study is a long-term plan. The majority of the recommendations that we have shown will not happen unless there's redevelopment of a property, major changes to the highway, or if multiple property owners and the County decide that they want to work together to create an alternative access—such as creating access to a future signal. Thus, if a property does not redevelop (significant change in land use) it will continue to have access to the highway, although it may be restricted to something less than full movement in the future. Also, as traffic increases or a highway improvement project adds lanes, this plan provides guidance on where future traffic signals may be located. In addition, the plan provides opportunities for the creation of alternative access so that most adjacent properties would have direct access to Highway 83 at a signalized location, which will improve safety.

You provided the following comments/questions about the study:

- We have no issues with your project around our area, #39, Arena Rd. BUT, until 2045, could there be at least plans to put in for a one car turning lane into Arena Rd going north on Route 83? Currently there is a turning lane, but only for south bound vehicles turning into High Forest Ranch. There is enough marked for probably 10 cars going south, but zero for a car going north and turning into Arena. In the past, there was a least a break in the double yellow lines, but today there is no break. This suggestion is just a paint design change. Could it please be done the next time the lines are painted (I am guessing 2021 or 2022)?

In response to your comment: The purpose of the access study is to determine the location and type of access that will be allowed along Highway 83. This study does not make recommendations regarding design elements of an access points, such as turn lanes or striping configurations. It should be noted, that the distance between Arena Road and High Forest Road to the south is not long enough to allow a southbound left turn lane at High Forest Road, which already exists, and a northbound left turn lane at Arena Road to be back to back. Highway 83 would have to undergo significant widening to allow both left tun lanes to exist. Furthermore, the existing traffic volumes are not high enough at Arena Road to warrant a dedicated left turn lane. As shown in the plans, the ideal solution would be to realign Arena Road to intersect with Highway 83 at the existing High Forest Road intersection. This would create a single access location and should this intersection warrant a traffic signal, the individuals that use Arena Road would benefit from the safety of accessing Highway 83 at an intersection controlled by a traffic signal. Finally, please keep in mind that this access study is developing the long-range vision for Highway 83. The study recommendations are intended to help the County and CDOT map out solutions to improve access to Highway 83 that can be implemented in the future when operational/safety issues arise, redevelopment occurs, or a highway improvement project occurs.

In summary:

- This study reviews access locations and their movements only but does not make recommendations regarding design elements of an access points, such as turn lanes or striping configurations.
- The distance between Arena Road and High Forest Road to the south is not long enough to allow a southbound left turn lane at High Forest Road, which already exists, and a northbound left turn lane at Arena Road without significant widening of the highway.
- The existing traffic volumes are not high enough at Arena Road to warrant a dedicated left turn lane.
- The ideal solution would be to realign Arena Road to intersect with Highway 83 at the existing High Forest Road intersection, which would improve access spacing, continue to allow full movement to the highway for those using Arena Road, and provide potential safety benefits should the location require a traffic signal in the future.

We would encourage you to watch for announcements about possible additional meetings in the near future and invite you to continue to participate in shaping the final outcomes of the Highway 83 Access Study.

Thanks again for your participation and comments. If you require additional communication from the project team, please do not hesitate to contact one of us.

Valerie Vigil
Colorado Department of Transportation, Permits Manager
Valerie.Vigil@state.co.us

Victoria Chavez
El Paso County, Principal Transportation Planner
VictoriaChavez@elspasoco.com

Jennifer Irvine
El Paso County, County Engineer
JenniferIrvine@elspasoco.com

David Sprague, PE
Consultant Project Manager
David.Sprague@atkinsglobal.com

CO 83 ACP Stakeholder Responses

Category 2: Try email first and then do phone call if still needed.

Dear Felix Uhlak,

The City of Colorado Springs, El Paso County (County), and the Colorado Department of Transportation (CDOT), would like to thank you for taking the time to participate in the Highway 83 Access Study virtual Open House that recently concluded in March of 2021. We appreciate the time you took to provide feedback and comments on the study. We assure you that we are considering your thoughts and making necessary adjustments to the study's recommendations in order to improve access, mobility, and safety for all users of Highway 83.

This study is a long-term plan. The majority of the recommendations that we have shown will not happen unless there's redevelopment of a property, major changes to the highway, or if multiple property owners and the County decide that they want to work together to create an alternative access—such as creating access to a future signal. Thus, if a property does not redevelop (significant change in land use) it will continue to have access to the highway, although it may be restricted to something less than full movement in the future. Also, as traffic increases or a highway improvement project adds lanes, this plan provides guidance on where future traffic signals may be located. In addition, the plan provides opportunities for the creation of alternative access so that most adjacent properties would have direct access to Highway 83 at a signalized location, which will improve safety.

You provided the following comments/questions about the study:

- I'm a member of the Hawk Ridge HOA. Hawk Ridge abuts Hwy 83 near the Palmer Divide intersection. Residents are concerned about a possible roundabout project at this intersection. Can you provide the status and rationale? How would a roundabout work along a highway that has 55 mph speed limit and truck traffic?

In response to your comment: The access study recommends that the intersection of Highway 83 and Palmer Divide remain full movement in the future. Future design projects by CDOT and/or the County will determine whether the intersection will remain under the control of a traffic signal or be converted to a roundabout. A roundabout would be considered because of the ability for roundabouts to efficiently process traffic, accommodate vehicles of all sizes, and compared to a traffic signal, roundabouts result in fewer severe crashes that result in injuries. The design of a roundabout at this location would follow all current federally approved design standards, and industry practices, to ensure vehicles are slowed down to a safe entry speed, below 30 mph, and the roundabout would have a large enough circulating roadway radius to allow large trucks to safely navigate through the intersection. If a roundabout was to be constructed at this intersection, additional public outreach would be completed to allow participation by citizens to review the design, ask questions, and provide comments.

In summary:

- A roundabout is a possibility at the Highway 83 and Palmer Divide Road intersection.
- The design of a roundabout at this location would follow all current federally approved design standards, and industry practices, to ensure vehicles are slowed to a safe entry speed, below 30 mph, and the roundabout would have a large enough circulating roadway radius to allow large trucks to safely navigate through the intersection.

- Additional public outreach would occur during the design of the roundabout which would allow citizens, such as yourself, the opportunity to review the design, ask questions, and provide comments.

We would encourage you to watch for announcements about possible additional meetings in the near future and invite you to continue to participate in shaping the final outcomes of the Highway 83 Access Study.

Thanks again for your participation and comments. If you require additional communication from the project team, please do not hesitate to contact one of us.

Valerie Vigil
Colorado Department of Transportation, Permits Manager
Valerie.Vigil@state.co.us

Victoria Chavez
El Paso County, Principal Transportation Planner
VictoriaChavez@elpasoco.com

Jennifer Irvine
El Paso County, County Engineer
JenniferIrvine@elpasoco.com

David Sprague, PE
Consultant Project Manager
David.Sprague@atkinsglobal.com

CO 83 ACP Stakeholder Responses

Category 2: Try email first and then do phone call if still needed.

Dear Gary Cox,

The City of Colorado Springs, El Paso County (County), and the Colorado Department of Transportation (CDOT), would like to thank you for taking the time to participate in the Highway 83 Access Study virtual Open House that recently concluded in March of 2021. We appreciate the time you took to provide feedback and comments on the study. We assure you that we are considering your thoughts and making necessary adjustments to the study's recommendations in order to improve access, mobility, and safety for all users of Highway 83.

This study is a long-term plan. The majority of the recommendations that we have shown will not happen unless there's redevelopment of a property, major changes to the highway, or if multiple property owners and the County decide that they want to work together to create an alternative access—such as creating access to a future signal. Thus, if a property does not redevelop (significant change in land use) it will continue to have access to the highway, although it may be restricted to something less than full movement in the future. Also, as traffic increases or a highway improvement project adds lanes, this plan provides guidance on where future traffic signals may be located. In addition, the plan provides opportunities for the creation of alternative access so that most adjacent properties would have direct access to Highway 83 at a signalized location, which will improve safety.

You provided the following comments/questions about the study:

- I live on Highway 83 and am very interested that the project is going to make the entrance accesses in the proper location. I live at 15740 State Highway 83 and the entrance is in the wrong location. Several years ago, when I went to the department on getting a permit to move the exit, they were aware of the location problem. When Flying Horse North did the road improvement, they were allowed to work our entrance but CDOT(Pueblo) never did not have them correct the problem. We have an entrance that services 6 families and other homes may have to come on our entrance the way I understand it. We presently exit on the number 32 and it shows no place for the people on this exit 6 families to go? I see no gray bar leading to number 79 or to number 28/29

In response to your comments/questions:

For clarification, access #31 and #32 are located directly adjacent to each other (on either side of the utility pole) along Highway 83. There should only be a single access point at this location and that is access #31. Access #32 is considered a secondary access for the properties that use it and according to the State of Colorado State Highway Access Code, secondary accesses to the same properties can be closed, if it is not already.

The gray bars or new access roads shown in the draft plan are merely a recommendation. The County and the Colorado Department of Transportation could only require the property owners to pursue or implement such a recommendation if the land use changes that requires a Local Agency process such as subdivision or zone change. The same is true for the recommended cross access agreements. The plan makes suggestions about properties where the owners could work together to develop cross access agreements in order to combine or share access locations.

If the property owners around the proposed access #79 all agreed to allow cross access between their properties, or if all the properties surrounding access #79 were to be redeveloped as part of a large project, then at that time access points #31, #32, #33, and #35 would be closed. All of the properties, or the single larger redeveloped property, would obtain access from the new location at #79. Access #79 is shown in a location that maximizes the distance between other nearby access locations so that turn lanes could be installed if traffic volumes warrant them.

If the property owners do not agree to allow cross access, or if the surrounding properties are not redeveloped (their land use does not change), then access point #32 would be closed and #31 would remain open. In this case, access #79 would never be constructed. In addition, the position of the access roads (gray bars) as shown in the draft plan are for informational purposes only. If access #79 was to be built because cross access agreements were agreed upon, then the final location and design of these new connections to access #79 (width, surface materials, etc.) would be determined by the property owners through a design process.

However, it should be noted that keeping access #31 open does not guarantee that this access will continue to provide full access to Highway 83. If access #31 is determined to have a safety issue, if a median is constructed on Highway 83 as part of an improvement project, or if your property was to redevelop (change land use) then #31 may be restricted to a right-in, right-out or three-quarter access.

In summary:

- For clarification, access #31 and #32 are located directly adjacent to each other along Highway 83. There should only be a single access point at this location and that is access #31. Access #32 is considered a secondary access for the properties that use it and will be closed if it is not already.
- All access road (gray bars) shown in the draft plan are merely a recommendation and are shown for informational purposes only.
- The County and the Colorado Department of Transportation do not have any authority to require the property owners to pursue or implement cross access agreements or to construction access roads (gray bars).
- There is no requirement of the property owners to pursue this option, it is presented as an option to would help reduce access points, provide shared access at a location that is better located along the highway, and could be designed to provide safe access the highway.
- If the property owners do not agree to allow cross access and if the properties in the area are not redeveloped as part of a large project, then access points #31 would remain open. Access #79 would not be constructed.
- Access #31 will not be closed until cross access agreement is reached with adjacent properties and alternative access to Highway 83 is in place at #79.
- If access #31 is determined to have a safety issue, if a median is constructed on Highway 83 as part of an improvement project, or if your property was to redevelop (change land use) then #31 may be restricted to a right-in, right-out or three-quarter access.

We would encourage you to watch for announcements about possible additional meetings in the near future and invite you to continue to participate in shaping the final outcomes of the Highway 83 Access Study.

Thanks again for your participation and comments. If you require additional communication from the project team, please do not hesitate to contact one of us.

Valerie Vigil

Colorado Department of Transportation, Permits Manager

Valerie.Vigil@state.co.us

Victoria Chavez

El Paso County, Principal Transportation Planner

VictoriaChavez@elpasoco.com

Jennifer Irvine

El Paso County, County Engineer

JenniferIrvine@elpasoco.com

David Sprague, PE

Consultant Project Manager

David.Sprague@atkinsglobal.com

CO 83 ACP Stakeholder Responses

Category 2: Try email first and then do phone call if still needed.

Dear Herb and Teri Walder,

The City of Colorado Springs, El Paso County (County), and the Colorado Department of Transportation (CDOT), would like to thank you for taking the time to participate in the Highway 83 Access Study virtual Open House that recently concluded in March of 2021. We appreciate the time you took to provide feedback and comments on the study. We assure you that we are considering your thoughts and making necessary adjustments to the study's recommendations in order to improve access, mobility, and safety for all users of Highway 83.

This study is a long-term plan. The majority of the recommendations that we have shown will not happen unless there's redevelopment of a property, major changes to the highway, or if multiple property owners and the County decide that they want to work together to create an alternative access—such as creating access to a future signal. Thus, if a property does not redevelop (significant change in land use) it will continue to have access to the highway, although it may be restricted to something less than full movement in the future. Also, as traffic increases or a highway improvement project adds lanes, this plan provides guidance on where future traffic signals may be located. In addition, the plan provides opportunities for the creation of alternative access so that most adjacent properties would have direct access to Highway 83 at a signalized location, which will improve safety.

You provided the following comments/questions about the study:

- We own the property known as 40 on the map of the proposed Highway 83 access. We are seeing that both our driveways into 83, directly off of 83, and our access into our property on Arena Road show access closed. We're wondering what proposed cross/shared property access means for our ingress and egress to our property. We bought the property because it did have 2 entrances into the property, and we liked that option. We have thousands of dollars spent on asphalt and cement to pave our driveway into our property, which will now be unusable with the access closed. With access closed on both driveways, we want to know what your proposal is to give us access to our property and the other homeowners who access Arena Road to get to their homes.

In response to your comment: Although the draft plan does recommend the closure of access #40, the draft plan also identifies a series of conditions that must be satisfied before this change would occur. Access #40 would not be closed unless other access could be provided to your property. This additional access could be provided from Arena Road, which according to your comment already exists. Since this access already exists, access #40 is considered a secondary access to your property and according to the State of Colorado State Highway Access Code, this secondary access can be closed.

However, at this time there are no plans to close access #40, but if safety or operational concerns are identified at this location or if a highway improvement project is done along Highway 83 then it is possible that access #40 would be closed. If this were to occur, the affected property owner will receive notification of the impending action. This notification provides the property owner with a due process period (minimum of 30 calendar days) as prescribed by law to appeal the action.

The draft plan does recommend the closure of access #39 (Arena Road). However, access #39 would be closed only if Arena Road was to be realigned to the south and connect to Highway 83 at a new intersection (access #80) that is aligned with High Forest Road. In order for this to occur, the neighboring properties would have to work together to create cross access agreements that would allow Arena Road to be realigned and connect to Highway 83 further to the south. The County and CDOT could only require the property owners to pursue or implement such a recommendation if the land use changes that requires a Local Agency process such as subdivision or zone change. At this time the County nor CDOT are not aware of any plans or projects identified that would realign Arena Road.

If Arena Road was to be realigned to the south, the new High Forest Road/Arena Road and Highway 83 intersection would be a full movement (all turns are allowed) and may have a traffic signal in the future. Having access to an intersection with a traffic signal would provide you with a safe way to move between your property and Highway 83. If cross access agreements are not obtained and Arena Road is not realigned, then access #39 (Arena Road) would remain open at its current location. However, it should be noted that keeping access #39 open does not guarantee that it will remain a full movement access to Highway 83. If access #39 is determined to have a safety issue, if a median is constructed on Highway 83 as part of an improvement project, or if the adjacent properties in the area redevelop (change land use) then #39 may be restricted to a right-in, right-out or three-quarter access.

In summary:

- Access #40 is a secondary access to your property because you have access to Arena Road, which means that access #40 is a candidate to be closed.
- At this time there are no plans to close access #40, but if safety concerns are identified at this location or if a highway improvement project is done along Highway 83 then it is possible that access #40 would be closed and you would access your property from Arena Road.
- Access #39 would be closed only if Arena Road was to be realigned to the south and connect to Highway 83 at a new intersection (access #80) that is aligned with High Forest Road.
- If Arena Road is not realigned, then access #39 (Arena Road) would remain open at its current location.
- If access #39 is determined to have a safety issue, if a median is constructed on Highway 83 as part of an improvement project, or if the adjacent properties in the area redevelop (change land use) then #39 may be restricted to a right-in, right-out or three-quarter access.

We would encourage you to watch for announcements about possible additional meetings in the near future and invite you to continue to participate in shaping the final outcomes of the Highway 83 Access Study.

Thanks again for your participation and comments. If you require additional communication from the project team, please do not hesitate to contact one of us.

Valerie Vigil
Colorado Department of Transportation, Permits Manager
Valerie.Vigil@state.co.us

Victoria Chavez
El Paso County, Principal Transportation Planner
VictoriaChavez@elspasoco.com

Jennifer Irvine
El Paso County, County Engineer
JenniferIrvine@elpasoco.com

David Sprague, PE
Consultant Project Manager
David.Sprague@atkinsglobal.com

CO 83 ACP Stakeholder Responses

Category 2: Try email first and then do phone call if still needed.

Dear representative of the Herbertson Family Trust,

The City of Colorado Springs, El Paso County (County), and the Colorado Department of Transportation (CDOT), would like to thank you for taking the time to participate in the Highway 83 Access Study virtual Open House that recently concluded in March of 2021. We appreciate the time you took to provide feedback and comments on the study. We assure you that we are considering your thoughts and making necessary adjustments to the study's recommendations in order to improve access, mobility, and safety for all users of Highway 83.

This study is a long-term plan. The majority of the recommendations that we have shown will not happen unless there's redevelopment of a property, major changes to the highway, or if multiple property owners and the County decide that they want to work together to create an alternative access—such as creating access to a future signal. Thus, if a property does not redevelop (significant change in land use) it will continue to have access to the highway, although it may be restricted to something less than full movement in the future. Also, as traffic increases or a highway improvement project adds lanes, this plan provides guidance on where future traffic signals may be located. In addition, the plan provides opportunities for the creation of alternative access so that most adjacent properties would have direct access to Highway 83 at a signalized location, which will improve safety.

You provided the following comments about access number 47:

- I want to know when this project was submitted to the county and why parties were not notified prior to discuss the severe impact this has on the property owners effected by this proposal.
- There is one access to my property that recently went through an evaluation in 2020 with no comments regarding this change. How do I gain access to my property if you close the only access?

In response to your first comment: This project is in the study process and has not been finalized. At this time no decisions are final and the materials you have reviewed are considered draft and still under development. El Paso County has been working with the Department of Transportation to develop the draft plan as presented in the virtual meeting last month. The virtual meeting was our first effort to receive input from concerned citizens such as yourself.

In response to your second comment: Although the draft plan does recommend the closure of access #47, the draft plan also identifies a series of conditions that must be satisfied before this change would occur. Access #47 would not be closed unless other access could be provided to your property. This additional access could be provided if you and the neighboring properties worked together to create a cross access agreement that would provide your property with an alternative means to access Highway 83. This could include the construction of an access road that would connect between your property and Walden Way. The Walden Way and Highway 83 intersection will remain full movement and may have a traffic signal in the future. Having access to an intersection with a traffic signal would provide you with a safe way to move between your property and Highway 83. If cross access agreements are not obtained and this alternative access is not created, then access #47 would remain open at its current location.

Basically, if your property remains a single-family home, you will continue to have direct access to Highway 83 at access #47. However, if in the future your property was to redevelop or even subdivide, the new development would benefit by having access to an intersection that may be controlled by a traffic signal and that location would be Walden Way. At such time, access #47 would be restricted to less than full movement or closed and the construction of access roads to Walden Way would be needed.

In addition, the position of the access roads (gray bars) as shown in the draft plan are for informational purposes only. If cross access agreements were agreed upon, then the final location and design of these new connections to access #51 (width, surface materials, etc.) would be determined by the property owners through a design process.

However, it should be noted that keeping access #47 open does not guarantee that your property will have full access to Highway 83. If access #47 is determined to have a safety issue, if a median is constructed on Highway 83 as part of an improvement project, or if your property was to redevelop (change land use) then #47 may be restricted to a right-in, right-out or three-quarter access.

In summary:

- Access #47 will not be closed until cross access agreement is reached with adjacent properties and alternative access to Walden Way is in place.
- If access #47 is determined to have a safety issue, if a median is constructed on Highway 83 as part of an improvement project, or if your property was to redevelop (change land use) then #47 may be restricted to a right-in, right-out or three-quarter access.

We would encourage you to watch for announcements about possible additional meetings in the near future and invite you to continue to participate in shaping the final outcomes of the Highway 83 Access Study.

Thanks again for your participation and comments. If you require additional communication from the project team, please do not hesitate to contact one of us.

Valerie Vigil
Colorado Department of Transportation, Permits Manager
Valerie.Vigil@state.co.us

Victoria Chavez
El Paso County, Principal Transportation Planner
VictoriaChavez@elpasoco.com

Jennifer Irvine
El Paso County, County Engineer
JenniferIrvine@elpasoco.com

David Sprague, PE
Consultant Project Manager
David.Sprague@atkinsglobal.com

CO 83 ACP Stakeholder Responses

Category 2: Try email first and then do phone call if still needed.

Dear Jean-Baptiste Lafon,

The City of Colorado Springs, El Paso County (County), and the Colorado Department of Transportation (CDOT), would like to thank you for taking the time to participate in the Highway 83 Access Study virtual Open House that recently concluded in March of 2021. We appreciate the time you took to provide feedback and comments on the study. We assure you that we are considering your thoughts and making necessary adjustments to the study's recommendations in order to improve access, mobility, and safety for all users of Highway 83.

This study is a long-term plan. The majority of the recommendations that we have shown will not happen unless there's redevelopment of a property, major changes to the highway, or if multiple property owners and the County decide that they want to work together to create an alternative access—such as creating access to a future signal. Thus, if a property does not redevelop (significant change in land use) it will continue to have access to the highway, although it may be restricted to something less than full movement in the future. Also, as traffic increases or a highway improvement project adds lanes, this plan provides guidance on where future traffic signals may be located. In addition, the plan provides opportunities for the creation of alternative access so that most adjacent properties would have direct access to Highway 83 at a signalized location, which will improve safety.

You provided the following comments/questions about the study:

- I don't understand why Powers is not completed to I25?

In response to your comment: The purpose of the access study is to determine where access should be allowed on Highway 83. The Powers Boulevard extension to I-25 is a planned improvement in the future but is outside the scope of this project. The access study has identified and preserved the access locations to allow Powers Boulevard to connect to Highway 83 should the roadway be extended to I-25. These accesses are shown as Accesses 1 and 73 (future Powers Boulevard southbound off and on-ramps) and Accesses 2 and 74 (future Powers Boulevard northbound off and on-ramps). It is beyond the scope of this study to make the recommendation for Powers Boulevard to be extended, but the study has provided recommendations that would allow access between Highway 83 and Powers Boulevard should the extension occur in the future.

The future extension of Powers Boulevard would have some impact on Highway 83, primarily in the level of traffic that would use Highway 83 versus using the new extension of Powers. However, the extension of Powers Boulevard would not have an impact on the recommendations shown in the access study.

Your thoughts about considering grade separations or interchanges along Highway 83 at the major crossroads was given consideration as we developed our recommendations. While our recommendations do not include specific locations for interchanges, the goal of our study is not to eliminate or preclude such improvements from occurring in the future. However, before building such a large infrastructure improvement, the Colorado Department of Transportation (CDOT) and the County would work together to complete a detailed study of the environmental impacts, needed right-of-way, drainage improvements, costs to construct/maintain, and other factors to determine if an interchange would be desirable at any intersection along Highway 83.

In summary:

- The Colorado Department of Transportation (CDOT) and the County would work together to complete a detailed study of the environmental impacts, needed right-of-way, drainage improvements, costs to construct/maintain, and other factors to determine if an interchange would be desirable at any intersection along Highway 83
- It is beyond the scope of this study to make the recommendation for Powers Boulevard to be extended, but the study has provided recommendations that would allow access between Highway 83 and Powers Boulevard should the extension occur in the future.

We would encourage you to watch for announcements about possible additional meetings in the near future and invite you to continue to participate in shaping the final outcomes of the Highway 83 Access Study.

Thanks again for your participation and comments. If you require additional communication from the project team, please do not hesitate to contact one of us.

Valerie Vigil
Colorado Department of Transportation, Permits Manager
Valerie.Vigil@state.co.us

Victoria Chavez
El Paso County, Principal Transportation Planner
VictoriaChavez@elpasoco.com

Jenifer Irvine
El Paso County, County Engineer
JenniferIrvine@elpasoco.com

David Sprague, PE
Consultant Project Manager
David.Sprague@atkinsglobal.com

CO 83 ACP Stakeholder Responses

Category 2: Try email first and then do phone call if still needed.

Dear Jess Neal,

The City of Colorado Springs, El Paso County (County), and the Colorado Department of Transportation (CDOT), would like to thank you for taking the time to participate in the Highway 83 Access Study virtual Open House that recently concluded in March of 2021. We appreciate the time you took to provide feedback and comments on the study. We assure you that we are considering your thoughts and making necessary adjustments to the study's recommendations in order to improve access, mobility, and safety for all users of Highway 83.

This study is a long-term plan. The majority of the recommendations that we have shown will not happen unless there's redevelopment of a property, major changes to the highway, or if multiple property owners and the County decide that they want to work together to create an alternative access—such as creating access to a future signal. Thus, if a property does not redevelop (significant change in land use) it will continue to have access to the highway, although it may be restricted to something less than full movement in the future. Also, as traffic increases or a highway improvement project adds lanes, this plan provides guidance on where future traffic signals may be located. In addition, the plan provides opportunities for the creation of alternative access so that most adjacent properties would have direct access to Highway 83 at a signalized location, which will improve safety.

You provided the following comments/questions about the study:

- My concerns are this, the section of highway from County Line Road south to Powers is currently an extremely heavily traveled road and that will only increase as northern residential development increases. The other problem is 83 is the only alternate route when there is an incident on I-25. I have personally seen traffic bumper to bumper, solid cars from north of County Line to North Gate because of problems on I-25. The only SAFE answer and one which I never saw in the presentation anywhere is to make 83 the same as Powers over Union meaning cross traffic would have to go under 83.
- This is especially important at 105/Walker where the new charter school will create traffic backup problems directly on 83 during periods of the day when the traffic will be heaviest. The deadly consequences of this situation cannot be overstated. I know the first response will be cost. The problem with that is the bare minimum is always done then public outcry drives the decision makers to fix the situation which means more money is spent which eventually adds up to be the same as the cost had the job been done properly the first time.

In response to your first comment: The purpose of the access study is to determine where access should be allowed on Highway 83. Your thoughts about considering grade separations or interchanges along Highway 83 at the major crossroads was given consideration as we developed our recommendations. While our recommendations do not include specific locations for interchanges, the goal of our study is not to eliminate or preclude such improvements from occurring in the future. However, before building such a large infrastructure improvement, the Colorado Department of Transportation (CDOT) and the County would work together to complete a detailed study of the environmental impacts, needed right-of-way, drainage improvements, costs to construct/maintain, and other factors to determine if an interchange would be desirable at any intersection along Highway 83.

In addition, the County has identified that Highway 83 through most of the study area will be expanded from 2 to 4, or from 4 to 6 lanes between now and 2040. With these capacity improvements and with other anticipated improvements at intersections to add turn lanes, many of the congestion issues experienced now will be improved. Our efforts in this study are to identify where and what kind of intersections will be allowed in the future, so that when the improvements are designed and constructed, the improvements will be long-lasting.

In response to your second comment: Your concern about traffic backing up onto Highway 83 and the resulting safety implications from such an event are considered important by the project team. The access study cannot directly address the potential for this issue to arise, but CDOT and the County will need to monitor the traffic situation in the area and should traffic backup onto Highway 83, as you have identified, then this issue will be evaluated and addressed with the school at that time.

In summary:

- The Colorado Department of Transportation (CDOT) and the County would work together to complete a detailed study of the environmental impacts, needed right-of-way, drainage improvements, costs to construct/maintain, and other factors to determine if an interchange would be desirable at any intersection along Highway 83.
- This study does not preclude such improvements from occurring along Highway 83 in the future.
- The access study cannot directly address the potential for traffic to back up onto the Highway from the school, but CDOT and the County will need to monitor the traffic situation in the area and should traffic backup onto Highway 83, as you have identified, then this issue will be evaluated and addressed with the school at that time.

We would encourage you to watch for announcements about possible additional meetings in the near future and invite you to continue to participate in shaping the final outcomes of the Highway 83 Access Study.

Thanks again for your participation and comments. If you require additional communication from the project team, please do not hesitate to contact one of us.

Valerie Vigil
Colorado Department of Transportation, Permits Manager
Valerie.Vigil@state.co.us

Victoria Chavez
El Paso County, Principal Transportation Planner
VictoriaChavez@elpasoco.com

Jennifer Irvine
El Paso County, County Engineer
JenniferIrvine@elpasoco.com

David Sprague, PE
Consultant Project Manager
David.Sprague@atkinsglobal.com

CO 83 ACP Stakeholder Responses

Category 2: Try email first and then do phone call if still needed.

Dear Josh McDowell,

The City of Colorado Springs, El Paso County (County), and the Colorado Department of Transportation (CDOT), would like to thank you for taking the time to participate in the Highway 83 Access Study virtual Open House that recently concluded in March of 2021. We appreciate the time you took to provide feedback and comments on the study. We assure you that we are considering your thoughts and making necessary adjustments to the study's recommendations in order to improve access, mobility, and safety for all users of Highway 83.

This study is a long-term plan. The majority of the recommendations that we have shown will not happen unless there's redevelopment of a property, major changes to the highway, or if multiple property owners and the County decide that they want to work together to create an alternative access—such as creating access to a future signal. Thus, if a property does not redevelop (significant change in land use) it will continue to have access to the highway, although it may be restricted to something less than full movement in the future. Also, as traffic increases or a highway improvement project adds lanes, this plan provides guidance on where future traffic signals may be located. In addition, the plan provides opportunities for the creation of alternative access so that most adjacent properties would have direct access to Highway 83 at a signalized location, which will improve safety.

You provided the following comments/questions about access number 51:

- We recently purchased 3270 Outlook Dr, which is currently on a cul-de-sac off of Kaessner. I noticed the study recommended two roads through our property—one entering from 83 and one going up to Stagecoach. Is there anyone we can discuss the placement of these roads? As you can imagine, seeing two new roads going through our property is a cause for concern, especially since we purchased the land for its privacy. Also, the planned road looks like it would run right up my driveway (or along my fence line just feet off my driveway).

In response to your comments/questions: The access plan is an ultimate vision for the highway as redevelopment occurs or if an operational or safety issues is identified at existing access locations. One goal of the access study is to maximize the distance between access points. This allows more access locations to potentially be controlled by a traffic signal and also allows for maximum access between adjacent properties and Highway 83.

The access roads shown as a gray bar on the maps, would only be constructed if the property owners agreed to enter into a cross access agreement or if all of the properties in the area were to redevelop as a single property. The County and the Colorado Department of Transportation could only require the property owners to pursue or implement such a recommendation if the land use changes that requires a Local Agency process such as subdivision or zone change. In addition, there is no requirement of the property owners to pursue this option. If the property owners do not agree to allow cross access and if the properties are not redeveloped, then the access roads would not be constructed.

If the property owners agreed to allow cross access between the properties, or if the properties in the area redeveloped as part of a large project, then the access roads would be constructed and access point #25 (Kaessner Lane) would be closed. In addition, the position of the access roads as shown in the

draft plan is for informational purposes only. If the access roads were to be constructed, then the final location and design of the roads (width, surface materials, etc.) would be determined by the property owners through a design process including the option to move the road to a different location or for the roads to be constructed in such a manner as to cause minimal disruption to properties and open spaces.

However, it should be noted that keeping access #25 (Kaessner Lane) open does not guarantee that your property will have full access to Highway 83 at this location. If access #25 is determined to have an operational or safety issue, if a median is constructed on Highway 83 as part of an improvement project, or if adjacent properties redevelop (change land use) then #25 may be restricted to a right-in, right-out or three-quarter access. Having an access road to an adjacent roadway may continue to provide full movement access to your property and it may be an intersection with a traffic signal if the property east of Highway 83 redevelops in the future. An intersection controlled by a traffic signal would be a safer access point for you to make movements onto and off of Highway 83.

In summary:

- The access road shown as a gray bar on the maps, would only be constructed if the property owners agreed to enter into a cross access agreement or if all of the properties in the area were to redevelop as a single property.
- The County and the Colorado Department of Transportation could only require the property owners to pursue or implement such a recommendation if the land use changes that requires a Local Agency process such as subdivision or zone change.
- There is no requirement of the property owners to pursue this option.
- If the property owners do not agree to allow cross access and the properties in the area are not redeveloped as part of a large project, then access road would not be constructed.
- The position of the access road as shown in the draft plan is for informational purposes only.
- If the access road is constructed, then the final location and design of the road (width, surface materials, etc.) would be determined by the property owners through a design process, including the option to move the road to the rear of the properties or to be constructed in such a manner as to cause minimal disruption to properties and open spaces.
- It should be noted that keeping access #25 (Kaessner Lane) open does not guarantee that your property will have full access to Highway 83 at this location.
- Having an access road to an adjacent roadway may continue to provide full movement access to your property and it may be an intersection with a traffic signal, which would be a safer access point for you to make movements onto and off of Highway 83.

We would encourage you to watch for announcements about possible additional meetings in the near future and invite you to continue to participate in shaping the final outcomes of the Highway 83 Access Study.

Thanks again for your participation and comments. If you require additional communication from the project team, please do not hesitate to contact one of us.

Valerie Vigil
Colorado Department of Transportation, Permits Manager
Valerie.Vigil@state.co.us

Victoria Chavez

El Paso County, Principal Transportation Planner
VictoriaChavez@elpasoco.com

Jennifer Irvine
El Paso County, County Engineer
JenniferIrvine@elpasoco.com

David Sprague, PE
Consultant Project Manager
David.Sprague@atkinsglobal.com

CO 83 ACP Stakeholder Responses

Category 2: Try email first and then do phone call if still needed.

Dear Terry Mertink,

The City of Colorado Springs, El Paso County (County), and the Colorado Department of Transportation (CDOT), would like to thank you for taking the time to participate in the Highway 83 Access Study virtual Open House that recently concluded in March of 2021. We appreciate the time you took to provide feedback and comments on the study. We assure you that we are considering your thoughts and making necessary adjustments to the study's recommendations in order to improve access, mobility, and safety for all users of Highway 83.

This study is a long-term plan. The majority of the recommendations that we have shown will not happen unless there's redevelopment of a property, major changes to the highway, or if multiple property owners and the County decide that they want to work together to create an alternative access—such as creating access to a future signal. Thus, if a property does not redevelop (significant change in land use) it will continue to have access to the highway, although it may be restricted to something less than full movement in the future. Also, as traffic increases or a highway improvement project adds lanes, this plan provides guidance on where future traffic signals may be located. In addition, the plan provides opportunities for the creation of alternative access so that most adjacent properties would have direct access to Highway 83 at a signalized location, which will improve safety.

You provided the following comments/questions about the study:

- Making the section between Flying Horse Club Dr and Old North Gate a no air brake section for trucks. We have many large tractor trailer rigs that move along this stretch of the road and the noise level can be tremendous at times. I am not sure if this would be a City of Colorado update of an El Paso County update?
- Put a roundabout at Old North Gate/Hwy 83 or close this intersection. (Access description 12 and 13 on section 2 and 3 of the "Access Control Plan") Is one of these options possible?

In response to your first comment: Engine compression brake devices "Jake" brakes reduce the load on foundation brakes, which helps prevent dangerous brake overheating. This keeps brakes available for emergencies. All commercial vehicles operating on any public roadway in Colorado equipped with an engine compression brake device are required by law to have mufflers in accordance with Colorado Revised Statute 42-4-225.

The Colorado Department of Transportation installs signs stating "engine brake mufflers required" when the local Sheriff will enforce the law. El Paso County has not committed to this enforcement. The presence of these signs alone does not significantly reduce highway noise levels. Even with proper use of mufflers, engine braking still produces a distinct sound. Because they are a safety device, the use of engine brakes is not prohibited on state highways. Prohibiting engine brakes would attempt to solve a noise problem without addressing the real cause, which is that some trucks have improperly muffled exhaust systems.

Your concerns about this issue have been communicated to CDOT, but this type of issue is outside the scope of an access study. Thus, this access study will not make a recommendation regarding the placement of signs requiring the use of engine braking mufflers on Highway 83.

In response to your second comment: The current recommendation for the Old North Gate intersection (access #12 and #13) does include the option to convert the intersection to a roundabout. In order for this change to occur, CDOT would work with the County to perform a traffic study which would evaluate the option of putting a roundabout at this location versus a traffic signal. They would consider impacts to right-of-way, impacts to safety, impacts to mobility, and also overall costs. At the current time, there are no plans to complete such a traffic study at this intersection. This type of study is generally completed at the time when traffic conditions (high traffic volumes) or safety concerns (number of accidents at this location) trigger the need for an improvement to be done. A complete closure of access #12 and/or access #13 will be considered by the project team before finalizing the project recommendations. Before one of both of these accesses can be closed the project would have to identify alternative access to the properties that use them to access Highway 83.

In summary:

- Your concern about the noise in the area due to air brake use by large vehicles has been communicated to CDOT, but this type of issue is outside the scope of an access study. Thus, this access study will not make a recommendation regarding the placement of regulatory signs restricting the use of air brakes by large vehicles.
- Our recommendation for the intersection of Old North Gate and Highway 83 includes the option to convert the intersection to a roundabout. The decision to make this change would require the completion of a traffic study, which is outside the scope of this study.
- A complete closure of access #12 and/or access #13 will be considered by the project team before finalizing the project recommendations.

We would encourage you to watch for announcements about possible additional meetings in the near future and invite you to continue to participate in shaping the final outcomes of the Highway 83 Access Study.

Thanks again for your participation and comments. If you require additional communication from the project team, please do not hesitate to contact one of us.

Very respectfully,

Valerie Vigil
Colorado Department of Transportation, Permits Manager
Valerie.Vigil@state.co.us

Victoria Chavez
El Paso County, Principal Transportation Planner
VictoriaChavez@elpasoco.com

Jennifer Irvine
El Paso County, County Engineer
JenniferIrvine@elpasoco.com

David Sprague, PE
Consultant Project Manager
David.Sprague@atkinsglobal.com

CO 83 ACP Stakeholder Responses

Category 2: Try email first and then do phone call if still needed.

Dear Tom Rhineberger,

The City of Colorado Springs, El Paso County (County), and the Colorado Department of Transportation (CDOT), would like to thank you for taking the time to participate in the Highway 83 Access Study virtual Open House that recently concluded in March of 2021. We appreciate the time you took to provide feedback and comments on the study. We assure you that we are considering your thoughts and making necessary adjustments to the study's recommendations in order to improve access, mobility, and safety for all users of Highway 83.

This study is a long-term plan. The majority of the recommendations that we have shown will not happen unless there's redevelopment of a property, major changes to the highway, or if multiple property owners and the County decide that they want to work together to create an alternative access—such as creating access to a future signal. Thus, if a property does not redevelop (significant change in land use) it will continue to have access to the highway, although it may be restricted to something less than full movement in the future. Also, as traffic increases or a highway improvement project adds lanes, this plan provides guidance on where future traffic signals may be located. In addition, the plan provides opportunities for the creation of alternative access so that most adjacent properties would have direct access to Highway 83 at a signalized location, which will improve safety.

You provided the following comments/questions about access number 51:

- While our property is adjacent to Hwy 83, we access Hwy 83 through Walden Way at point 51. Our neighbors access it through points 47, 48, and 49. This study proposes that "a cross access easement" be "obtained with adjacent property" - basically a service road used by neighboring properties to get to Walden Way. This type of change would reduce our pasture - our property - significantly. I realize that this is a proposal and possible changes to reduce access points. My question is whether or not this is something that is voted on, or what is the approval process before something like this is implemented? Do property owners have any recourse?

In response to your comments/questions: The access plan is an ultimate vision for the highway as redevelopment occurs or if an operational or safety issues is identified at existing access locations. One option for improving safety on Highway 83 is to consolidate access points to a single shared full movement location such as Walden Way. This full movement location, which could ultimately be controlled by a traffic signal, would safely provide access to multiple properties. The intersection could also be designed to include turn lanes, assuming adjacent access points are not too close to the intersection.

The access road shown as a gray bar on the maps, would only be constructed if the property owners agreed to enter into a cross access agreement or if all of the properties in the area were to redevelop as a single property. The County and the Colorado Department of Transportation could only require the property owners to pursue or implement such a recommendation if the land use changes that requires a Local Agency process such as subdivision or zone change. In addition, there is no requirement of the property owners to pursue this option. If the property owners do not agree to allow cross access and if the properties are not redeveloped, then the access road would not be constructed.

If the property owners agreed to allow cross access between the properties, or if the properties in the area redeveloped as part of a large project, then the access road would be constructed and access points #47, #48, and #49 would be closed. In addition, the position of the access road as shown in the draft plan is for informational purposes only. If the access road is constructed, then the final location and design of the road (width, surface materials, etc.) would be determined by the property owners through a design process including the option to move the road to the rear of the properties or to be constructed in such a manner as to cause minimal disruption to pasture and open spaces.

In summary:

- The access road shown as a gray bar on the maps, would only be constructed if the property owners agreed to enter into a cross access agreement or if all of the properties in the area were to redevelop as a single property.
- The County and the Colorado Department of Transportation could only require the property owners to pursue or implement such a recommendation if the land use changes that requires a Local Agency process such as subdivision or zone change.
- There is no requirement of the property owners to pursue this option.
- If the property owners do not agree to allow cross access and the properties in the area are not redeveloped as part of a large project, then access road would not be constructed.
- The position of the access road as shown in the draft plan is for informational purposes only.
- If the access road is constructed, then the final location and design of the road (width, surface materials, etc.) would be determined by the property owners through a design process, including the option to move the road to the rear of the properties or to be constructed in such a manner as to cause minimal disruption to pasture and open spaces..

We would encourage you to watch for announcements about possible additional meetings in the near future and invite you to continue to participate in shaping the final outcomes of the Highway 83 Access Study.

Thanks again for your participation and comments. If you require additional communication from the project team, please do not hesitate to contact one of us.

Very respectfully,

Valerie Vigil
Colorado Department of Transportation, Permits Manager
Valerie.Vigil@state.co.us

Victoria Chavez
El Paso County, Principal Transportation Planner
VictoriaChavez@elpasoco.com

Jennifer Irvine
El Paso County, County Engineer
JenniferIrvine@elpasoco.com

David Sprague, PE
Consultant Project Manager

David.Sprague@atkinsglobal.com

The following are responses sent via letter to individuals that provided comments at the first Highway 83 Access Study virtual meeting and the project team followed up with a one-on-one meeting. These letters summarize the discussion that were held during the one-on-one meetings.



July 7, 2021

Justin Ensor
14650 Highway 83
Colorado Springs, CO 80921

**RE: Property at 14650 Highway 83
CO 83 Access Study
Summary of One-on-One Meeting**

Dear Justin:

On behalf of the entire project team, including El Paso County, the City of Colorado Springs, and the Colorado Department of Transportation (CDOT), I would like to thank you for participating in the on-going CO 83 Access Study. The success of the study depends on public involvement and input. On April 19, 2021, you participated in a one-on-one meeting with representatives from the project team to discuss access to your property at 14650 Highway 83. The following individuals were present at this meeting:

- Justin Ensor, Property Owner
- Victoria Chavez, El Paso County
- Valerie Vigil, CDOT
- David Sprague, Atkins
- Anna Ericson, Atkins

At your meeting, you were provided the opportunity to listen as the project team described the purpose of the study and provided details regarding the current and future access conditions that may have a direct impact to your property. During the meeting, you provided valuable input, which will be taken into consideration as final recommendations are made and the study is completed. The following is a brief summary of the key discussion items and/or decisions that occurred during your meeting:

1. The property of interest (14650 Highway 83) is located west of CO 83 (see **Existing Access Conditions Figure** attached to this letter). The property currently has a full movement access to CO 83 (#23).
2. The project team explained the draft plan recommendations to Justin.
 - a. The existing access (#23) could be restricted to a to less than a full movement access. The access may be restricted to right-in, right-out or ¾ movement if adequate improvements have been made to ensure U-turns can be safely completed at nearby intersections, and
 - An operational and/or safety issues are identified through the completion of a traffic study; or
 - The adjacent property redevelops, or
 - As part of roadway improvement project that adds capacity or a median to CO 83.
 - b. The existing access (#23) would eventually be closed. The project team went on to explain that this closure would only occur if
 - A cross access easement is obtained with adjacent properties, and
 - Internal connectivity to/from the access #22 or access #25 is developed.

3. Justin expressed concern about:
 - a. Traffic has significantly increased due to I-25 construction.
 - The project team indicated that the hope was for traffic volumes to reduce some when the construction was completed; however, there is development planned along CO 83 which will likely result in a future increase in traffic.
 - b. He indicated that he has spent a lot of time and money to upgrade his property.
 - The team explained that the recommendations in the final plan should help him plan for additional upgrades should he continue to improve his property.
 - c. He asked if there is a specific width of land, he should plan on reserving along the east edge of his property, if the highway was to be widened. He mentioned he would like to redo his entrance with a gate and other security devices, and he would like to not have to redo this work if the highway is widened.
 - The project team informed him that it was too early to really say. Typically, on a straight section of road any highway project would try to widen equally to both sides, but the amount of widening would be determined at the time of the highway improvement project.
 - The project team suggested he consider placing the gate at least as far back as the longest vehicle he plans to use on his property, plus some a little more distance for safety.
 - d. He asked about the triggers that would cause possible changes to his access.
 - He was informed that the most likely triggers would be traffic crashes, or operational issues that occur on Highway 83.
 - e. He asked about possible impact caused by the new school at Old Highway 105.
 - The team described how that project did complete a traffic study, which showed that traffic would not cause a problem. The site was designed based upon the results of the traffic to study to include a traffic signal, additional turn lanes, and other improvements.
 - f. He asked what triggers would allow the County to force him to do an easement with adjacent properties so he could gain access elsewhere.
 - He was informed that the County, nor CDOT, would force him to do an easement if he does not change his land use, but if he did redevelop then he might be forced to do so as part of the redevelopment.
 - g. The project team provided him with contact information to CDOT staff for CO 83 questions and to El Paso County staff for planning or road construction questions.
 - h. He mentioned he was very happy with meeting, felt at ease about the plan, and indicated we had answered all of his questions.
 - He asked that the team keep him informed of any up upcoming virtual meetings.

The project team hopes that you agree with our summary of your meeting and the key discussion points.

Based on our discussion with you, we have reconsidered the CO 83 access conditions near your property and have made changes to the plan. At this time, we anticipate the final access control plan documentation will include the following recommendations and conditions for future access changes that may impact you (see **Proposed Final Access Conditions Figure** on the next page).

- Access #25, Kaessner Lane, will remain open as a full movement access to CO 83 and may be signalized should the traffic volumes satisfy a signal warrant.
- Access #22 will be closed.

Should you have any questions regarding this letter, please contact me by phone at 303-221-7275 (or by email at david.sprague@atkinsglobal.com). Once again, I would like to thank you for participating in the project.

Proposed Final Access Conditions Figure

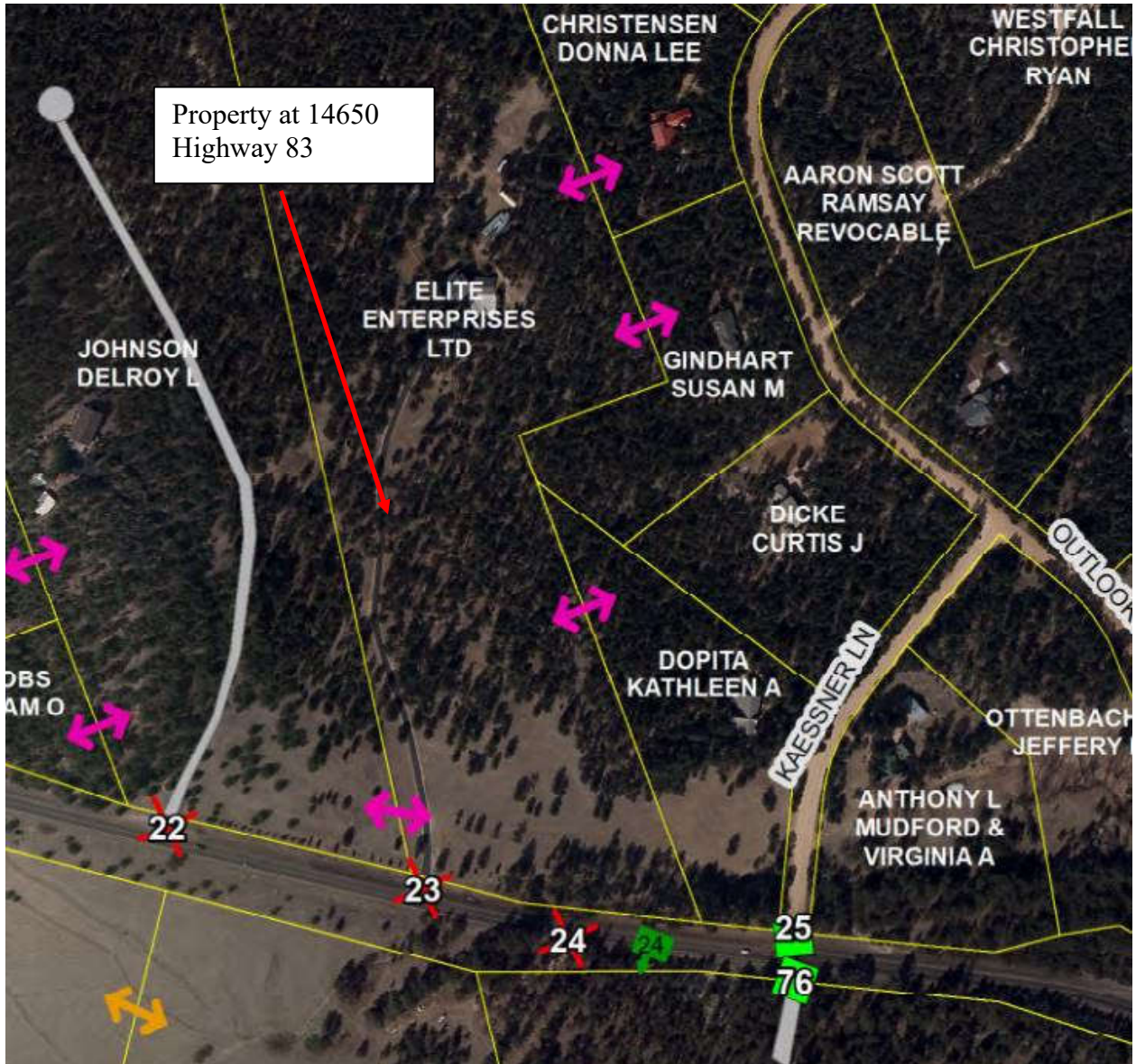

Sincerely,

David J. Sprague, PE
Atkins North America, Inc.
Consultant Project Manager

CC: Valerie Vigil, CDOT
Victoria Chavez, El Paso County
Todd Frisbie, City of Colorado Springs

Existing Access Conditions Figure



Legend

- Milepoints
- Full Movement (Unsignalized)
- ✗ Access Closed
- Full Movement (Signalized)
- Access Needing Research

CO-83 Access Control Plan
Page 5 of 14

0 200 400 800 Feet



COLORADO
 Department of Transportation
 Region 2



July 7, 2021

Delroy Johnson
 14502 Highway 83
 Colorado Springs, CO 80921

**RE: Property at 14502 Highway 83
 CO 83 Access Study
 Summary of One-on-One Meeting**

Dear Delroy:

On behalf of the entire project team, including El Paso County, the City of Colorado Springs, and the Colorado Department of Transportation (CDOT), I would like to thank you for participating in the on-going CO 83 Access Study. The success of the study depends on public involvement and input. On April 27, 2021, you participated in a one-on-one meeting with representatives from the project team to discuss access to your property at 14502 Highway 83. The following individuals were present at this meeting:

- Delroy Johnson, Property Owner
- Victoria Chavez, El Paso County
- Michelle Regalado, CDOT
- Valerie Vigil, CDOT
- David Sprague, Atkins
- Anna Ericson, Atkins

At your meeting, you were provided the opportunity to listen as the project team described the purpose of the study and provided details regarding the current and future access conditions that may have a direct impact to your property. During the meeting, you provided valuable input, which will be taken into consideration as final recommendations are made and the study is completed. The following is a brief summary of the key discussion items and/or decisions that occurred during your meeting:

1. The property of interest (14502 Highway 83) is located west of CO 83 (see **Existing Access Conditions Figure** attached to this letter). The property currently has a full movement access to CO 83 (#22).
2. The project team explained the draft plan recommendations to Delroy.
 - a. The existing access (#22) would remain as a full movement access and could be signalized in the future if the intersection was to satisfy a traffic signal warrant.
3. Delroy expressed concerns about:
 - a. He mentioned that because of this project he had stopped his redevelopment process because of the plan showing a connection out the west side of his property to Old Lasso Point. He indicated that he would not proceed if this easement is allowed. He explained that he wants to have a private driveway and keep it that way. He views his property as a single 28-acre lot that will allow his children to build homes in the area. His access will be a gated driveway, with updated security systems, and he will not allow it to be a shared access by other properties.

- The project team explained that the easement out the back of his property was being considered in order to help maximize the number of properties that could gain access to a full movement intersection, which was his driveway.
 - The project team explained that the draft plan includes closing or restricting most of the access points on either side of his property and since his driveway was being shown as a full movement, the recommendations in the plan were attempting to provide access to this full movement location for as many adjacent properties as possible.
- b. He indicated he was wondering if the plan could consider a frontage road from his driveway to Old Lasso Point and then maybe a frontage road from Old Lasso Point to Old North Gate.
- CDOT indicated they did not want him to stop his plans and the team would reevaluate this section of the plan.
 - The team indicated that it was possible to consider frontage roads, where the topography would allow them.
- c. Delroy asked about the time frame for changes to access.
- The team conveyed that the plan was a long-range vision for the highway but there are not planned projects in the near future that would alter the access near his property.
 - The team further explained that unfortunately there was not a time frame that could be placed on when, or even if, the changes to access would occur.
 - CDOT explained that as a result of his request for a sub-division of his property that CDOT may request a change to his access based on our plan, but this was not anticipated at this time
 - The team indicated they would update the plan and respond to him regarding any changes to the recommendations that may impact his access.

The project team hopes that you agree with our summary of your meeting and the key discussion points.

Based on our discussion with you, we have reconsidered the CO 83 access conditions near your property and have made changes to the plan. At this time, we anticipate the final access control plan documentation will include the following recommendations and conditions for future access changes that may impact you (see **Proposed Final Access Conditions Figure** on the next page).

- The recommended roadway connection out the west side of your property has been removed.
- However, the plan must consider the possibility that at some time in the future it may be in your, or the future owner of the property, best interest to consider connection to Old Lasso Point.
- The full movement signalized intersection will no longer be located at your driveway, but will be moved to Kaessner Lane.
- If a future frontage road could be provided between your property and Kaessner Lane, then your access would be closed, and you would gain access to/from CO 83 at Kaessner Lane (#25).

Proposed Final Access Conditions Figure

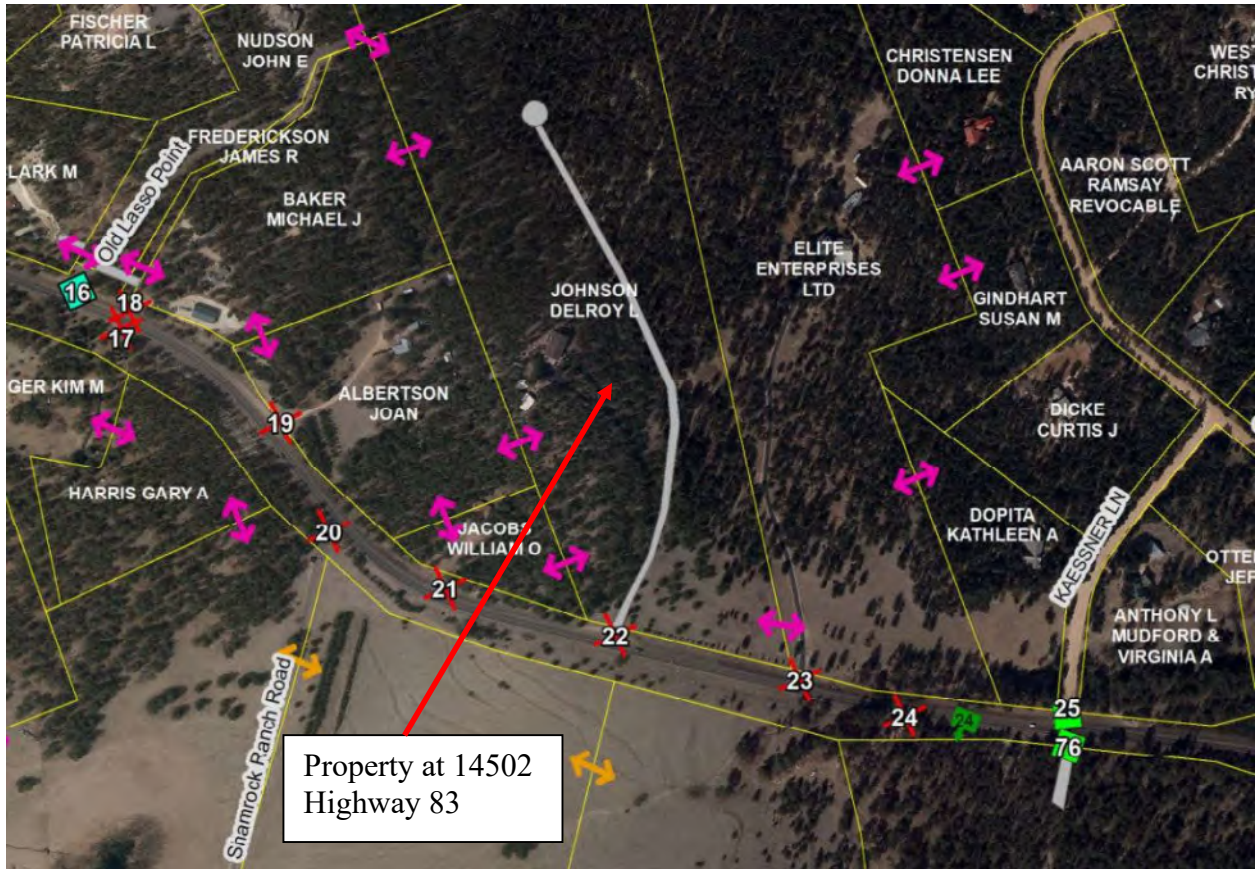

Should you have any questions regarding this letter, please contact me by phone at 303-221-7275 (or by email at david.sprague@atkinsglobal.com). Once again, I would like to thank you for participating in the project.

Sincerely,







David J. Sprague, PE
Atkins North America, Inc.
Consultant Project Manager

CC: Valerie Vigil, CDOT
Victoria Chavez, El Paso County
Todd Frisbie, City of Colorado Springs

Existing Access Conditions Figure



Legend

-  Milepoints
-  Parcels
-  Full Movement (Signalized)
-  Full Movement (Unsignalized)
-  Access Needing Research
-  Access Closed

CO-83 Access Control Plan

Page 5 of 14

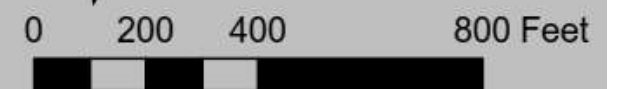



July 7, 2021

Kim and Chuck Kruger
Ann and Gary Harris
14405 Highway 83
Colorado Springs, CO 80921

**RE: Property at 14405 Highway 83
CO 83 Access Study
Summary of One-on-One Meeting**

Dear Kim and Chuck:

On behalf of the entire project team, including El Paso County, the City of Colorado Springs, and the Colorado Department of Transportation (CDOT), I would like to thank you for participating in the on-going CO 83 Access Study. The success of the study depends on public involvement and input. On April 22, 2021, you participated in a one-on-one meeting with representatives from the project team to discuss access to your property at 14405 Highway 83. Ann and Gary Harris have a property just to the north of the Kruger's and they share the same access point to CO 83. The following individuals were present at this meeting:

- Kim Kruger, Property Owner
- Chuck Kruger, Property Owner
- Ann Harris, Property Owner
- Gary Harris, Property Owner
- Victoria Chavez, El Paso County
- Jennifer Irvine, El Paso County
- Valerie Vigil, CDOT
- David Sprague, Atkins
- Anna Ericson, Atkins

At your meeting, you were provided the opportunity to listen as the project team described the purpose of the study and provided details regarding the current and future access conditions that may have a direct impact to your property. During the meeting, you provided valuable input, which will be taken into consideration as final recommendations are made and the study is completed. The following is a brief summary of the key discussion items and/or decisions that occurred during your meeting:

1. The property of interest (14405 Highway 83) is located east of CO 83 (see **Existing Access Conditions Figure** attached to this letter). The property currently has a full movement access to CO 83 (#17).
2. The project team explained the draft plan recommendations to the property owners.
 - a. The existing access (#17) could be restricted to a to less than a full movement access (see **Proposed Access Conditions Figure** attached to this letter). The access may be restricted to right-in, right-out or $\frac{3}{4}$ movement if adequate improvements have been made to ensure U-turns can be safely completed at nearby intersections, and
 - An operational and/or safety issues are identified through the completion of a traffic study; or
 - The adjacent property redevelops, or
 - As part of roadway improvement project that adds capacity or a median to CO 83.

- b. The existing access (#17) would eventually be closed. The project team went on to explain that this closure would only occur if
 - A cross access easement is obtained with adjacent properties, and
 - Internal connectivity to/from access #13 and/or proposed access #76 (re-development of Shamrock Ranch) is developed.

- 3. The Kruger and Harris families expressed concern about:
 - a. The families indicated they did not want to lose property value if their driveway is closed. Also, they wanted to know how they were supposed to get to the next access if it required going across other properties. They also indicated it was no possible to go out the east side of their property due to topography and grade issues.
 - The project team informed them:
 - That the plan is a long-range vision for the highway but there are currently no planned projects that would alter the access to the properties.
 - If the property owners do not make a change to their land use or redevelop, then their driveways will likely stay exactly as it is today with no changes.
 - If the property next to them redeveloped, it may be in their best interest to see if they could relocate their access to a location that would still provide them access to a full movement intersection that may in the future be controlled by a traffic signal.
 - b. They do not see any accident problems and would like to see if there was something that could be done about speeding and to remove trucks from the roadway.
 - The project team informed them that these are legitimate concerns, but they were outside the scope of the current project.
 - c. Asked about the process should there be a change to their access or the need for them to give away from right of way.
 - The project team explained that CDOT notifies them of the project and the conditions of the changes. CDOT is required to provide 30-day notification, but it could be up to 60-days. Any need for right of way, for highway widening or other improvements, would result in them being fairly compensated.
 - d. They described what they felt was a lack of proper maintenance on the curve near their driveway that has resulted in flat tires and crashes in the area.
 - The team informed them to please contact CDOT Customer Service line 719-562-5568 regarding their concerns on the maintenance issues.

The project team hopes that you agree with our summary of your meeting and the key discussion points. Based on our discussion with you, we have reconsidered the CO 83 access conditions near your property. At this time, we anticipate the final access control plan documentation will not change from what was shown in the draft plan.

Should you have any questions regarding this letter, please contact me by phone at 303-221-7275 (or by email at david.sprague@atkinsglobal.com). Once again, I would like to thank you for participating in the project.

Sincerely,



David J. Sprague, PE
Atkins North America, Inc.
Consultant Project Manager

CC: Valerie Vigil, CDOT
Victoria Chavez, El Paso County
Todd Frisbie, City of Colorado Springs

Existing Access Conditions Figure



Legend			CO-83 Access Control Plan		
	Milepoints		Full Movement (Signalized)		Access Needing Research
	Parcels		Full Movement (Unsignalized)		Access Closed

Page 5 of 14





July 7, 2021

Anthony Peterson
2725 Rustic Oak Grove
Colorado Springs, CO 80921

**RE: Property at 2725 Rustic Oak Grove
CO 83 Access Study
Summary of One-on-One Meeting**

Dear Anthony:

On behalf of the entire project team, including El Paso County, the City of Colorado Springs, and the Colorado Department of Transportation (CDOT), I would like to thank you for participating in the on-going CO 83 Access Study. The success of the study depends on public involvement and input. On April 20, 2021, you participated in a one-on-one meeting with representatives from the project team to discuss access to your property at 2725 Rustic Oak Grove. The following individuals were present at this meeting:

- Anthony Peterson, Property Owner
- Victoria Chavez, El Paso County
- Valerie Vigil, CDOT
- David Sprague, Atkins
- Anna Ericson, Atkins

At your meeting, you were provided the opportunity to listen as the project team described the purpose of the study and provided details regarding the current and future access conditions that may have a direct impact to your property. During the meeting, you provided valuable input, which will be taken into consideration as final recommendations are made and the study is completed. The following is a brief summary of the key discussion items and/or decisions that occurred during your meeting:

1. The property of interest (2725 Rustic Oak Grove) is located west of CO 83 (see **Existing Access Conditions Figure** attached to this letter). The property currently has a full movement access to CO 83 (#14).
2. The project team explained the draft plan recommendations to Anthony.
 - a. The existing access (#14) could be restricted to a to less than a full movement access. The access may be restricted to right-in, right-out or ¾ movement if adequate improvements have been made to ensure U-turns can be safely completed at nearby intersections, and
 - An operational and/or safety issues are identified through the completion of a traffic study; or
 - The adjacent property redevelops, or
 - As part of roadway improvement project that adds capacity or a median to CO 83.
 - b. The existing access (#14) may eventually be closed. The project team went on to explain that this closure would only occur if
 - A cross access easement is obtained with adjacent properties, and

- Internal connectivity to/from access #12 or access #16 is developed.
3. Anthony expressed concern about:
- a. He was concerned about trying to gain access out the west side of his property due to the difficult topography and grades. He was more in favor of looking at a frontage road along CO 83 that would allow him to have access to Old Lasso or Old North Gate. He informed the team that there is a cell tower on his property and large vehicles need access to the tower area.
 - The project team informed him that one of the reasons for having these meetings was to allow the property owners to express their concerns and talk about things like grade and topography. The team will take Anthony's concerns and comments into consideration before making any final recommendations for changes at his access.
 - b. He asked if it was possible for a center turn lane to be added to CO 83 between Old north Gate to Old Lasso Point.
 - The project team informed him that there were no planned improvement projects for CO 83 at this time. However, the team indicated that should a project occur, the addition of a center turn lane could be evaluated as a possible enhancement to CO 83.
 - The team discussed how the access study was looking more long term for solutions that would benefit operations and safety on CO 83, which included identifying where access points should be located and what types of access should be allowed. The team mentioned that it was unlikely that his access would change in the near future, as long as he did not redevelop his property
 - He was assured that there would be no surprise changes to access along CO 83. CDOT would provide him with plenty of notice and allow him to have time to discuss changes with CDOT during any future projects along the highway.
 - The team assured him that his property must be provided with reasonable access at all time, thus, any change in access would not land lock is property. All changes to the highway would involve a public process that he would be notified of and allowed ample time to participate.

The project team hopes that you agree with our summary of your meeting and the key discussion points. Based on our discussion with you, we have reconsidered the CO 83 access conditions near your property. At this time, we anticipate the final access control plan documentation will include the following recommendations and conditions for future access changes that may impact you (see **Proposed Final Access Conditions Figure** on the next page).

- Old Lasso Point will be a ¾-movement access (no lefts out) instead of a right-in, right-out.
- Future access from the west side of your property has been removed.

Proposed Final Access Conditions Figure

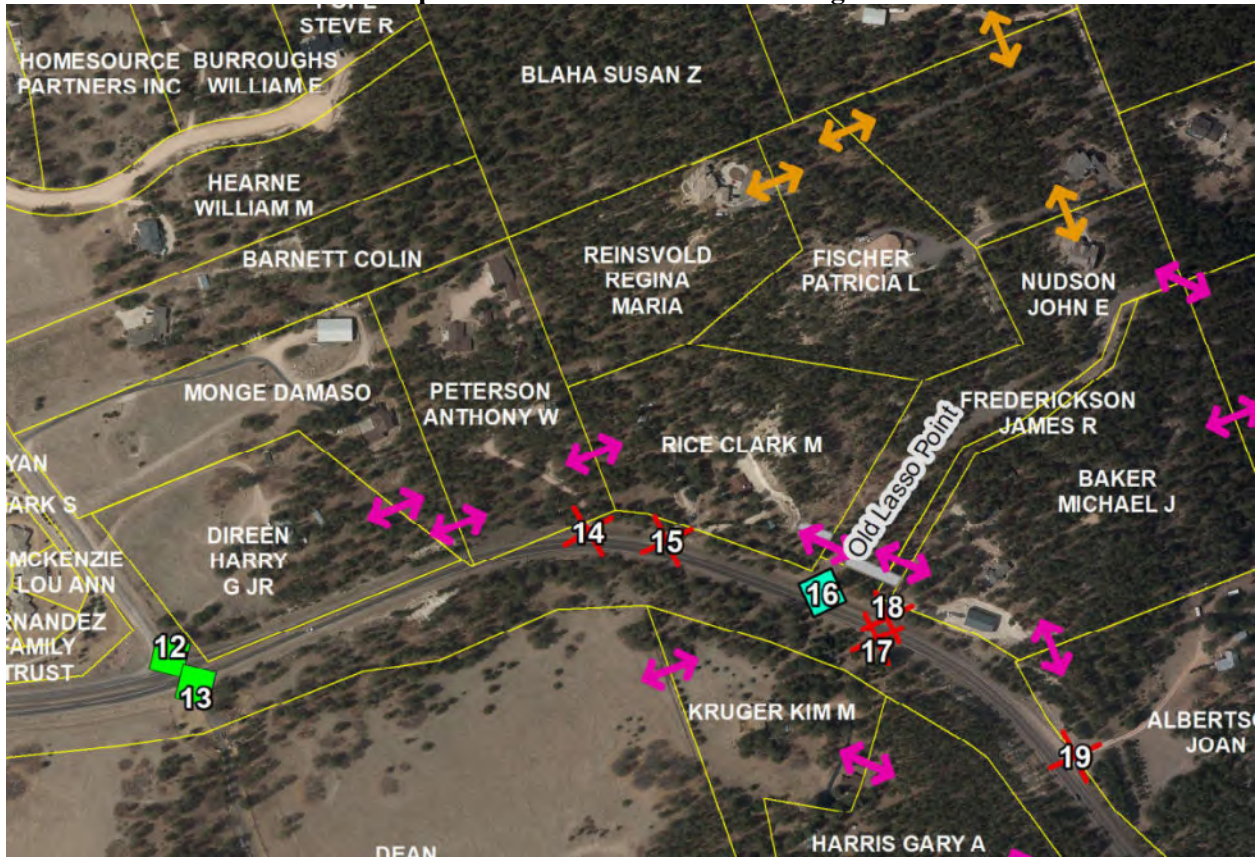

Should you have any questions regarding this letter, please contact me by phone at 303-221-7275 (or by email at david.sprague@atkinsglobal.com). Once again, I would like to thank you for participating in the project.

Sincerely,

David J. Sprague, PE
Atkins North America, Inc.
Consultant Project Manager

CC: Valerie Vigil, CDOT
Victoria Chavez, El Paso County
Todd Frisbie, City of Colorado Springs

Existing Access Conditions Figure



Legend

	Milepoints		Full Movement (Signalized)		Access Needing Research
	Parcels		Full Movement (Unsignalized)		Access Closed

CO-83 Access Control Plan
 Page 5 of 14

 0 200 400 800 Feet



July 7, 2021

Andy Stauffer
3220 Outlook Drive
Colorado Springs, CO 80921

**RE: Property at 3220 Outlook Drive
CO 83 Access Study
Summary of One-on-One Meeting**

Dear Andy:

On behalf of the entire project team, including El Paso County, the City of Colorado Springs, and the Colorado Department of Transportation (CDOT), I would like to thank you for participating in the on-going CO 83 Access Study. The success of the study depends on public involvement and input. On April 15, 2021, you participated in a one-on-one meeting with representatives from the project team to discuss access to your property at 3220 Outlook Drive. The following individuals were present at this meeting:

- Andy Stauffer, Property Owner
- Victoria Chavez, El Paso County
- Jennifer Irvine, El Paso County
- Valerie Vigil, CDOT
- David Sprague, Atkins
- Anne Ericson, Atkins

At your meeting, you were provided the opportunity to listen as the project team described the purpose of the study and provided details regarding the current and future access conditions that may have a direct impact to your property. During the meeting, you provided valuable input, which will be taken into consideration as final recommendations are made and the study is completed. The following is a brief summary of the key discussion items and/or decisions that occurred during your meeting:

1. The property of interest (3220 Outlook Drive) is located west of CO 83 (see **Existing Access Conditions Figure** attached to this letter). The property currently accesses CO 83 via Kaessner Lane, a full movement access to CO 83 (#25).
2. The project team explained the draft plan recommendations to Andy.
 - a. The existing access (#25) could be restricted to a to less than a full movement access. The access may be restricted to right-in, right-out or ¾ movement if adequate improvements have been made to ensure U-turns can be safely completed at nearby intersections, and
 - An operational and/or safety issues are identified through the completion of a traffic study; or
 - The adjacent property redevelops, or
 - As part of roadway improvement project that adds capacity or a median to CO 83, or
 - A traffic signal is warranted.

Proposed Final Access Conditions Figure



Should you have any questions regarding this letter, please contact me by phone at 303-221-7275 (or by email at david.sprague@atkinsglobal.com). Once again, I would like to thank you for participating in the project.

Sincerely,

David J. Sprague, PE
Atkins North America, Inc.
Consultant Project Manager

CC: Valerie Vigil, CDOT
Victoria Chavez, El Paso County
Todd Frisbie, City of Colorado Springs

Existing Access Conditions Figure

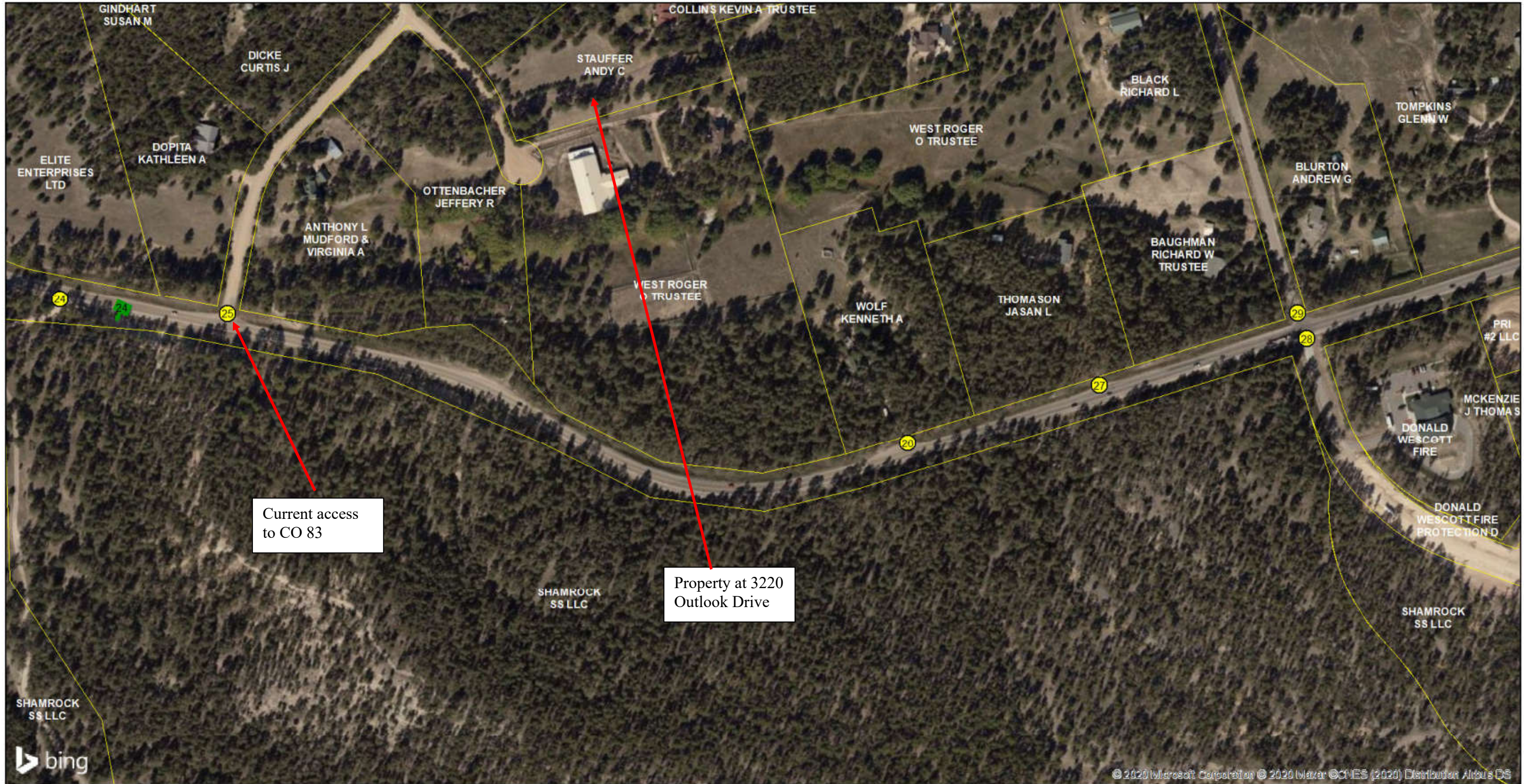

Legend			CO-83 Access Control Plan		
	Milepoints		Full Movement (Signalized)		Access Needing Research
	Parcels		Full Movement (Unsignalized)		Access Closed

Page 6 of 14

0 200 400 800 Feet



July 7, 2021

Ken Wolf
15040 Highway 83
Colorado Springs, CO 80921

**RE: Property at 15040 Highway 83
CO 83 Access Study
Summary of One-on-One Meeting**

Dear Ken:

On behalf of the entire project team, including El Paso County, the City of Colorado Springs, and the Colorado Department of Transportation (CDOT), I would like to thank you for participating in the on-going CO 83 Access Study. The success of the study depends on public involvement and input. On May 17, 2021, you participated in a one-on-one meeting with representatives from the project team to discuss access to your property at 15040 Highway 83. The following individuals were present at this meeting:

- Ken Wolf, Property Owner
- Victoria Chavez, El Paso County
- Jennifer Irvine, El Paso County
- Valerie Vigil, CDOT
- Arthur Gonzales, CDOT
- Michelle Regalado, CDOT
- David Sprague, Atkins
- Anna Ericson, Atkins

At your meeting, you were provided the opportunity to listen as the project team described the purpose of the study and provided details regarding the current and future access conditions that may have a direct impact to your property. During the meeting, you provided valuable input, which will be taken into consideration as final recommendations are made and the study is completed. The following is a brief summary of the key discussion items and/or decisions that occurred during your meeting:

1. The property of interest (15040 Highway 83) is located west of CO 83 (see **Existing Access Conditions Figure** attached to this letter). The property currently has a full movement access to CO 83 (#26).
2. The project team explained the draft plan recommendations to Andy.
 - a. The existing access (#26) could be restricted to a to less than a full movement access. The access may be restricted to right-in, right-out or ¾ movement if adequate improvements have been made to ensure U-turns can be safely completed at nearby intersections, and
 - An operational and/or safety issues are identified through the completion of a traffic study; or
 - The adjacent property redevelops, or
 - As part of roadway improvement project that adds capacity or a median to CO 83.

- b. The existing access (#26) may eventually be closed. The project team went on to explain that this closure would only occur if
 - A cross access easement is obtained with adjacent properties, and
 - Internal connectivity to/from the access #29 is developed.
3. Ken expressed concern about:
 - a. The highway was a country road when he moved in, then growth occurred directly off of Highway 83 to the north and south of his property. As a result, the increase in volumes, especially commercial vehicles, have created what he believes is a dangerous condition. He feels the GAP project has increased the traffic on Highway 83, which it was not intended to accommodate. He also said that incidents on I-25 result in additional traffic growth on Highway 83.
 - The team explained that the highway is a public road and the number of vehicles using this highway cannot be limited or controlled.
 - b. The commercial vehicles use engine brakes to slow down going southbound. They seem to start using the brakes right at his driveway and they are very loud. He understands that the brakes help the trucks slow down to make the curve south of his drive. He also mentioned that for northbound trucks, going uphill, the truck engines are very loud as they are headed toward Flying Horse and developments further north. The highway noise has grown so bad that it impacts his property.
 - The team mentioned the laws that govern the use of truck brakes and shared information from the State Patrol on the matter with Ken.
 - The team mentioned that the current study has a limited scope to look at access points and how they connect to the highway and would not be addressing noise issues or concerns at this time.
 - c. He is concerned about all the development and growth at Stagecoach east of the highway. The new merge lane that was recently installed causes all the southbound traffic to merge directly in front of his driveway. The southbound shoulder also now ends directly in front of his driveway. He feels that the improvements in the area only help the new development and actually make it worse for him.
 - CDOT does not approve development or growth, that is done at the County level.
 - The County indicated that all development along the highway must go through their approved process, which includes a traffic impact analysis to identify possible improvements or mitigation measures that are needed.
 - d. He mentioned that in his opinion there have not been any improvements to the highway in 30-years aimed at helping the people who live along the highway. The only improvements he has seen are at intersections due to additional development that has occurred recently. He feels that the County and CDOT have allowed the developers to do the minimal amount improvements and not what was right. As a result, he is very concerned about the safety of his family attempting to turn into his driveway, which is right at the point where the shoulder and the merge lane ends. The minimal requirements create a dangerous condition for his family and those coming out of Stagecoach because only the minimal requirements were followed.
 - County indicated that it has design criteria and standards that are required to be used by the developers, and that all projects on the highway must meet the State and County criteria. The standards do set minimal criteria and often times developers will do exactly that, the minimal to satisfy the criteria. By having the minimal criteria in the design standards, it at least holds developers and all projects to some kind of standard and tries to create the safest possible highway design.

- The team mentioned that it is possible that a future signal at Stagecoach, just north of his access, would help slow vehicles and make gaps in the traffic stream to allow safer entry to the highway.
- The team committed to looking at striping in the area to see if there is something that could be done to improve his condition. This may include the need for some widening to improve the shoulder or merge area.

The project team hopes that you agree with our summary of your meeting and the key discussion points. Based on our discussion with you, we have reconsidered the CO 83 access conditions near your property. At this time, we anticipate the final access control plan documentation will not change from what was shown in the draft plan.

Should you have any questions regarding this letter, please contact me by phone at 303-221-7275 (or by email at david.sprague@atkinsglobal.com). Once again, I would like to thank you for participating in the project.

Sincerely,





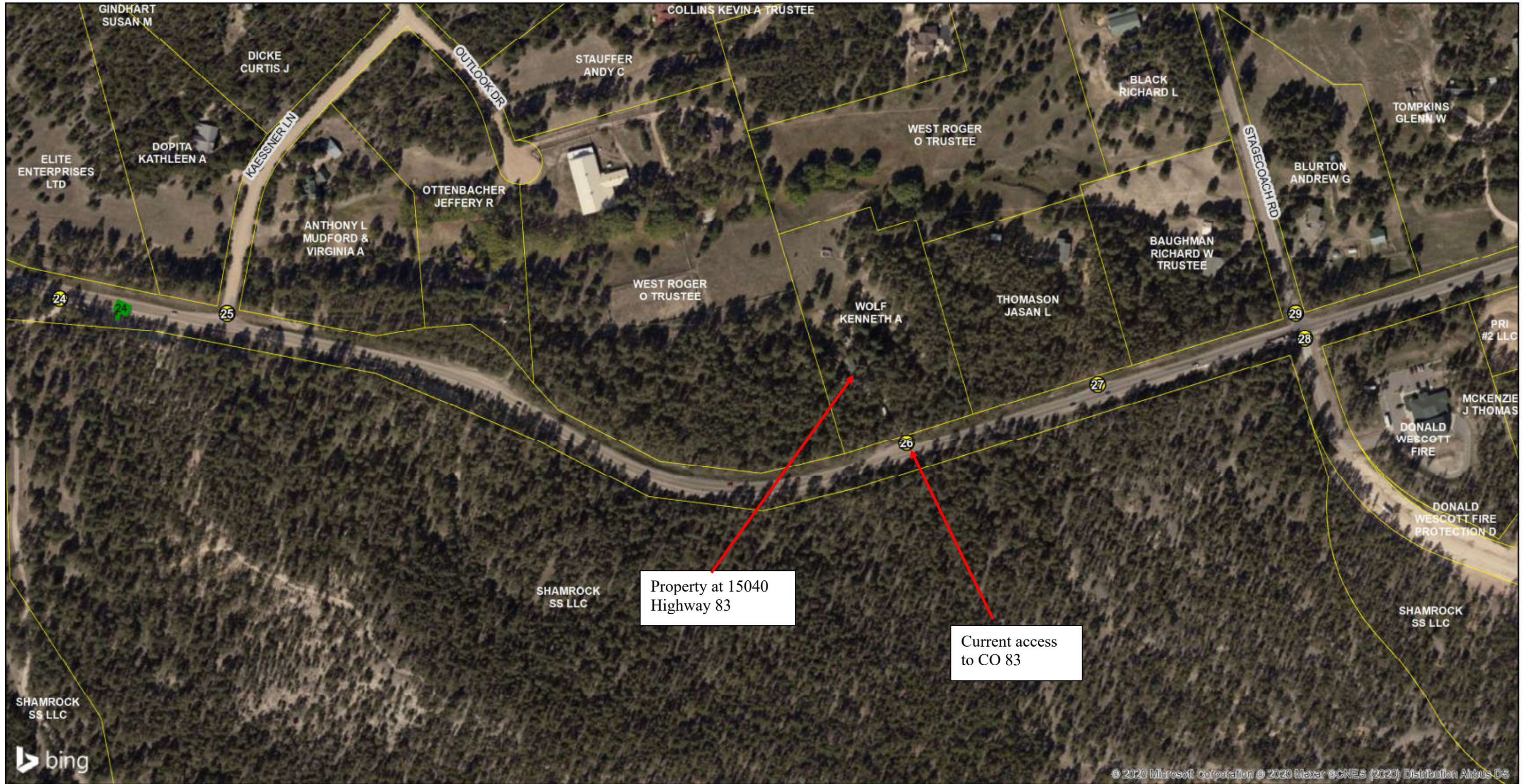

David J. Sprague, PE
Atkins North America, Inc.
Consultant Project Manager

CC: Valerie Vigil, CDOT
Victoria Chavez, El Paso County
Todd Frisbie, City of Colorado Springs

Existing Access Conditions Figure



Legend

-  Milepoints
-  Full Movement (Signalized)
-  Access Needing Research
-  Parcels
-  Full Movement (Unsignalized)
-  Access Closed

CO-83 Access Control Plan



E.3. Open House #2 Materials



COLORADO
Department of Transportation

WELCOME

to the

**CO 83 Access
Study**

**Final
Virtual Open House**





COLORADO

Department of Transportation

CO 83 ACCESS STUDY



GENERAL INFORMATION



VIRTUAL MEETING FORMAT

- Please take your time and review the materials at each station within the virtual meeting room.
- The maps at the Recommendations station are arranged from Powers Boulevard going toward County Line Road to better help you find a driveway/access location.
- We ask that you refer to the access numbers on the maps when asking questions or providing comments. For example, if you have an interest in the recommendations shown for access #34 on the maps, then please reference this number on your comment form that can be found at the Closing station.
- A member of the project team will respond to your comments in a timely manner and may reach out to you for clarifications.
- The open house is intended to be a self-paced review of project information, so there is no formal presentation by the project team.
- If you visited the first CO 83 ACP Open House in March/April 2021, much of the information in this Open House is the same, with the exception of the “Final Access Study Recommendations “ boards

FAQs FREQUENTLY ASKED QUESTIONS

○ **When can you expect changes in access to occur on CO 83?**

Currently, there are no plans to make any changes to access within the study area.

Changes will occur incrementally over time when the following occurs:

- A problem with traffic flow or safety is identified.
- Properties redevelop or change their existing land use.
- Funding for a roadway project is obtained, but at this time such funding does not exist.

In short, most changes will not occur in the near future and some of the changes may never occur if the conditions mentioned above are not satisfied (more information on this topic can be found at the Access Study Process station).

○ **Will the study recommend changing speed limits?**

No, making a change to a speed limit is not a recommendation of an access study.

Changes in speed limits are the result of a traffic study that evaluates the travel speed of vehicles using the highway and then recommends the proper speed limit for that portion of roadway.

○ **How much will the recommendations cost?**

The access study does not evaluate the cost of the proposed changes.

The cost of changes will vary from location to location based on the final design of the roadway, driveway, and intersection features, including number of lanes, the need for a traffic signal, and other roadway improvements.

Because the changes will occur in phases over a long period of time, the total cost of all the recommendations shown in the study is unknown.

○ **Will the study recommend a change to the highway classification?**

All highways have a classification that determines many features, including where and when access is allowed, maximum speed limits, the need for turn lanes, and the distance between traffic signals. More information can be found in the Existing Access Conditions on station.

The access study is not recommending a change to the existing highway classification.

○ **Who do I talk to if I have a specific concern or issue related to the recommendations at my access location?**

You can complete a comment form with your questions/concerns and submit it to the project team, or you can reach out directly to Dave Sprague, Consultant, Project Manager at David.Sprague@atkinsglobal.com.

A project team member will contact you by email or phone to discuss your concerns.



COLORADO

Department of Transportation

CO 83 ACCESS STUDY

ACCESS STUDY OVERVIEW



ACCESS STUDY OVERVIEW

Study Area

- The study area is from Powers Boulevard (CO 21) to Palmer Divide Road/County Line Road, a distance of approximately 9.7 miles.

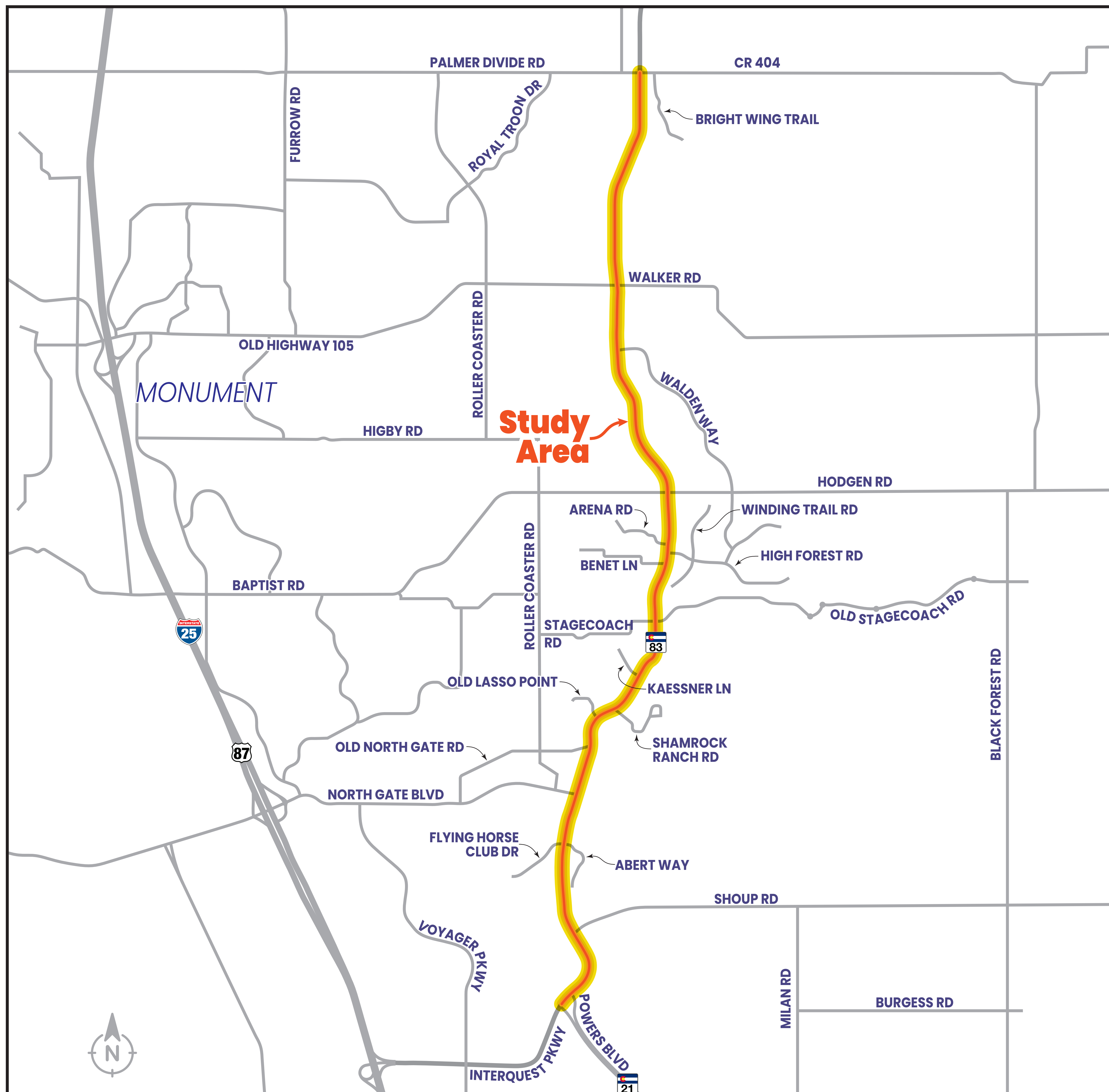

What is an Access Point?

- Any intersection or driveway along a roadway that crosses the right of way is called an access point.

ACCESS STUDY OVERVIEW

(CONTINUED)

What does an Access Study do?

- Evaluates how existing access points impact the operations and safety of vehicles, pedestrians, and bicyclists moving along and across CO 83
- Establishes a long-range vision (2045 and beyond) for access points along the highway
- Recommends future:
 - Access point locations
 - Traffic movements allowed at each access point
 - Type of intersection control (yield/stop sign or traffic signal) at each access point
- Ensures each abutting property has access either directly to CO 83 or via an adjacent local street
 - This includes identifying alternate access routes, such as future road connections or cross access opportunities between adjacent properties
- Does not determine the future number of lanes or design features of CO 83.

Why study Access Points?

- There is potential for a conflict to occur between the different modes of transportation (vehicle, pedestrian, and bicycle) at these locations.
- Vehicles turning into and out of access points can cause other vehicles to slow down, resulting in delay, congestion, or crashes.

CO 83 ACCESS STUDY OVERVIEW

(CONTINUED)

What are the goals of this Access Study?

- Identify improvements to the local transportation network that promote safety for all modes of transportation.
- Provide the appropriate level of access to properties adjacent to the highway.
- Support future development and redevelopment along CO 83.
- Provide efficient movement for all modes of transportation along and across CO 83.

Why do an Access Study on this portion of CO 83?

- Optimizing the number of access points on CO 83:
 - Reduces conflict points where a crash may occur. This is applicable not only for vehicles, but also for pedestrians and bicycles having to cross multiple access points along CO 83.
 - Creates fewer locations for vehicles to brake or turn onto or off the highway, resulting in more efficient travel for through traffic.
 - Makes the corridor more visually appealing to all users and visitors by reducing the number of driveways.

CO 83 ACCESS STUDY OVERVIEW

(CONTINUED)

Each access location is evaluated based on existing conditions, anticipated future traffic conditions, and potential for redevelopment of the adjacent parcels to make a long-range recommendation for optimizing access to CO 83.

Methods to Optimize Access

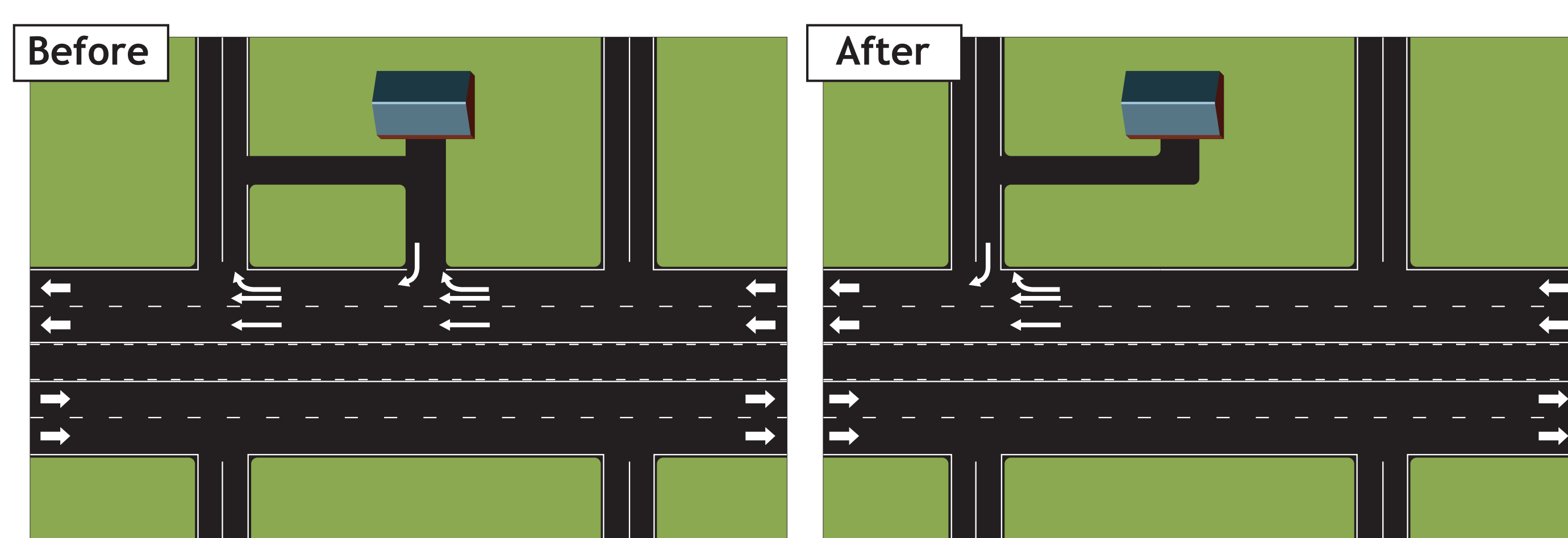

Use of Local Streets

- Provide access to local properties through secondary roads.
- Consolidate number of access locations where vehicles may enter or exit the highway.
- Reduce the number of conflict points.

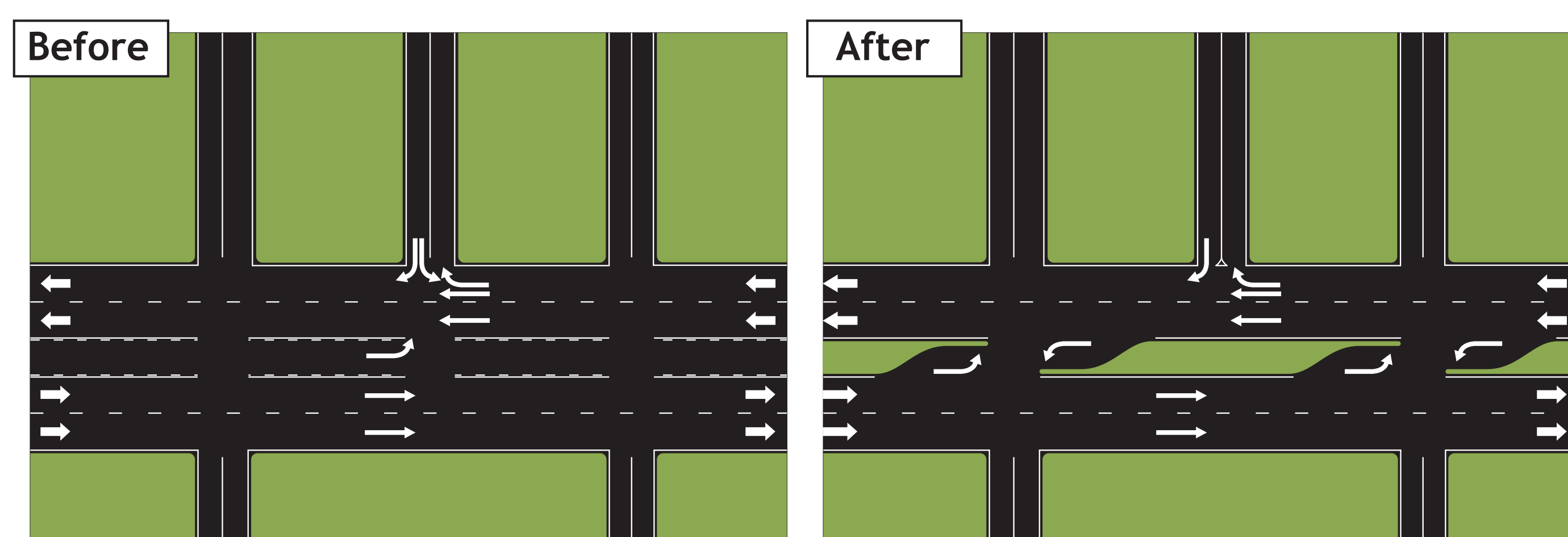

Addition of Median Treatment

- Limit turning movements to locations with a dedicated left-turn lane.
- Reduce the number of conflicts between left-turning vehicles and through vehicles on the highway.

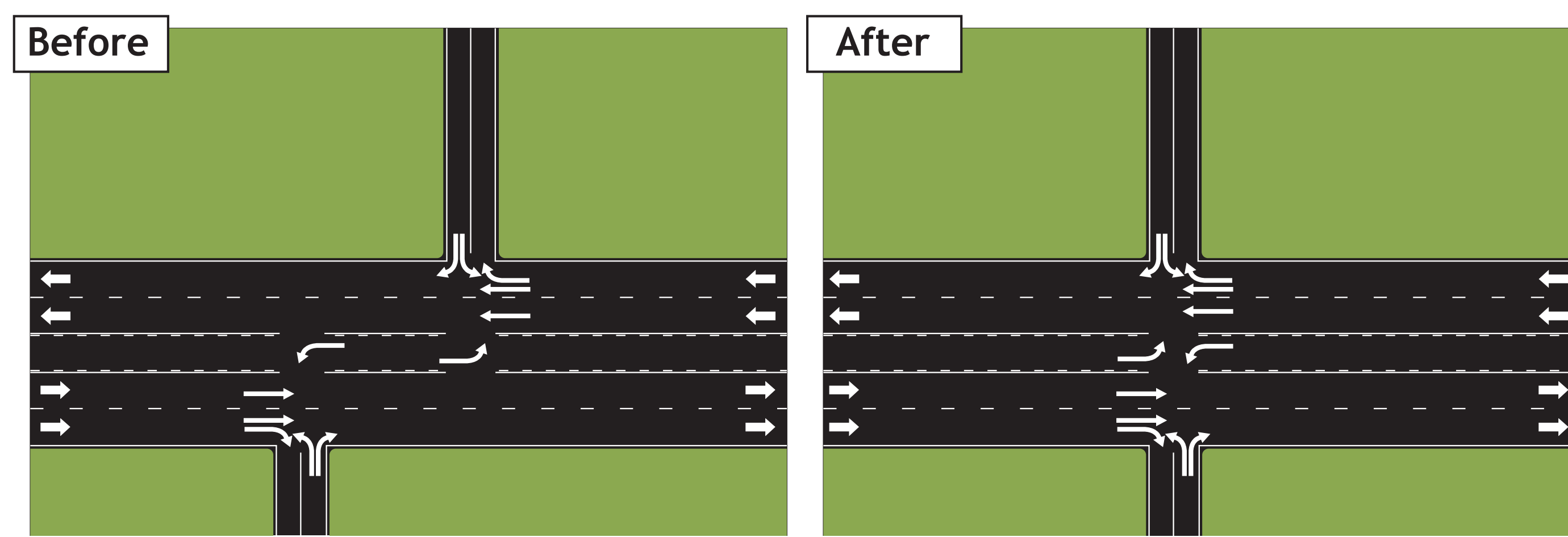

Realignment

- Align opposite approach.
- Create a more familiar intersection design.

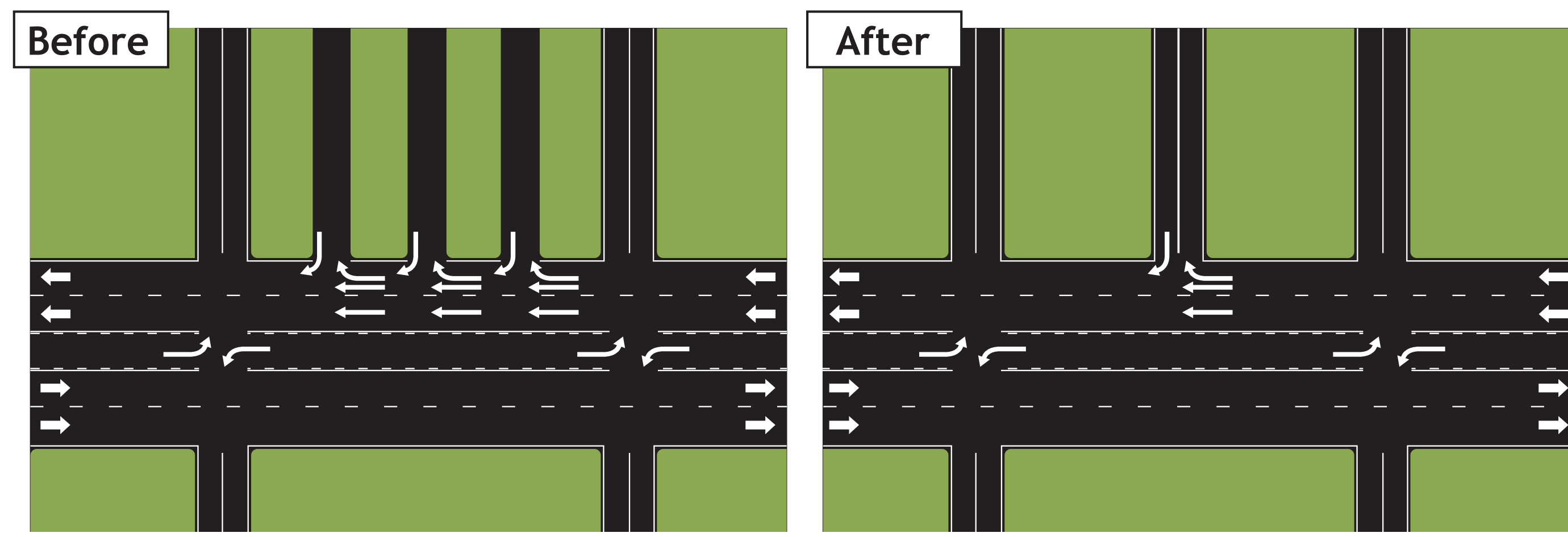

Consolidation

- Consolidate adjacent access points into fewer locations.
- Reduce the number of conflict points.

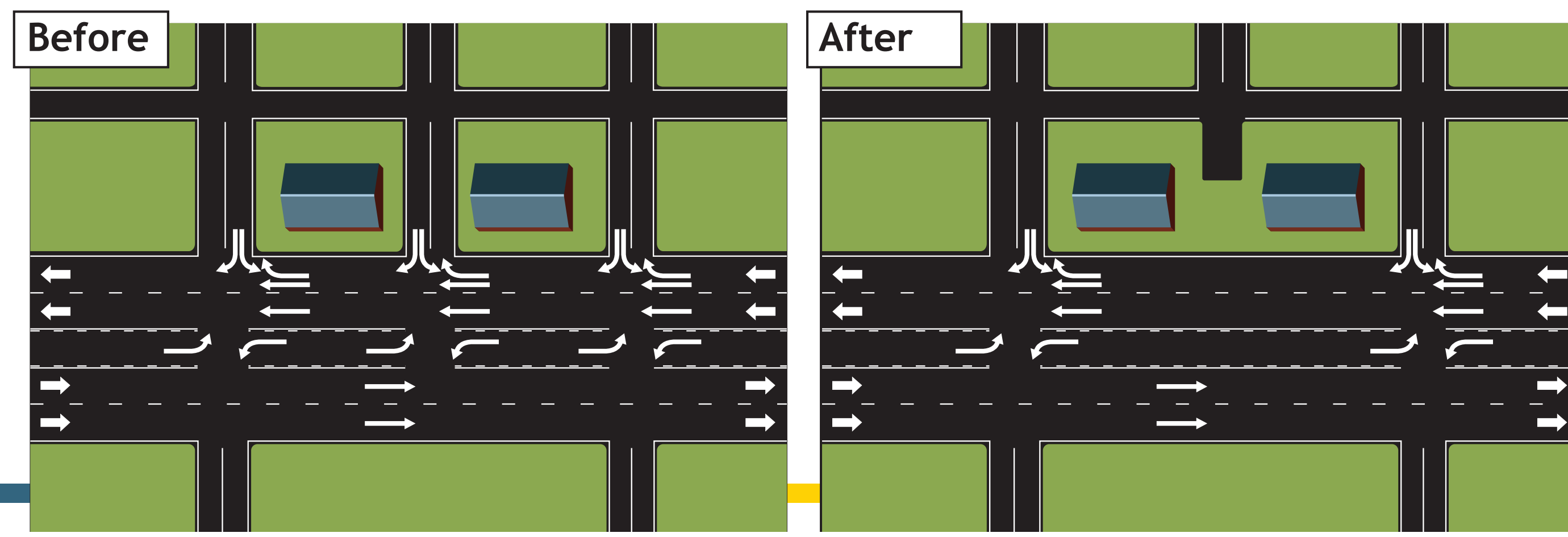

Alternate Access Route

- Provide access to properties via an improved/new alternate access road.
- Reduces the number of access points along the highway.



COLORADO

Department of Transportation

CO 83 ACCESS STUDY

ACCESS STUDY PROCESS



ACCESS STUDY PROCESS

Conduct the study

Propose improvements
based on study findings

Conduct Public Outreach

**WE
ARE
HERE**

Make Final Recommendation
based on input from public

Accept the recommendations

Prepare an Intergovernmental Agreement
between the City of Colorado Springs, El Paso County, and CDOT

Specify how the Access Study can be amended in the future,
if necessary

Sign the Intergovernmental Agreement
and adopt the recommendations

Report outcomes to the Colorado Transportation Commission
and get approval from the CDOT State Access Manager

**Continue coordination between
the City of Colorado Springs, El Paso County, and CDOT**
to ensure proper implementation of the plan in the future

ACCESS STUDY PROCESS

(CONTINUED)

When should you expect to see changes in access?

- This plan is a long-range vision (2045 and beyond) for the highway and will be implemented in phases.
- Changes to access on CO 83 will occur in phases or incrementally over time based on:
 - When a property, or series of adjacent properties, is redeveloped. The City, County, and CDOT will work with the developer to ensure the accesses are consistent with the recommendations of this study.
 - If the City, County, and/or CDOT perform a safety study (based on crash history) and identify a specific safety concern that could be improved by modifying an existing access point.
 - If the City, County, and/or CDOT complete a traffic study and identify a traffic flow and/or pedestrian/bicyclist movement that would benefit by making a change to the existing access points.
 - If the City, County, and/or CDOT identify a project, secure funding, and complete the necessary design processes to construct improvements that include modifying an existing access point.
- The City, County, and CDOT do not have any planned projects or identified funding that would close or make changes to any existing access points in the immediate future.



COLORADO

Department of Transportation

CO 83 ACCESS STUDY

EXISTING ACCESS CONDITIONS



EXISTING ACCESS CONDITIONS

SEGMENT 1: CO 83 from CO 21 (Powers Boulevard) to Old North Gate Road

- The segment is classified as an Expressway based on CDOT's State Highway Access Code.
- Expressways are intended to accommodate high traffic volumes at high travel speeds.
- Expressways prioritize movement of traffic over access to private property.
- If the property has access to a local road, direct access to the highway will be prohibited.
- Spacing between signalized full movement intersections is one mile, but half-mile spacing is acceptable if reasonable alternate access is not available.
- Existing Number and Types of Access in Segment 1:
 - Total of 12 access points in 2.75 miles
 - 3 private driveways and 9 public roads
 - All provide full-movement access and 5 intersections have traffic signals

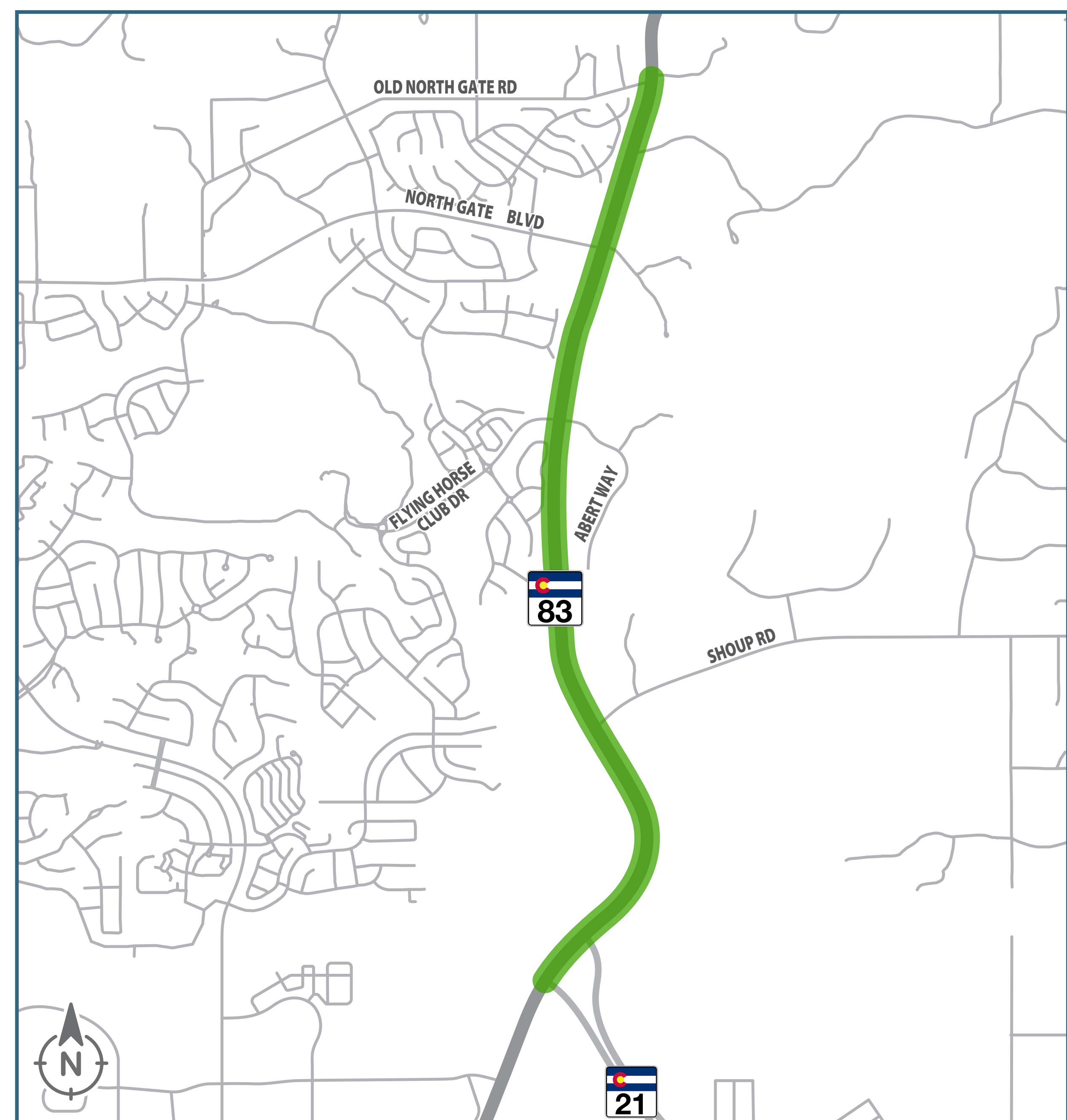

FOR MORE INFORMATION, REFER TO THE RECOMMENDATIONS STATION

EXISTING ACCESS CONDITIONS

(CONTINUED)

SEGMENT 2: CO 83 from Old North Gate Road to Old Highway 105/Walker Road

- This segment is classified as a Regional Highway based on CDOT's State Highway Access Code.
- Regional Highways are intended to accommodate medium to high traffic volumes at medium to high travel speeds.
- Regional Highways are intended to provide service to through traffic movements, with lower priority on providing direct access to adjacent properties.
- Access to adjacent properties should be achieved through use of the local streets whenever reasonable.
- Spacing between signalized full movement intersections of one-half mile is preferred.
- Existing Number and Types of Access in Segment 2:
 - 47 total access points in 5 miles
 - 36 private driveways/field accesses and 11 public roads
 - 46 provide full-movement access (one is right-in only) and two intersections have traffic signals

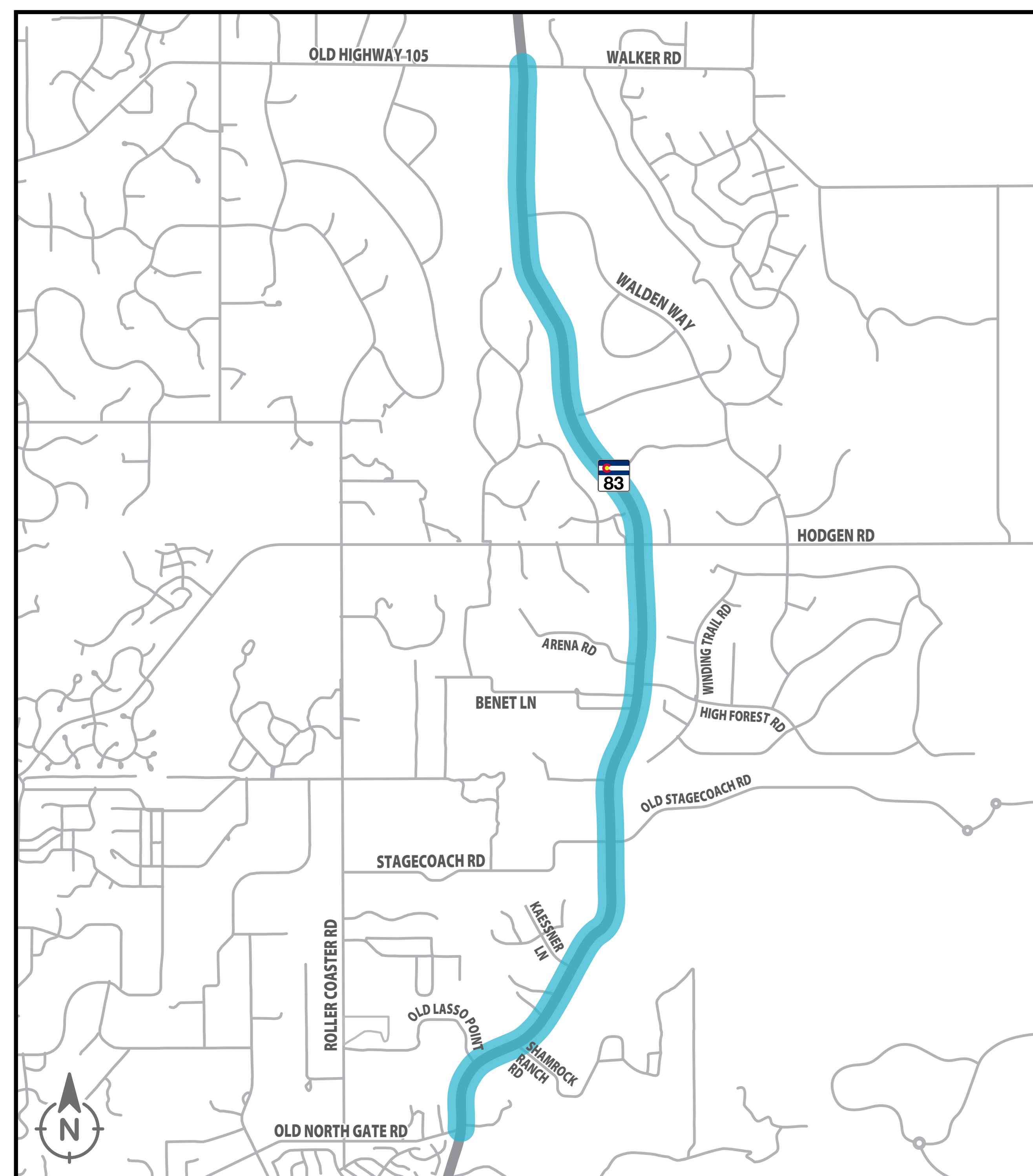

FOR MORE INFORMATION, REFER TO THE RECOMMENDATIONS STATION

EXISTING ACCESS CONDITIONS

(CONTINUED)

SEGMENT 3: CO 83 from Old Highway 105/Walker Road to Palmer Divide Road

- This segment is classified as a Regional Highway based on CDOT's State Highway Access Code.
- Regional Highways are intended to accommodate medium to high traffic volumes at medium to high travel speeds.
- Regional Highways are intended to provide service to through traffic movements, with lower priority on providing direct access to adjacent properties.
- Access to adjacent properties should be achieved through use of the local streets whenever reasonable.
- Spacing between signalized full movement intersections of one-half mile is preferred.
- Existing Number and Types of Access in Segment 3:
 - 13 total access points in 2.1 miles
 - 11 private driveways/field accesses and 2 public roads
 - All provide full-movement access and 1 intersection has a traffic signal

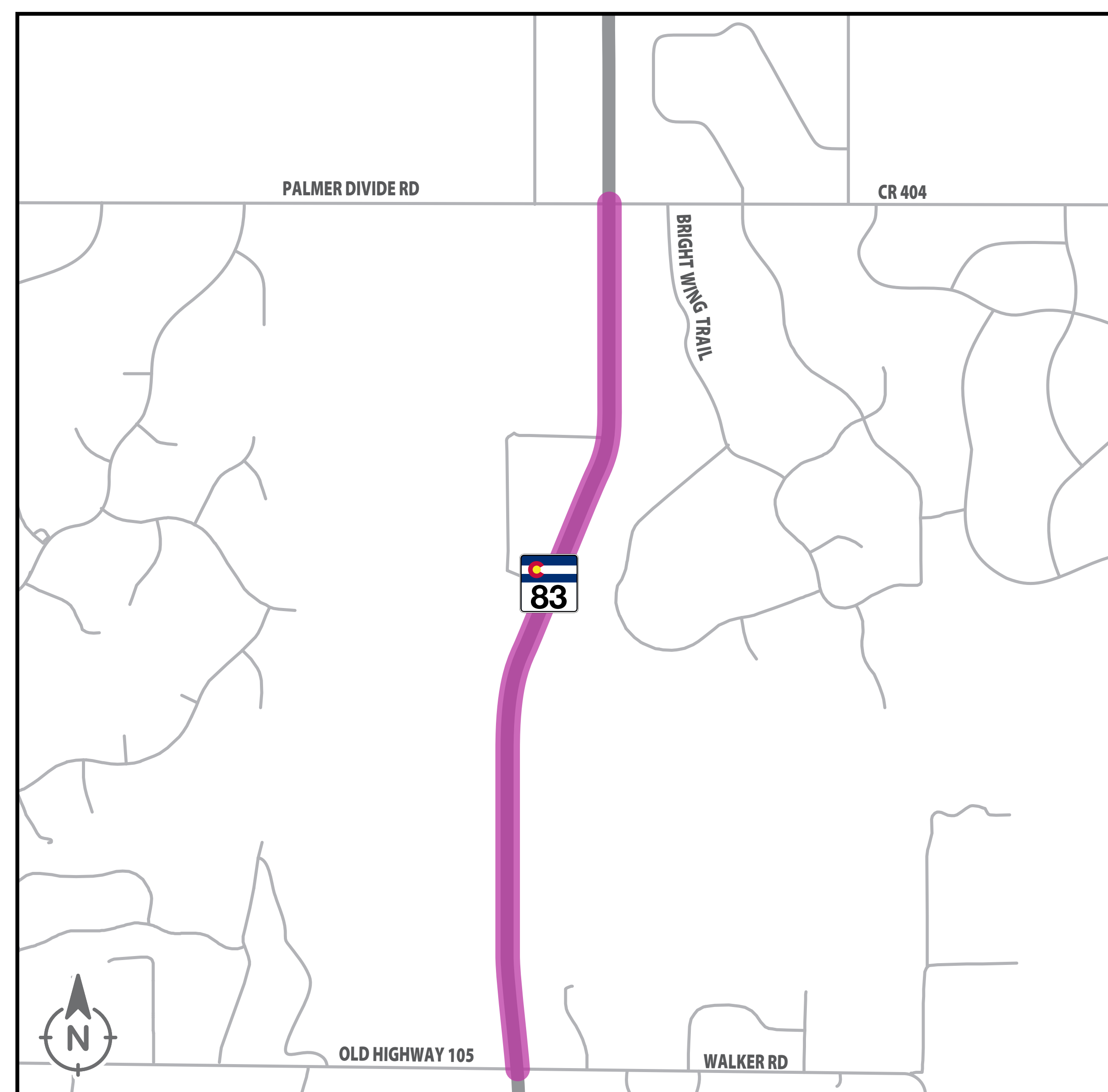

FOR MORE INFORMATION, REFER TO THE RECOMMENDATIONS STATION



COLORADO

Department of Transportation

CO 83 ACCESS STUDY

EXISTING SAFETY CONDITIONS



EXISTING SAFETY CONDITIONS

Crashes occur at conflict points, which are locations where two movements (vehicles, pedestrians, or bicyclists) cross paths.

Conflict Points by Access Type

Full Movement Access

- 4 Crossing
- 12 Turning
- 8 Merge/Diverge
- 8 Pedestrian

- 32 Total**

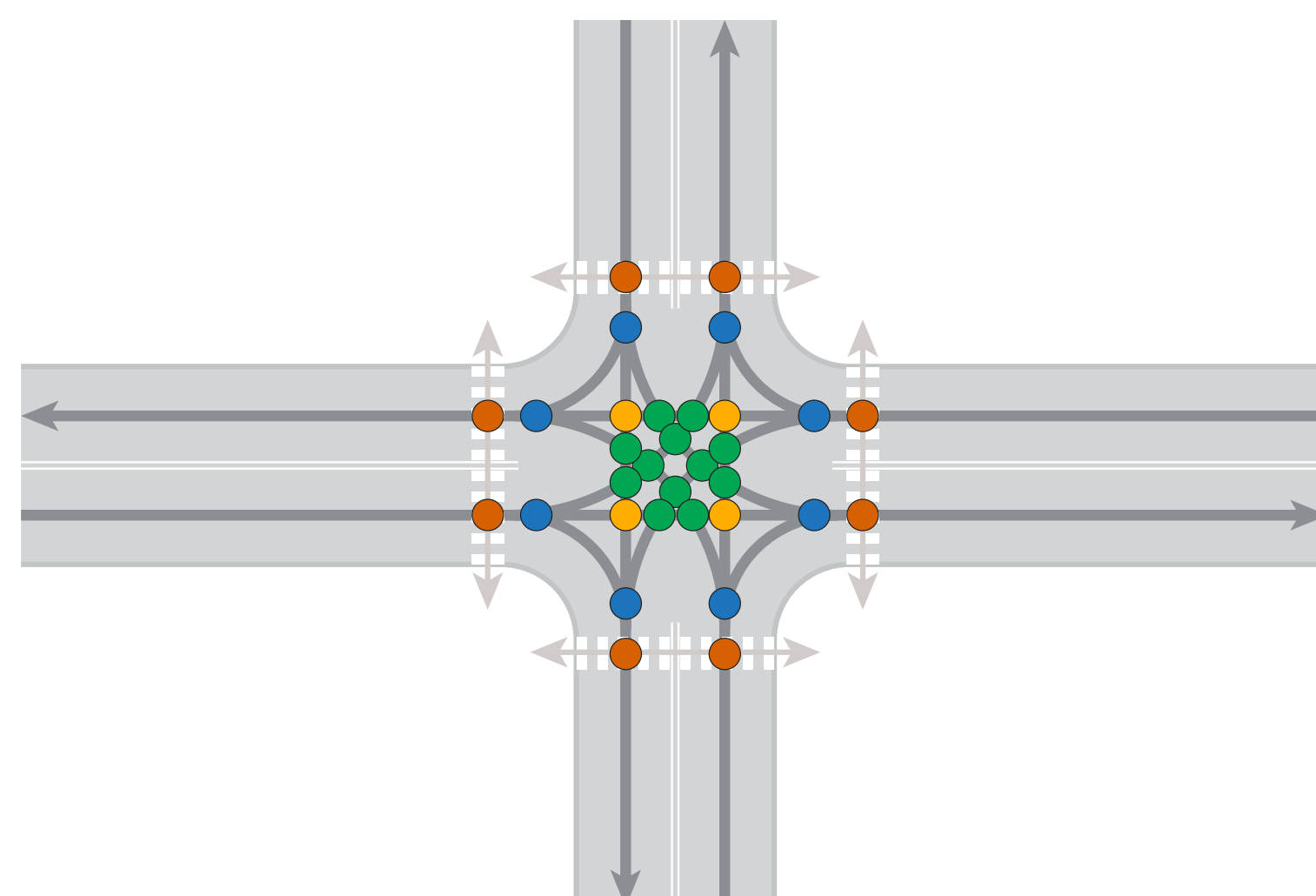

- All movements in all directions are allowed
- May include the need for a traffic signal

3/4 Movement Access

- 0 Crossing
- 2 Turning
- 8 Merge/Diverge
- 4 Pedestrian

- 14 Total**

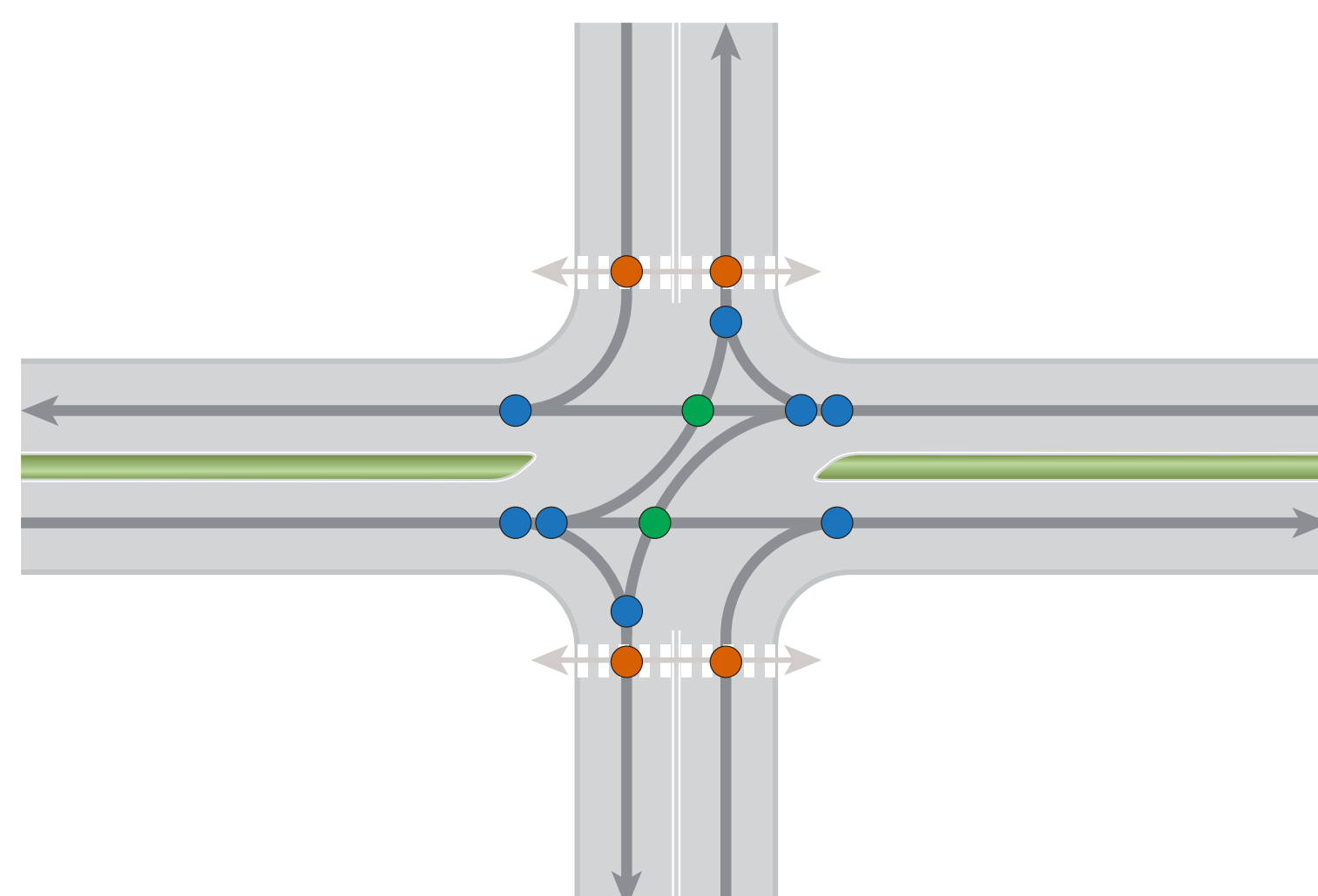

- Right-in, right-out and left-in are allowed
- Traffic median prevents left-out and straight movements—these movements must be completed at another intersection

Right-in/Right-out Access

- 0 Crossing
- 0 Turning
- 4 Merge/Diverge
- 4 Pedestrian

- 8 Total**

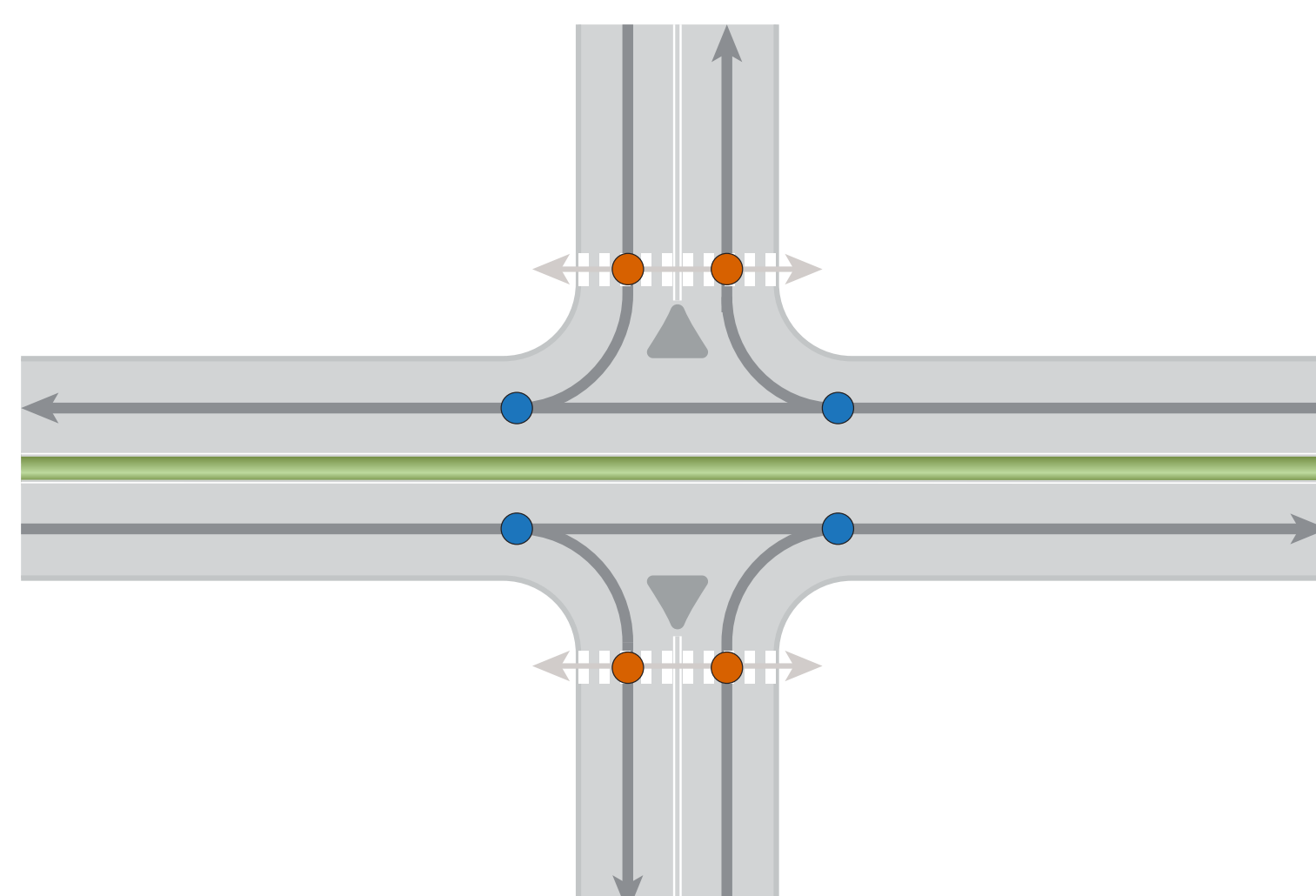

- Only right turns are allowed
- Traffic median prevents left turns and straight movements—these movements must be completed at another intersection

Roundabout

- 4 Crossing
- 0 Turning
- 16 Merge/Diverge
- 8 Pedestrian

- 28 Total**

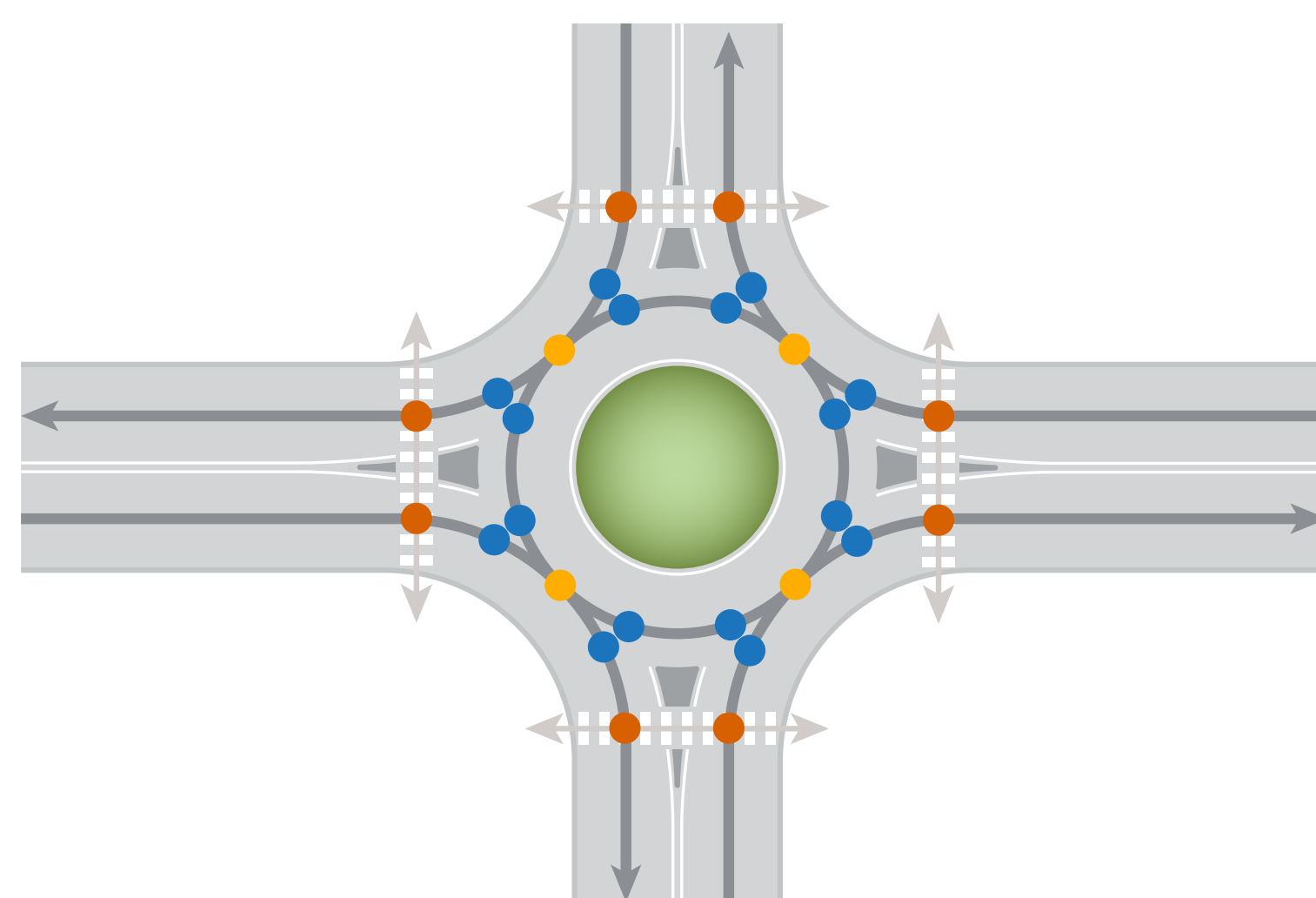

- All movements, including u-turns, are allowed at a circular intersection
- Raised circular median and signing directs drivers to travel in a counterclockwise movement through the intersection

Access studies identify ways to minimize conflict points in an effort to reduce crashes, improve traffic flow, and maintain appropriate access to adjacent properties.

EXISTING SAFETY CONDITIONS

(CONTINUED)

CDOT maintains a crash data base for all reported crashes that occur along a highway.

The safety performance of a highway is based on roadway characteristics, such as the number of lanes and the volume of traffic.

Highway safety performance is evaluated for crashes that occur at intersections and those that occur along segments in-between intersections (non-intersection).

Each intersection and segment of a highway then is evaluated to measure safety based on the expected safety for the given roadway characteristics. The result is called Level of Service of Safety or LOSS.

LOSS indicates the ability to reduce crashes by making changes to the design of an access or to the roadway.

LOSS is defined as follows:

- **LOSS I** indicates a low potential for crash reduction
- **LOSS II** indicates a low to moderate potential for crash reduction
- **LOSS III** indicates a moderate to high potential for crash reduction
- **LOSS IV** indicates a high potential for crash reduction

LOSS does not identify the nature of the safety problem, but a higher LOSS score helps to identify locations where additional analysis is needed.

An analysis of crash patterns is used to determine the nature of the safety problem and make recommendations to reduce crash potential at intersections or on highway segments.

EXISTING ACCESS CONDITIONS

Segment 1

Non-Intersection Related Crash Summary

Intersection Related Crash Summary

(CDOT crash data from 12/31/14 to 12/31/19)

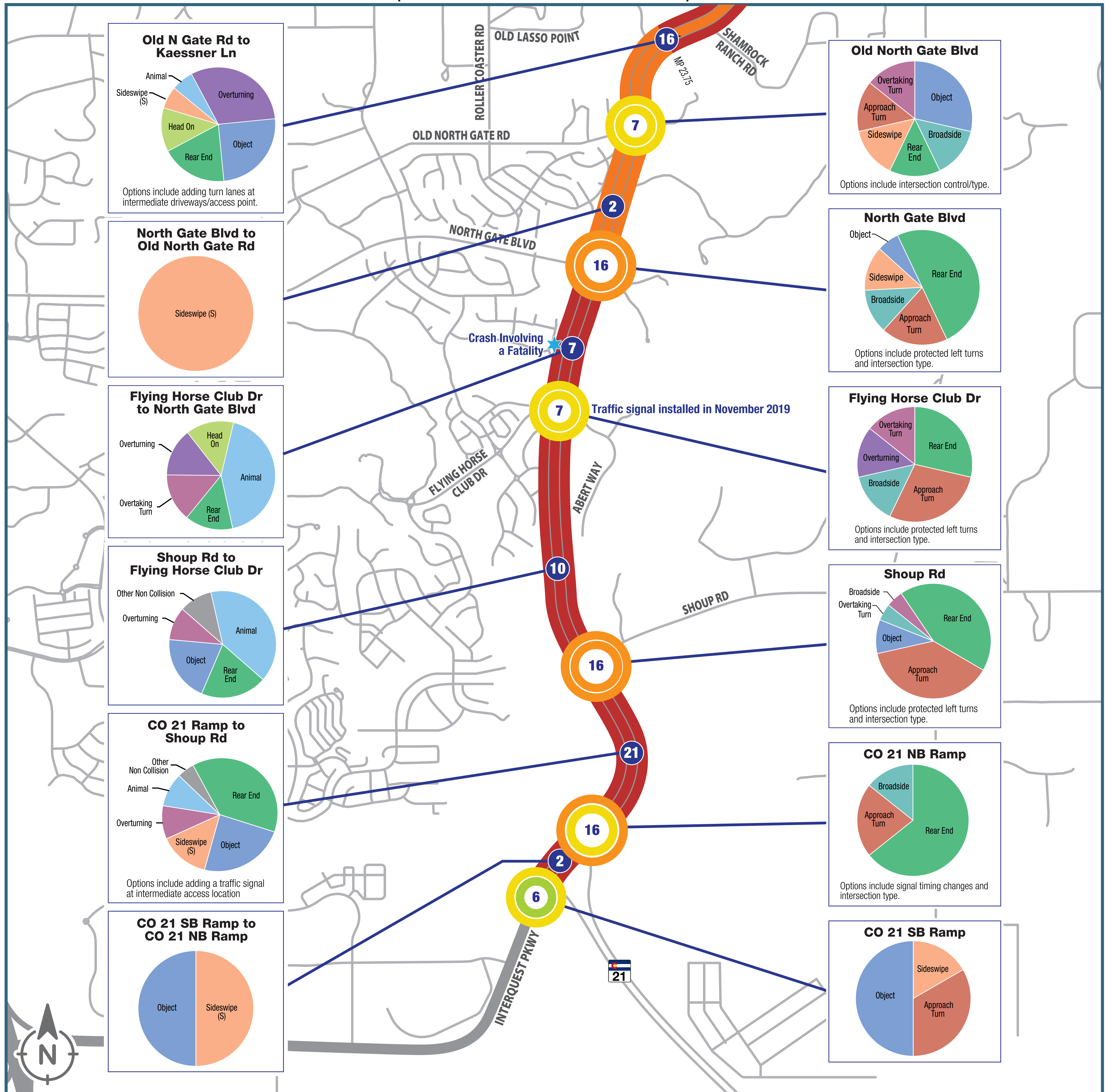

Legend

- Injury/Fatality LOSS
- Total LOSS
- X Number of crashes between intersections
- ★ Crash involving a fatality
- LOSS I (low potential to improve)
- LOSS II (low to moderate potential to improve)
- LOSS III (moderate to high potential to improve)
- LOSS IV (high potential to improve)
- X Number of intersections crashes
- Injury/Fatality LOSS
- Total LOSS

EXISTING ACCESS CONDITIONS

Segment 2

Non-Intersection Related Crash Summary

(CDOT crash data from 12/31/14 to 12/31/19)

Intersection Related Crash Summary

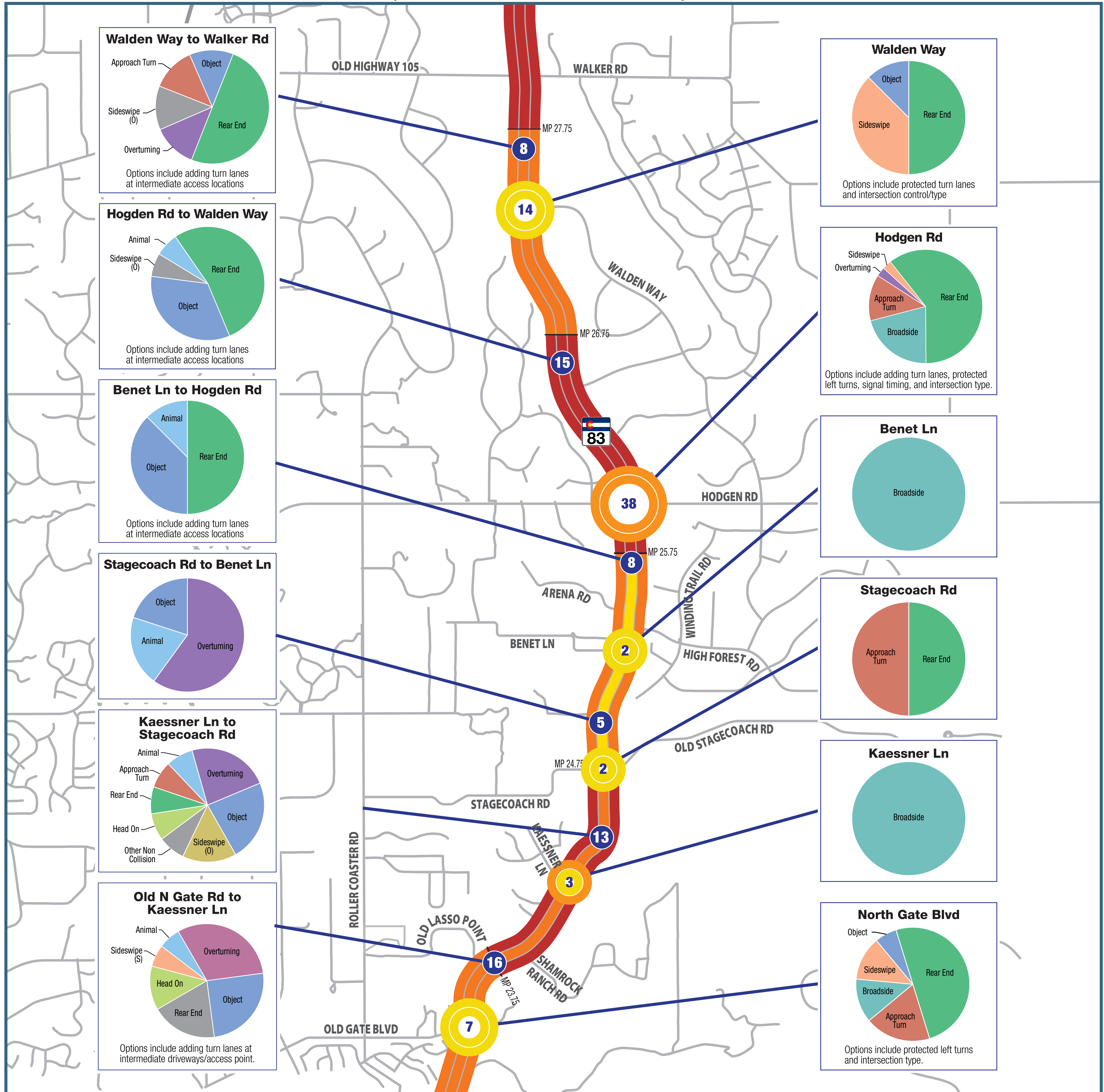

Legend

- Injury/Fatality LOSS
- Total LOSS
- Number of crashes between intersections
- Crash involving a fatality
- LOSS I (low potential to improve)
- LOSS II (low to moderate potential to improve)
- LOSS III (moderate to high potential to improve)
- LOSS IV (high potential to improve)
- Number of intersections crashes
- Injury/Fatality LOSS
- Total LOSS

EXISTING ACCESS CONDITIONS

Segment 3

Non-Intersection Related Crash Summary

(CDOT crash data from 12/31/14 to 12/31/19)

Intersection Related Crash Summary

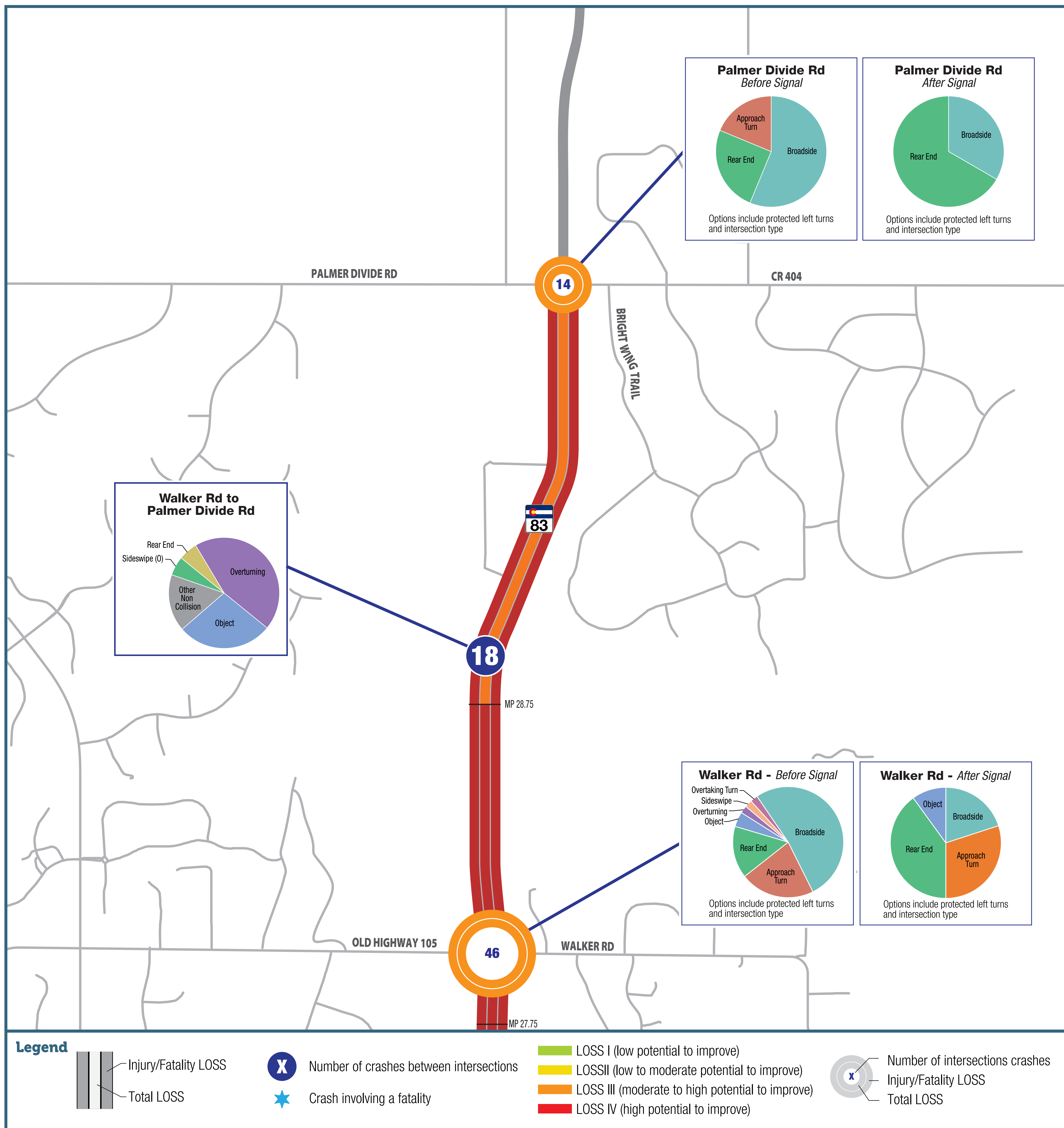

EXISTING SAFETY CONDITIONS

(CONTINUED)

CO 83 crash summary and observed patterns

- **Crash involving two vehicles on CO 83**
 - **Typical types of crashes:** rear end, side-swipe, and left turn
 - **Possible solutions:** reducing turn movements or using protected green arrows at traffic signals
- **Crash involving one vehicle on CO 83 and one vehicle on a side street**
 - **Typical types of crashes:** broadside and left turn
 - **Possible solutions:** reducing turn movements or constructing traffic signals or other intersection improvements
- **Crash involving two vehicles at a location between intersections on CO 83**
 - **Typical types of crashes:** rear end, broadside, and side-swipe
 - **Possible solutions:** reducing turn movements, increasing spacing between driveways, restricting driveway access near intersections, or adding turn lanes at access locations
- **There were no reported crashes involving pedestrians or bicyclists on CO 83**

CO 83 Overall Crash Summary (MP 20.37 to 30.24)

	Rear-End	Broadside	Object	Approach Turn	Overtaking	Sideswipe (same)	Animal	Other Non Collision	Overtaking Turn	Sideswipe (opposite)	Head-On	Total
Number	116	50	44	41	28	18	15	6	6	5	4	333
Percent	35%	15%	13%	12%	8%	5%	5%	2%	2%	2%	1%	—

Source: CDOT DiExSys™ (12/31/14 - 12/31/19)

RECOMMENDATIONS

SEGMENT 1: CO 21 to Old North Gate Road

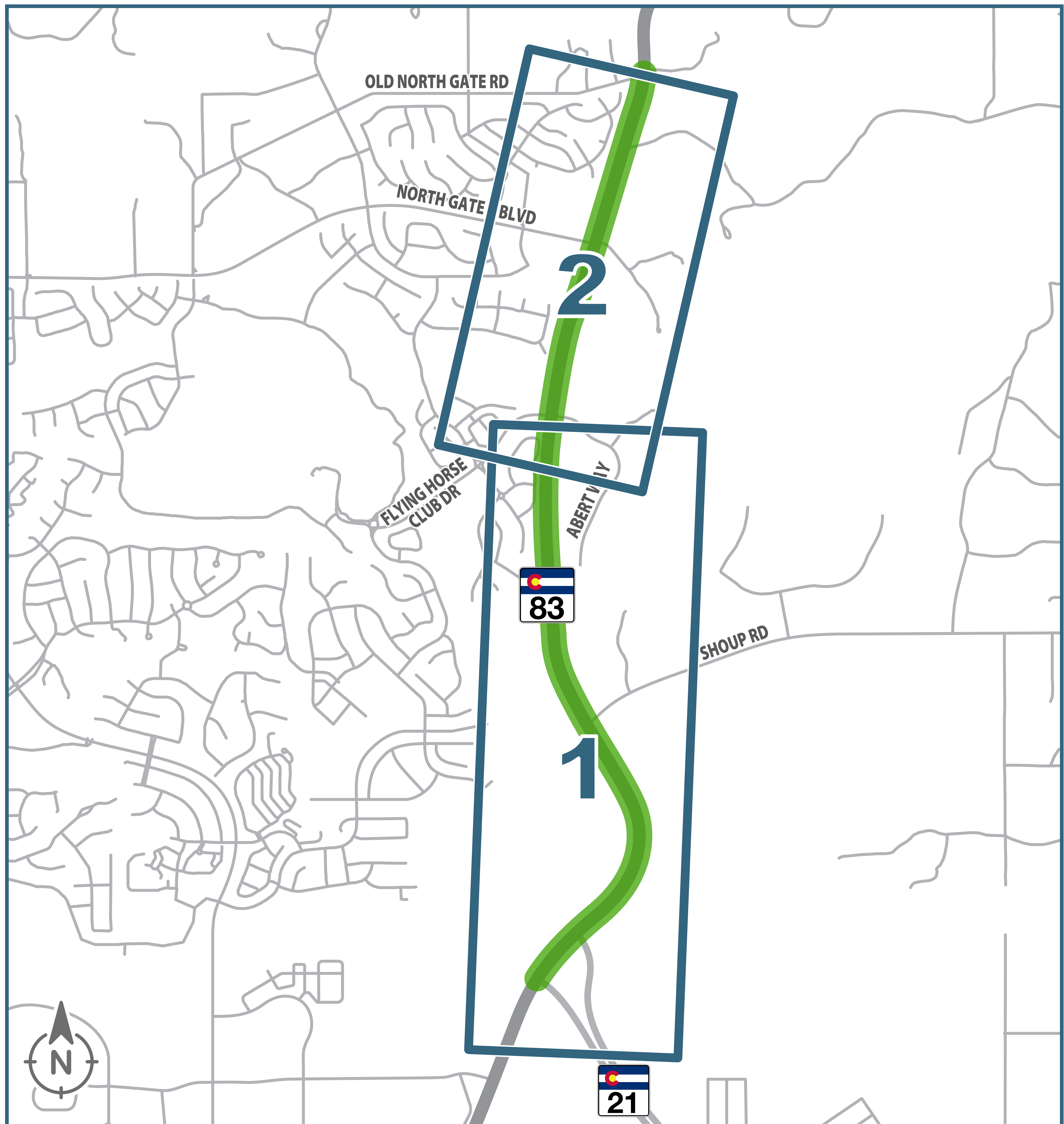

RECOMMENDATIONS

SEGMENT 2:

Old North Gate Road to Walker Road

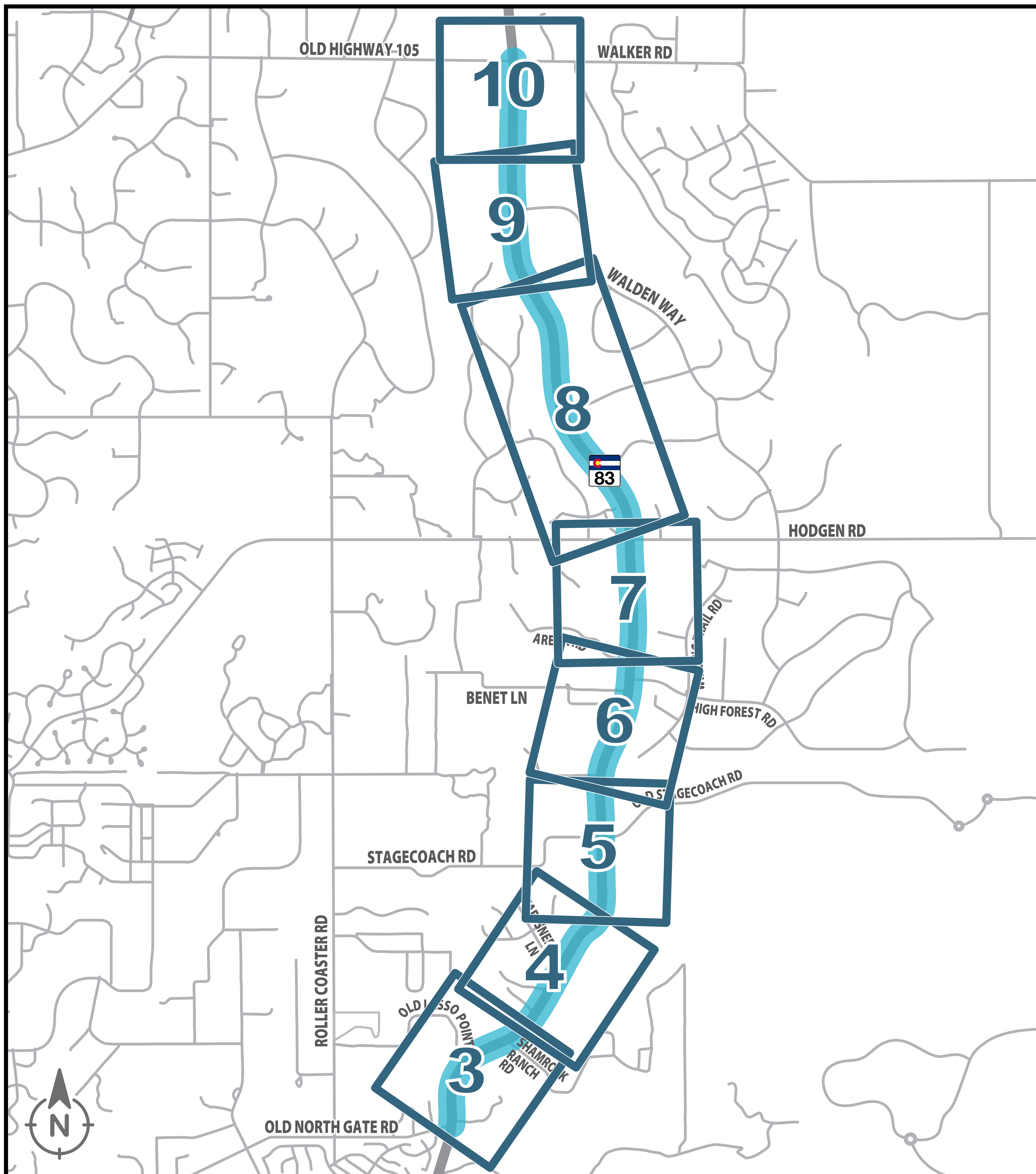

RECOMMENDATIONS

SEGMENT 3:

Walker Road to Palmer Divide Road

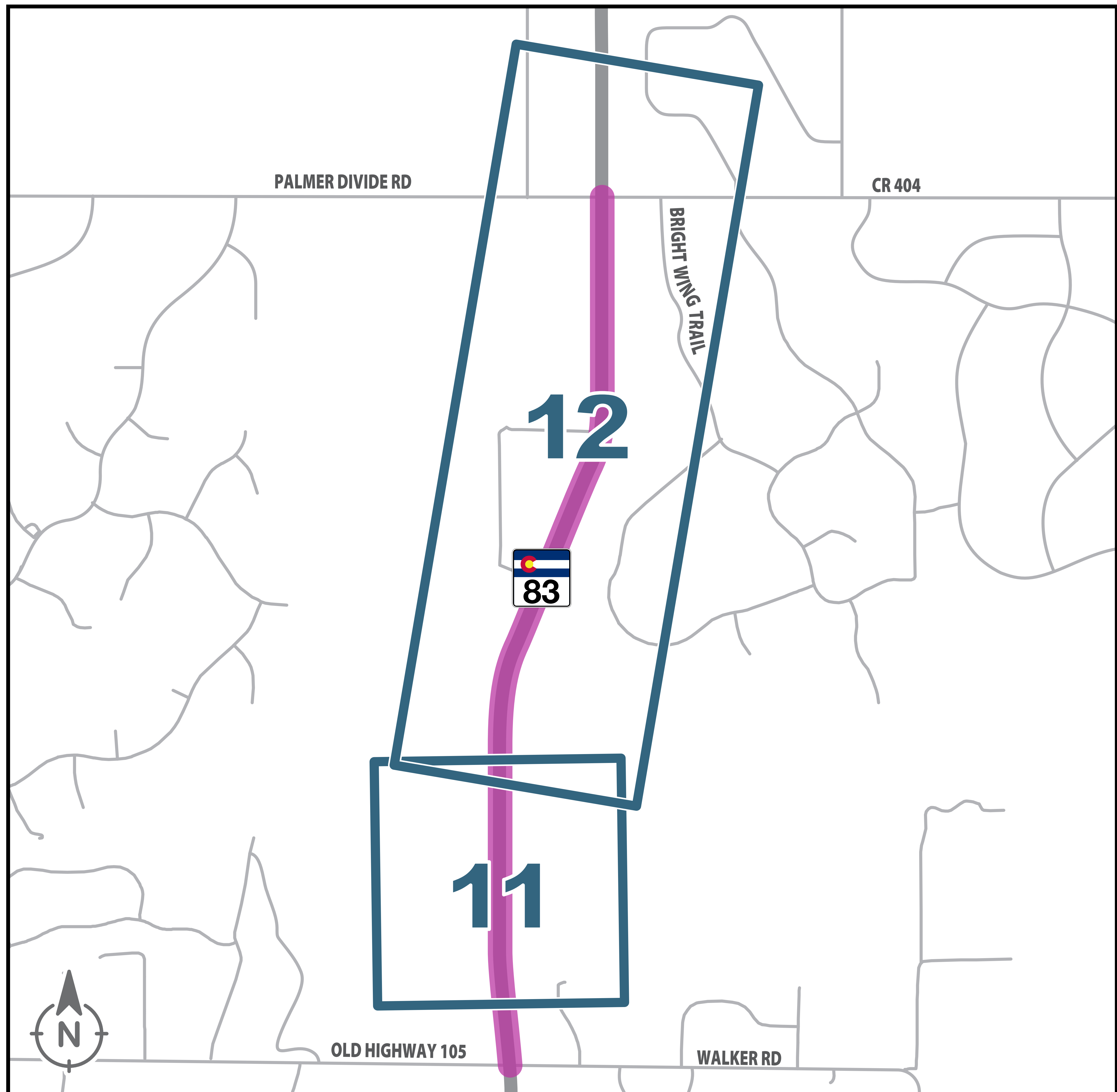



COLORADO

Department of Transportation

CO 83 ACCESS STUDY



CLOSING



LEAVE
A
COMMENT



CLOSING

How will the recommended changes in access benefit CO 83 users?

Enhance Safety

- A reduction in the number of conflict points reduces the potential for crashes.

Provide Access to Adjacent Properties

- All properties will have access to CO 83 or the local streets.

Support Future Development/Redevelopment

- Better access improves visual appeal of the highway to help attract development and visitors.

Increase Efficient Movement

- Fewer access points reduces congestion caused by vehicles turning onto and off of CO 83.

CLOSING

(CONTINUED)

THANK YOU FOR ATTENDING THE OPEN HOUSE!

Your participation is appreciated.
Please take a moment to:

- Complete a comment form.



[CLICK HERE FOR COMMENT FORM](#)

- Contact the study team:

Valerie Vigil, CDOT Permits Manager, at
Valerie.Vigil@state.co.us

Dave Sprague, Consultant Project Manager, at
david.sprague@atkinsglobal.com



COLORADO
Department of Transportation

E.4. Public Responses

The following are responses sent via email to individuals that provided comments at the second Highway 83 Access Study virtual meeting and the project team determined that an email response was appropriate with no additional follow up.

Dear Brett Gardner,

The City of Colorado Springs, El Paso County (County), and the Colorado Department of Transportation (CDOT), would like to thank you for taking the time to participate in the Highway 83 Access Study virtual Open House that recently concluded in July of 2021. We appreciate the time you took to provide feedback and comments on the study. We assure you that we are considering your thoughts and making necessary adjustments to the study's recommendations in order to improve access, mobility, and safety for all users of Highway 83.

This study is a long-term plan. The majority of the recommendations that we have shown will not happen unless there's redevelopment of a property, major changes to the highway, or if multiple property owners and the County decide that they want to work together to create an alternative access—such as creating access to a future signal. Thus, if a property does not redevelop (i.e., experience a significant change in land use) it will continue to have access to the highway, although it may be restricted to something less than full movement in the future. Also, as traffic increases or a highway improvement project adds lanes, this plan provides guidance on where future traffic signals may be located. In addition, the plan provides opportunities for the creation of alternative access so that most adjacent properties would have direct access to Highway 83 at a signalized location, which will improve safety.

You provided the following comments/questions about the study:

- Will your study also consider growing noise pollution along Hwy 83? This is especially relevant for residents along Hwy 83 in the Flying Horse community where I live. Specifically, in the area just south of Flying Horse Club Drive to Old Northgate Blvd. This is where the largest concentration of homes is located along the 83 corridor being studied. If you're going to study safety and access points, you should also consider noise pollution as an issue that should be addressed, as it's only getting worse (my perception).
- Traffic and noise pollution in this area has increased exponentially over the last few years, which is annoying and makes this wonderful community a less desirable place to live. Perhaps this will be somewhat alleviated when the Powers extension to I25 is completed one day, and also when the I25 Gap construction project is completed in the next two years, which may take away some traffic from 83 since many people don't like to take I25 due to construction and prefer to use 83 as a way around going north and south to COS, Castle Rock and Denver.
- I'd like to offer a few suggestions to possibly help with the growing noise pollution problem in this segment of Hwy 83 adjacent to Flying Horse (just south of Flying Horse Club Dr. to Old Northgate Blvd):
 - Pave the road with a low noise surface, like rubberized asphalt.
 - Install sound walls along the west side of 83 along this road segment.
 - Restrict large truck traffic from using 83.
 - Install sound meters along this segment with traffic cameras that would record the license plates of noise offensive vehicles, and issue warnings or fines in the mail to the individuals or companies operating loud, noisy vehicles (construction trucks and semi's are the worst offenders in this area of Hwy 83).
 - Study what other States or countries are doing to proactively reduce road noise pollution.

In response to your comment:

- The purpose of the access study is to determine where access should be allowed on Highway 83. This study does not look into issues such as noise, speeding, or design elements.
- CDOT recognizes the significant increase in traffic volumes on State Highway 83 as a result of the GAP project on I-25 and a 17% increase in Colorado's population since 2010. Several comments suggested that CDOT should restrict trucks on State Highway 83. State Statutes require that all state highways be open to truck traffic as the state highway system provides regional connectivity to various parts of the State. If trucks are restricted on State Highway, they will use more local and county roads.
- Engine compression brake devices, "Jake" brakes, reduce the load on foundation brakes, which helps prevent dangerous brake overheating. This keeps brakes available for emergencies. All commercial vehicles operating on any public roadway in Colorado equipped with an engine compression brake device are required by law to have mufflers. Even with proper use of mufflers, engine braking still produces a distinct sound. Because they are a safety device, the use of engine brakes is not prohibited on state highways. Prohibiting engine brakes would attempt to solve a noise problem without addressing the real cause, which is that some trucks have improperly muffled exhaust systems. CDOT does install signs stating "engine brake mufflers required" in our region if the local authorities, County Sheriff or City Police commit to enforcement of the sign. As of this point the El Paso County Sheriff does not enforce such signs.
- Thank you for the additional input on your concerns regarding noise levels on the corridor. When CDOT increases the capacity of the highway (such as widening a segment from two to four lanes), a noise study will be completed as part of the environmental clearance requirements for that project. Currently, CDOT does not have a Type II noise program—which means, CDOT does not retrofit existing roadways to mitigate for noise impacts unless capacity improvements or substantial physical changes to the highway geometry modify the existing highway. Noise impacts and abatement (berms and noise walls) are analyzed in accordance with both Federal and State guidelines, but this only occurs when a capacity or major geometric improvement occurs on the highway.

In summary:

- An access study does not investigate issues such as noise along the highway.
- State Statutes require that all state highways be open to truck traffic as the state highway system provides regional connectivity to various parts of the State.
- A traffic signal will only be installed if the intersection experiences poor traffic operations, there is a safety issue that can be corrected through the addition of adding a traffic signal, or if a traffic study is performed that indicates a traffic signal is warranted.
- Prohibiting engine brakes would attempt to solve a noise problem without addressing the real cause, which is that some trucks have improperly muffled exhaust systems. CDOT does install signs stating "engine brake mufflers required" in our region if the local authorities, County Sheriff or City Police commit to enforcement of the sign. As of this point the El Paso County Sheriff does not enforce such signs.
- CDOT appreciates your thoughts on additional mitigation measures that might help with sound issues along the highway, however, addressing such concerns would occur as part of the

environmental clearance process for a capacity or major geometric improvement project, and CDOT does not consider noise abatement without these criteria being met.

Thanks again for your participation and comments. If you require additional communication from the project team, please do not hesitate to contact one of us.

Very Respectfully,

Valerie Vigil
Colorado Department of Transportation, Permits Manager
Valerie.Vigil@state.co.us

Victoria Chavez
El Paso County, Principal Transportation Planner
VictoriaChavez@elpasoco.com

Jennifer Irvine
El Paso County, County Engineer
JenniferIrvine@elpasoco.com

David Sprague, PE
Consultant Project Manager
David.Sprague@atkinsglobal.com

Dear Brian Pickle,

The City of Colorado Springs, El Paso County (County), and the Colorado Department of Transportation (CDOT), would like to thank you for taking the time to participate in the Highway 83 Access Study virtual Open House that recently concluded in July of 2021. We appreciate the time you took to provide feedback and comments on the study. We assure you that we are considering your thoughts and making necessary adjustments to the study's recommendations in order to improve access, mobility, and safety for all users of Highway 83.

This study is a long-term plan. The majority of the recommendations that we have shown will not happen unless there's redevelopment of a property, major changes to the highway, or if multiple property owners and the County decide that they want to work together to create an alternative access—such as creating access to a future signal. Thus, if a property does not redevelop (i.e., experience a significant change in land use) it will continue to have access to the highway, although it may be restricted to something less than full movement in the future. Also, as traffic increases or a highway improvement project adds lanes, this plan provides guidance on where future traffic signals may be located. In addition, the plan provides opportunities for the creation of alternative access so that most adjacent properties would have direct access to Highway 83 at a signalized location, which will improve safety.

You provided the following comments/questions about the study:

- After "fixing" the intersection of Hwy 83 and Stagecoach they did not make a north bound left turn lane going west on Stagecoach. A person has to STOP in the main lane of the highway, so they get rear-ended often.
- We have no right-side turn lane to safely exit into our driveway and traffic goes way too fast. We also have to stop highway traffic to exit, and risk being rear-ended! The posted speed should be 45 mph from Northgate to Hodgen because of the narrow, winding two-lane road. Or just widen the road to 4-lanes.
- Lots of traffic from I-25 is coming over to Hwy 83 due to the construction, meaning lots of oversized trucks, large equipment haulers, semi-trailers, tandem trailers; all going way too fast to make turning or exiting safe. We have an at-risk elderly lady living here and we are very afraid that sooner or later she will be injured or killed trying to enter or exit our property. We need relief and we need it soon.

In response to your comment:

- The purpose of the access study is to determine where access should be allowed on Highway 83. This study does not make recommendations for changing the design of the roadway, to include auxiliary turn lanes at driveways or intersections. However, the Colorado Department of Transportation (CDOT) evaluates highways each year to determine the need for improvements to address safety and operational issues. There have been several concerns raised at the Stagecoach/CO 83 intersection and CDOT is currently working with the local property owners and the County to develop a solution that will address the safety concerns, including the potential need for additional auxiliary lanes. The Colorado Department of Transportation (CDOT) uses the proposed Access Control Plan as one of many steps to improving highway safety. Reconfiguring access locations and providing proper auxiliary lanes is a key factor to improving

the highway safety. This plan will be used to continually make highway improvements as new development occurs in this portion of El Paso County or as roadway projects emerge from State and County Planning efforts.

- It should be noted, CDOT recognizes the significant increase in traffic volumes on State Highway 83 as a result of the GAP project on I-25 and a 17% increase in Colorado's population since 2010. Several comments suggested that CDOT should restrict trucks on State Highway 83. State Statutes require that all state highways be open to truck traffic as the state highway system provides regional connectivity to various parts of the State, so that is not feasible as long as CO 83 is a State Highway.
- One of the most frequently heard complaints on this corridor is the speed of traffic. It's a common belief of the public's that lower speed limits are the solution to many crash and traffic problems. Studies have shown that most people will drive the speed at which they perceive the conditions to be safe and thus the Colorado State Statutes control how the speed limits are set on all public roadways. This Statute requires that speed limits shall not be higher or lower than the prima facie speed limits. Prima facie speed limits are those, which "at first appearance" are reasonable and prudent under normal roadway conditions. An appropriate, or "prima facia" speed limit will result in the maximum number of vehicles traveling at about the same speed, thus reducing conflicts caused by speed differentials. CDOT uses the 85th percentile speed, that speed at or below which 85% of the traffic is moving, as widely accepted as being closest to that "prima facia" speed limit.

In summary:

- CDOT is working with the local property owners and the County to address the safety concerns at Stagecoach Road.
- State Statutes require that all state highways be open to truck traffic as the state highway system provides regional connectivity to various parts of the State.
- CDOT uses the 85th percentile speed, that speed at or below which 85% of the traffic is moving, as widely accepted as being closest to that "prima facia" speed limit.

Thanks again for your participation and comments. If you require additional communication from the project team, please do not hesitate to contact one of us.

Very Respectfully,

Valerie Vigil
Colorado Department of Transportation, Permits Manager
Valerie.Vigil@state.co.us

Victoria Chavez
El Paso County, Principal Transportation Planner
VictoriaChavez@elpasoco.com

Jennifer Irvine
El Paso County, County Engineer
JenniferIrvine@elpasoco.com

David Sprague, PE

Consultant Project Manager
David.Sprague@atkinsglobal.com

Dear Chuck and Kim Kruger,

The City of Colorado Springs, El Paso County (County), and the Colorado Department of Transportation (CDOT), would like to thank you for taking the time to participate in the Highway 83 Access Study virtual Open House that recently concluded in July of 2021. We appreciate the time you took to provide feedback and comments on the study. We assure you that we are considering your thoughts and making necessary adjustments to the study's recommendations in order to improve access, mobility, and safety for all users of Highway 83.

This study is a long-term plan. The majority of the recommendations that we have shown will not happen unless there's redevelopment of a property, major changes to the highway, or if multiple property owners and the County decide that they want to work together to create an alternative access—such as creating access to a future signal. Thus, if a property does not redevelop (i.e., experience a significant change in land use) it will continue to have access to the highway, although it may be restricted to something less than full movement in the future. Also, as traffic increases or a highway improvement project adds lanes, this plan provides guidance on where future traffic signals may be located. In addition, the plan provides opportunities for the creation of alternative access so that most adjacent properties would have direct access to Highway 83 at a signalized location, which will improve safety.

You provided the following comments/questions about the study:

- Once again presented via virtual on-line only; even after specifically telling committee the last time that this is NOT effective communication especially with the older community in Black Forest. COVID is over so an in-person Open House MUST be done so all impacted property owners are aware. Physical Open House with notifications in the paper; over the local news is needed unless misinformation and miscommunication is your objective.
- Yes, you will either be closing our access to our only property egress or making right in-out only; forcing us to go WAY out of our way in order to go south into town/work; even though we're only a block from Northgate; de-valuing our property and cutting down the forest in the process. You refuse to implement simple changes including reducing speed-limits, limiting truck traffic, providing alternate routes for re-routed I-25 construction traffic, additional police enforcement-thru lack of action CDOT is literally forcing dangerous scenarios.
- We provided numerous comments previously and spoke with project team. No changes made so our input is evidently not important. We need to work together to come to a solution that benefits homeowners and CDOT. This current approach only appears to have a positive outcome for you and the developers. We will lose property, de-value our property, and destruction of the beauty of the Black Forest. Very sad and disappointing. You MUST have a real open house, where real people can talk to real people and voice concerns; feeling that their opinions really are important. Your current approach gives the appearance of being underhanded and deceptive. We would hope for better. Please work more closely with the Black Forest community for a positive outcome for all.

In response to your comment:

- CDOT considered the possibility to conduct an open house in-person instead of using the virtual format. All parties agree that in person communication would have been the preferred option.

However, CDOT, in agreement with El Paso County, made the decision to use the virtual format again due to so many individuals that are still afraid to participate in an indoor event with crowds. We understand your concerns and wishes to have an in-person meeting but unfortunately due to the times and concerns for all public participants, and members of the project team, this project will proceed forward to conclusion without conducting an in-person meeting.

- The purpose of the access study is to determine where access should be allowed on Highway 83. CDOT recognizes the significant increase in traffic volumes on State Highway 83 as a result of the GAP project on I-25 and a 17% increase in Colorado's population since 2010. Several comments suggested that CDOT should restrict trucks on State Highway 83. State Statutes require that all state highways be open to truck traffic as the state highway system provides regional connectivity to various parts of the State, so that is not feasible as long as CO 83 is a State Highway.
- One of the most frequently heard complaints on this corridor is the speed of traffic. It's a common belief of the public's that lower speed limits are the solution to many crash and traffic problems. Studies have shown that most people will drive the speed at which they perceive the conditions to be safe and thus the Colorado State Statutes control how the speed limits are set on all public roadways. This Statute requires that speed limits shall not be higher or lower than the prima facie speed limits. Prima facie speed limits are those, which "at first appearance" are reasonable and prudent under normal roadway conditions. An appropriate, or "prima facia" speed limit will result in the maximum number of vehicles traveling at about the same speed, thus reducing conflicts caused by speed differentials. CDOT uses the 85th percentile speed, that speed at or below which 85% of the traffic is moving, as widely accepted as being closest to that "prima facia" speed limit.
- CDOT and the project team take each comment seriously and we fairly evaluated the merit of the comment before responding or making changes to the plan. Your comments are no different and were given serious consideration as is apparent when we reached out to hold a phone conversation to hear your thoughts and discuss them in more detail.
 - As stated during our phone call, the purpose of the Access Control Plan is to develop a long-term solution to access conditions along Highway 83. There are no planned projects at the current time that would result in changes to your access now or in the near future.
 - The plan does show ultimate closure of your driveway; however, the plan also makes it clear that such a closure would only occur if you redevelop your property or sell your property to another owner that then redevelops the land, and if alternate access is available from another property. If you do not sell your property and you do not redevelop, then your driveway will not be closed. It will remain open in its current location.
 - The plan also makes it clear that your driveway may be restricted to less than full movement, such as a right-in, right-out, but only if:
 - A safety or operational issues occurs. Should it become too difficult or unsafe for you to turn left out of your driveway then your driveway may be restricted for your own safety to make you go right to a location where you can turn around safely and then travel south on Highway 83, or

- If a project adds a median to the highway, and at that time, if it is not possible to provide you with a safe way to turn left then your driveway will be restricted to right-in, right-out.
- The plan does show shared access between your property and adjacent properties. If redevelopment of one of the adjacent properties occurs that would enable access, drivers from your property would be able to access to Highway 83 from a traffic signal, which is safer than an unsignalized access.
 - However, CDOT nor the County can require you to share access unless you agree to pursue such an option.
 - The shared access concepts are intended to show that if your property is redeveloped or if the property next to you is redeveloped, then other access options should be investigated to ensure that your property is provided with the best and safest possible access options.

In summary:

- Due to the safety and public health concerns for all participants of the Open House, the decision was made to conduct the last public meeting in the virtual format instead of in-person.
- State Statutes require that all state highways be open to truck traffic as the state highway system provides regional connectivity to various parts of the State.
- CDOT uses the 85th percentile speed, that speed at or below which 85% of the traffic is moving, as widely accepted as being closest to that "prima facia" speed limit.
- CDOT and the project team take each comment, including yours and those that you previously submitted, seriously and we fairly evaluate the merit of the comment before responding or making changes to the plan.
 - The plan makes it clear that closing your access would only occur if you redevelop your property or sell your property to another owner that then redevelops the land. If you do not sell your property and you do not redevelop, then your driveway will not be closed. It will remain open in its current location.
 - The plan also makes it clear that your driveway may be restricted to less than full movement, such as a right-in, right-out, but only if:
 - A safety or operational issues occurs. Should it become too difficult or unsafe for you to turn left out of your driveway then your driveway may be restricted for your own safety to make you go right to a location where you can turn around safely and then travel south on Highway 83, or
 - If a project adds a median to the highway, and at that time, if it is not possible to provide you with a safe way to turn left then your driveway will be restricted to right-in, right-out.

Thanks again for your participation and comments. If you require additional communication from the project team, please do not hesitate to contact one of us.

Very Respectfully,

Valerie Vigil

Colorado Department of Transportation, Permits Manager

Valerie.Vigil@state.co.us

Victoria Chavez
El Paso County, Principal Transportation Planner
VictoriaChavez@elpasoco.com

Jennifer Irvine
El Paso County, County Engineer
JenniferIrvine@elpasoco.com

David Sprague, PE
Consultant Project Manager
David.Sprague@atkinsglobal.com

Dear Curtis Dicke,

The City of Colorado Springs, El Paso County (County), and the Colorado Department of Transportation (CDOT), would like to thank you for taking the time to participate in the Highway 83 Access Study virtual Open House that recently concluded in July of 2021. We appreciate the time you took to provide feedback and comments on the study. We assure you that we are considering your thoughts and making necessary adjustments to the study's recommendations in order to improve access, mobility, and safety for all users of Highway 83.

This study is a long-term plan. The majority of the recommendations that we have shown will not happen unless there's redevelopment of a property, major changes to the highway, or if multiple property owners and the County decide that they want to work together to create an alternative access—such as creating access to a future signal. Thus, if a property does not redevelop (i.e., experience a significant change in land use) it will continue to have access to the highway, although it may be restricted to something less than full movement in the future. Also, as traffic increases or a highway improvement project adds lanes, this plan provides guidance on where future traffic signals may be located. In addition, the plan provides opportunities for the creation of alternative access so that most adjacent properties would have direct access to Highway 83 at a signalized location, which will improve safety.

You provided the following comments/questions about the study:

- Will the killer curves be removed on 83?
- Will the very loud truckers/motorcycles/speeding cars still rampage up and down this stretch?

In response to your comment:

- The purpose of the access study is to determine where access should be allowed on Highway 83. This study does not make recommendations for changing the design of the roadway, to include auxiliary turn lanes at driveways/intersections, road widening, or realignment of the road to eliminate curves. However, the Colorado Department of Transportation (CDOT) evaluates highways each year to determine the need for improvements to address safety and operational issues. The Colorado Department of Transportation (CDOT) uses the proposed Access Control Plan as one of many steps to improving highway safety. Reconfiguring access locations and providing proper auxiliary lanes is a key factor to improving the highway safety. This plan will be used to continually make highway improvements as new development occurs in this portion of El Paso County or as roadway projects emerge from State and County Planning efforts.
- CDOT recognizes the significant increase in traffic volumes on State Highway 83 as a result of the GAP project on I-25 and a 17% increase in Colorado's population since 2010. Several comments suggested that CDOT should restrict trucks on State Highway 83. State Statutes require that all state highways be open to truck traffic as the state highway system provides regional connectivity to various parts of the State. If trucks are restricted on State Highway, they will use more local and county roads.
- One of the most frequently heard complaints on this corridor is the speed of traffic. It's a common belief of the public's that lower speed limits are the solution to many crash and traffic problems. Studies have shown that most people will drive the speed at which they perceive the conditions to be safe and thus the Colorado State Statutes control how the speed limits are set

on all public roadways. This Statute requires that speed limits shall not be higher or lower than the prima facie speed limits. Prima facie speed limits are those, which "at first appearance" are reasonable and prudent under normal roadway conditions. An appropriate, or "prima facia" speed limit will result in the maximum number of vehicles traveling at about the same speed, thus reducing conflicts caused by speed differentials. CDOT uses the 85th percentile speed, that speed at or below which 85% of the traffic is moving, as widely accepted as being closest to that "prima facia" speed limit.

- Engine compression brake devices, "Jake" brakes, reduce the load on foundation brakes, which helps prevent dangerous brake overheating. This keeps brakes available for emergencies. All commercial vehicles operating on any public roadway in Colorado equipped with an engine compression brake device are required by law to have mufflers. Even with proper use of mufflers, engine braking still produces a distinct sound. Because they are a safety device, the use of engine brakes is not prohibited on state highways. Prohibiting engine brakes would attempt to solve a noise problem without addressing the real cause, which is that some trucks have improperly muffled exhaust systems. CDOT does install signs stating "engine brake mufflers required" in the region IF the local authorities, County Sheriff or City Police commit to enforcement of the sign. As of this point the El Paso County Sheriff does not enforce such signs.

In summary:

- The purpose of the access study is to determine where access should be allowed on Highway 83. This study does not make recommendations for changing the design of the roadway, to include auxiliary turn lanes at driveways/intersections, road widening, or realignment of the road to eliminate curves.
- State Statutes require that all state highways be open to truck traffic as the state highway system provides regional connectivity to various parts of the State.
- CDOT uses the 85th percentile speed, that speed at or below which 85% of the traffic is moving, as widely accepted as being closest to that "prima facia" speed limit.
- CDOT does install signs stating "engine brake mufflers required" in the region IF the local authorities, County Sheriff or City Police commit to enforcement of the sign. As of this point the El Paso County Sheriff does not enforce such signs.

Thanks again for your participation and comments. If you require additional communication from the project team, please do not hesitate to contact one of us.

Very Respectfully,

Valerie Vigil
Colorado Department of Transportation, Permits Manager
Valerie.Vigil@state.co.us

Victoria Chavez
El Paso County, Principal Transportation Planner
VictoriaChavez@elpasoco.com

Jennifer Irvine
El Paso County, County Engineer
JenniferIrvine@elpasoco.com

David Sprague, PE
Consultant Project Manager
David.Sprague@atkinsglobal.com

Dear Gary and Carol Cox,

The City of Colorado Springs, El Paso County (County), and the Colorado Department of Transportation (CDOT), would like to thank you for taking the time to participate in the Highway 83 Access Study virtual Open House that recently concluded in July of 2021. We appreciate the time you took to provide feedback and comments on the study. We assure you that we are considering your thoughts and making necessary adjustments to the study's recommendations in order to improve access, mobility, and safety for all users of Highway 83.

This study is a long-term plan. The majority of the recommendations that we have shown will not happen unless there's redevelopment of a property, major changes to the highway, or if multiple property owners and the County decide that they want to work together to create an alternative access—such as creating access to a future signal. Thus, if a property does not redevelop (i.e., experience a significant change in land use) it will continue to have access to the highway, although it may be restricted to something less than full movement in the future. Also, as traffic increases or a highway improvement project adds lanes, this plan provides guidance on where future traffic signals may be located. In addition, the plan provides opportunities for the creation of alternative access so that most adjacent properties would have direct access to Highway 83 at a signalized location, which will improve safety.

You provided the following comments/questions about the study:

- There is no grey bar reflecting where the new road will be to exit at 79. Second, why isn't the section line being used to give straight access to Evergreen Rd. This would be the only straight road to Roller Coaster Rd.

In response to your comment:

- First, the maps do not include gray lines depicting the location of future roads, unless they appear on a State of County level planning document. The recommendation to have a new access (#79) just north of Access #31 assumes future re-development would occur to one or more of the adjacent properties. If and when that redevelopment occurs, Access #31 would be closed, and the new access (#79) would be constructed. If re-development of these parcels does not happen, Access #31 will remain open. In addition, the actual location and roadway design of any new access, such as #79, would be determined by the developer (and would be submitted to CDOT and the County) when the project is designed. At that time, the design of Access #79 would take into consideration sight distance and other safety factors to ensure the best location is selected and the appropriate design is constructed.
- Extending Evergreen Road from the west over to Highway 83 was an improvement option discussed by the project team. However, the accesses west of CO 83 are currently shared driveways on privately owned land. This means that in order for Evergreen Road to be extended, the County would need to purchase a significant amount of right-of-way from property owners, and this improvement is not identified as part of the County's long-term roadway improvement plans. It was determined that due to the significant costs, the impacts to existing homes that are near where the road would be, and terrain issues, that this was not a feasible option to carry forward. Furthermore, if Evergreen Road was to extend to Highway 83 it would not change any of the recommendations for Access #31 or #79.

In summary:

- Access #31 will remain open until redevelopment of the adjacent properties occurs, at which time a new access (#79) may be considered.
- The extension of Evergreen Road is not currently being considered by the County as a possible future project due to the high costs and impacts to property owners that would be required.

Thanks again for your participation and comments. If you require additional communication from the project team, please do not hesitate to contact one of us.

Very Respectfully,

Valerie Vigil
Colorado Department of Transportation, Permits Manager
Valerie.Vigil@state.co.us

Victoria Chavez
El Paso County, Principal Transportation Planner
VictoriaChavez@elpasoco.com

Jennifer Irvine
El Paso County, County Engineer
JenniferIrvine@elpasoco.com

David Sprague, PE
Consultant Project Manager
David.Sprague@atkinsglobal.com

Dear Gary Helfeldt,

The City of Colorado Springs, El Paso County (County), and the Colorado Department of Transportation (CDOT), would like to thank you for taking the time to participate in the Highway 83 Access Study virtual Open House that recently concluded in July of 2021. We appreciate the time you took to provide feedback and comments on the study. We assure you that we are considering your thoughts and making necessary adjustments to the study's recommendations in order to improve access, mobility, and safety for all users of Highway 83.

This study is a long-term plan. The majority of the recommendations that we have shown will not happen unless there's redevelopment of a property, major changes to the highway, or if multiple property owners and the County decide that they want to work together to create an alternative access—such as creating access to a future signal. Thus, if a property does not redevelop (i.e., experience a significant change in land use) it will continue to have access to the highway, although it may be restricted to something less than full movement in the future. Also, as traffic increases or a highway improvement project adds lanes, this plan provides guidance on where future traffic signals may be located. In addition, the plan provides opportunities for the creation of alternative access so that most adjacent properties would have direct access to Highway 83 at a signalized location, which will improve safety.

You provided the following comments/questions about the study:

- I am a property owner in the Flying Horse neighborhood along CO 83. If this the appropriate place to comment on the CO 83 Access Study, I would like to offer a recommendation for consideration. At access point #6, add access on the West side of 83 (at Shoop Rd) to the dirt/fill farm to provide route for commercial dump trucks that does not travers residential areas that are not designed to accommodate the weight or length of high-volume commercial truck traffic. Heavy commercial traffic has long been traversing the Flying Horse neighborhoods West of 83 where children and families play, skateboard, ride bicycles, etc. The commercial dump trucks may be exceeding allowed residential decibel levels (informal testing), and continue to inflict damage to roadways, curbs, sidewalks, traffic circles, and street signs. Adding an appropriate access way for commercial dirt hauling equipment would improve residential safety and restore traffic patterns to roadway design specs, while utilizing and improving upon a mature CO 83 intersection. Access point #6 is already a 3-way intersection with a traffic light, and looks to be immediately adjacent to the fill dirt park via a portion of land currently owned or controlled by the State of Colorado

In response to your comment:

- Although the property west of Highway 83, at Shoup Road, is owned by CDOT, CDOT does not develop local roadways. The development of an additional leg to this intersection that would go west would need to be a local project done by either a developer or the County. At the current time there are no plans to add a fourth leg to the Shoup Road intersection. In addition, the property west of Highway 83 has a significant drainage easement that would significantly increase the cost and difficulty in adding a roadway to this property.

In summary:

- Shoup Road will remain a three-leg intersection.

Thanks again for your participation and comments. If you require additional communication from the project team, please do not hesitate to contact one of us.

Very Respectfully,

Valerie Vigil
Colorado Department of Transportation, Permits Manager
Valerie.Vigil@state.co.us

Victoria Chavez
El Paso County, Principal Transportation Planner
VictoriaChavez@elspasoco.com

Jennifer Irvine
El Paso County, County Engineer
JenniferIrvine@elspasoco.com

David Sprague, PE
Consultant Project Manager
David.Sprague@atkinsglobal.com

Dear John Budnella,

The City of Colorado Springs, El Paso County (County), and the Colorado Department of Transportation (CDOT), would like to thank you for taking the time to participate in the Highway 83 Access Study virtual Open House that recently concluded in July of 2021. We appreciate the time you took to provide feedback and comments on the study. We assure you that we are considering your thoughts and making necessary adjustments to the study's recommendations in order to improve access, mobility, and safety for all users of Highway 83.

This study is a long-term plan. The majority of the recommendations that we have shown will not happen unless there's redevelopment of a property, major changes to the highway, or if multiple property owners and the County decide that they want to work together to create an alternative access—such as creating access to a future signal. Thus, if a property does not redevelop (significant change in land use) it will continue to have access to the highway, although it may be restricted to something less than full movement in the future. Also, as traffic increases or a highway improvement project adds lanes, this plan provides guidance on where future traffic signals may be located. In addition, the plan provides opportunities for the creation of alternative access so that most adjacent properties would have direct access to Highway 83 at a signalized location, which will improve safety.

You provided the following comments/questions about the study:

- As to the situation with Highway 83 from Northgate to Hodgen Road, I am amazed that the entities involved actually think the way it is now is safe. I am assuming that Atkins is involved with the design of the intersection at Stagecoach and 83. While this may fly in Dubai or China it is a disaster here. Numerous accidents have already occurred mainly because of the volume of traffic on a road that is woefully insufficient to handle it. While somebody was thinking by putting a deceleration lane southbound, they must only have used one side of the brain as there is nothing northbound. This creates an issue for anyone turning left to go home on the original Stagecoach Road that existed here since the 70's.
- It is obvious to anyone that safety is not the concern with government and developers involved. What is of concern to these entities is MONEY and only Money. As I said before I grew up here. As is standard the developer comes in, builds whatever, lines their pockets with gold and silver and waves goodbye. Then the taxpayers are left with the aftermath of whatever corners have been cut, whatever issues have been overlooked or ignored. Broadmoor Bluffs is a good example. Houses sliding away and the city has to buy back million-dollar homes. The developer is somewhere on a beach drinking pina coladas.
- Also this shows where the State concerns lie. Again Money. I'm sure that this would not be the case should this be Aspen, Vail, Boulder or Evergreen. The gap project is a good example of that, adding a toll lane that will only be available at certain times instead of adding an additional lane each direction.
- A simple solution to all this is a deceleration lane northbound at Stagecoach Road, a light, flashing lights at driveways and smaller roads, limit usage between Powers and Highway 105 to vehicles under 20k gross weight, and lowering the speed limit to 45 mph.
- I have said my piece I am sure this will fall on deaf ears. Maybe if I attach a check then my opinion will matter.

In response to your comment:

- CDOT has acknowledged the safety concerns at Stagecoach Road. While Atkins is the consultant on this study, Atkins was not involved in the design of the current intersection and that project is completely unrelated to this study. CDOT is working with the local property owners and El Paso County to address the safety concerns at this intersection and hopes to have a decision that will be included as part of this project's final plan.
- CDOT and El Paso County consider safety for all roadway users a top priority when developing projects such as this access control plan.
- CDOT does not control or make decisions regarding development along a highway. Those decisions are made by the local planning agency, which in this case is El Paso County.
- The purpose of the access study is to determine where access should be allowed on Highway 83. This study does not make recommendations for changing the design of the roadway, to include auxiliary lane at intersections. Those decisions are done under separate projects.
- CDOT recognizes the significant increase in traffic volumes on State Highway 83 as a result of the GAP project on I-25 and a 17% increase in Colorado's population since 2010. Several comments suggested that CDOT should restrict trucks on State Highway 83. State Statutes require that all state highways be open to truck traffic as the state highway system provides regional connectivity to various parts of the State, so that is not feasible as long as CO 83 is a State Highway.
- The Colorado Department of Transportation (CDOT) uses the proposed Access Control plan as one of many steps to improving highway safety. Reconfiguring access locations and providing proper auxiliary lanes is a key factor to improving the highway safety. This plan will be used to continually make highway improvements as new development occurs in this portion of El Paso County or as roadway projects emerge from State and County Planning efforts.
- One of the most frequently heard complaints on this corridor is the speed of traffic. It's a common belief of the public's that lower speed limits are the solution to many crash and traffic problems. Studies have shown that most people will drive the speed at which they perceive the conditions to be safe and thus the Colorado State Statutes control how the speed limits are set on all public roadways. This Statute requires that speed limits shall not be higher or lower than the prima facie speed limits. Prima facie speed limits are those, which "at first appearance" are reasonable and prudent under normal roadway conditions. An appropriate, or "prima facia" speed limit will result in the maximum number of vehicles traveling at about the same speed, thus reducing conflicts caused by speed differentials. CDOT uses the 85th percentile speed, that speed at or below which 85% of the traffic is moving, as widely accepted as being closest to that "prima facia" speed limit.

In summary:

- State Statutes require that all state highways be open to truck traffic as the state highway system provides regional connectivity to various parts of the State.
- CDOT uses the 85th percentile speed, that speed at or below which 85% of the traffic is moving, as widely accepted as being closest to that "prima facia" speed limit.
- CDOT is currently working with the local property owners and El Paso County to address safety concerns at Stagecoach Road and hopes to have a decision about changes that will be included in this project's final plan.

- Safety for all travelers and users of the highway is and always will be the top priority for CDOT and El Paso County.
- The purpose of the access study is to determine where access should be allowed on Highway 83. This study does not make recommendations for changing the design of the roadway, to include auxiliary lane at intersections. Those decisions are done under separate projects.

Thanks again for your participation and comments. If you require additional communication from the project team, please do not hesitate to contact one of us.

Very Respectfully,

Valerie Vigil
Colorado Department of Transportation, Permits Manager
Valerie.Vigil@state.co.us

Victoria Chavez
El Paso County, Principal Transportation Planner
VictoriaChavez@elpasoco.com

Jennifer Irvine
El Paso County, County Engineer
JenniferIrvine@elpasoco.com

David Sprague, PE
Consultant Project Manager
David.Sprague@atkinsglobal.com

Dear John Godsey,

The City of Colorado Springs, El Paso County (County), and the Colorado Department of Transportation (CDOT), would like to thank you for taking the time to participate in the Highway 83 Access Study virtual Open House that recently concluded in July of 2021. We appreciate the time you took to provide feedback and comments on the study. We assure you that we are considering your thoughts and making necessary adjustments to the study's recommendations in order to improve access, mobility, and safety for all users of Highway 83.

This study is a long-term plan. The majority of the recommendations that we have shown will not happen unless there's redevelopment of a property, major changes to the highway, or if multiple property owners and the County decide that they want to work together to create an alternative access—such as creating access to a future signal. Thus, if a property does not redevelop (i.e., experience a significant change in land use) it will continue to have access to the highway, although it may be restricted to something less than full movement in the future. Also, as traffic increases or a highway improvement project adds lanes, this plan provides guidance on where future traffic signals may be located. In addition, the plan provides opportunities for the creation of alternative access so that most adjacent properties would have direct access to Highway 83 at a signalized location, which will improve safety.

You provided the following comments/questions about the study:

- (1) The first concern is traffic volume itself. This highway has far more traffic traveling on it seemingly each year. Although some is due to construction concerns at the GAP on I25, it is not the primary reason as we know how volume due to growth is driving the increase. Naturally, we cannot really mitigate the volume, but must do what we can to facilitate the expeditious flow of traffic. Very slow-moving trucks traffic can reduce the speed of vehicles to as slow as 10 to 15 mph for MILES. Of course, this is in clear violation of Colorado Statutes. In the recent past, I have counted as many as 52 vehicles stacking up behind these different trucks that are apparently incapable of carrying their loads, yet nothing is done about it. It is much worse in the Spring and Summer. I am not against moving construction and commercial materials, but it has to be done responsibly. Since enforcement is unlikely, perhaps development of passing areas or mandatory truck turn outs would help? I have witnessed many instances of impatient drivers passing in dangerous situations all along the multi-mile NO PASSING areas of 83 to County Line Road (and well into Douglas County).
- (2) Hopefully all the curves will be opened up for better visibility by simply removing all trees within the full easements. Inattentive driving has gotten progressively worse, and vehicles are constantly lane drifting. This is much more concerning especially on the many curves from Old North Gate Road north and Stagecoach Road traveling south. Improving visibility on these curves will help approaching vehicles a better opportunity to see for what's ahead and some private driveways entering 83 are nearly blind.
- (3) Noise. Noise. Noise. While I would not advocate for any kind of noise wall, perhaps different materials could be used during asphalt repairs and overlays? General traffic is just loud, but add the mix of all the larger trucks to that their unlawful jake braking, bad exhaust systems, etc.
- (4) Improved Signage. Two recommendations here. (a) Improve the lane merge at North Gate Road. Extend the lane if possible, but add arrows on the pavement and additional signage that

the lane is ending! Traffic constantly continues in the outside lane , apparently oblivious that the lane is ending until it's upon them. This routinely creates a hazard for traffic in the inside lane. Indications that the lane is ending posted south of North Gate Road may help, along with pavement arrows directing vehicles over. (b) Signage needs to be added on 83 for northbound traffic as they near Hodgen/Baptist Road warning of stopped traffic. Sometimes traffic may be backed up and drivers need to prepare to stop. Approaching this intersection is generally safe with moderate traffic, however northbound traffic can get backed up at the signal light and is not visible until almost too late as drivers crest the slight ridge south of the intersection. I have seen many instances of vehicles serving off the roadway to avoid rear end collisions during the Spring and Summer and at high traffic times during the day.

- (5) I see the plan shows some possible improvement concerning Walden Way, but I am unsure how the U turn ability would solve the problem associated with both right and left access turns onto and off of 83. Deceleration/acceleration lanes at a minimum perhaps?

In response to your comment:

- (1) The purpose of the access study is to determine where access should be allowed on Highway 83. This study does not make recommendations for changing the design of the roadway, to include passing lanes. However, the Colorado Department of Transportation (CDOT) evaluates highways each year to determine the need for passing lanes. In fact, CDOT has plans for the addition of passing lanes on the highway in the future, which may address some of your concerns. It should be noted, CDOT recognizes the significant increase in traffic volumes on State Highway 83 as a result of the GAP project on I-25 and a 17% increase in Colorado's population since 2010. Several comments suggested that CDOT should restrict trucks on State Highway 83. State Statutes require that all state highways be open to truck traffic as the state highway system provides regional connectivity to various parts of the State. If trucks are restricted on State Highway, they will use more local and county roads.
- (2) CDOT recognizes that improving sight distance has the potential benefit of improving safety for highway travelers. Unfortunately, making recommendations to remove trees from the CDOT right-of-way is beyond the scope of the current project. CDOT has been made aware of your comments and will take them under advisement as they consider future project funding along the highway that may include removal of trees within CDOT right-of-way. It should be noted, many of the trees along the highway are located on private property and the removal of these trees by CDOT would not be possible without participation and cooperation by the landowners.
- (3) Engine compression brake devices, "Jake" brakes, reduce the load on foundation brakes, which helps prevent dangerous brake overheating. This keeps brakes available for emergencies. All commercial vehicles operating on any public roadway in Colorado equipped with an engine compression brake device are required by law to have mufflers. Even with proper use of mufflers, engine braking still produces a distinct sound. Because they are a safety device, the use of engine brakes is not prohibited on state highways. Prohibiting engine brakes would attempt to solve a noise problem without addressing the real cause, which is that some trucks have improperly muffled exhaust systems. CDOT does install signs stating "engine brake mufflers required" in our region IF the local authorities, County Sheriff or City Police commit to enforcement of the sign. As of this point the El Paso County Sheriff does not enforce such signs.

- (4) Again, your improved signage comments have value and will be taken into consideration by CDOT as future funding and projects are developed.
- (5) The Colorado Department of Transportation (CDOT) uses the proposed Access Control plan as one of many steps to improving highway safety. Reconfiguring access locations and providing proper auxiliary lanes is a key factor to improving the highway safety. This plan will be used to continually make highway improvements as new development occurs in this portion of El Paso County or as roadway projects emerge from State and County Planning efforts.

In summary:

- It is beyond the scope of this study to make the recommendation for changes in roadway design to include additional lanes, upgraded signage, passing lanes, and improved sight distance. However, all of your comments have merit and CDOT will give each additional consideration as they plan future projects along the highway.
- The highway must allow truck traffic and enforcement of trucks being equipped with engine brake mufflers is the responsibility of the local authorities, County Sheriff or City Police. As of this point the El Paso County Sheriff does not enforce such requirements along Highway 83.

Thanks again for your participation and comments. If you require additional communication from the project team, please do not hesitate to contact one of us.

Very Respectfully,

Valerie Vigil
Colorado Department of Transportation, Permits Manager
Valerie.Vigil@state.co.us

Victoria Chavez
El Paso County, Principal Transportation Planner
VictoriaChavez@elpasoco.com

Jennifer Irvine
El Paso County, County Engineer
JenniferIrvine@elpasoco.com

David Sprague, PE
Consultant Project Manager
David.Sprague@atkinsglobal.com

Dear Linda Famula,

The City of Colorado Springs, El Paso County (County), and the Colorado Department of Transportation (CDOT), would like to thank you for taking the time to participate in the Highway 83 Access Study virtual Open House that recently concluded in July of 2021. We appreciate the time you took to provide feedback and comments on the study. We assure you that we are considering your thoughts and making necessary adjustments to the study's recommendations in order to improve access, mobility, and safety for all users of Highway 83.

This study is a long-term plan. The majority of the recommendations that we have shown will not happen unless there's redevelopment of a property, major changes to the highway, or if multiple property owners and the County decide that they want to work together to create an alternative access—such as creating access to a future signal. Thus, if a property does not redevelop (i.e., experience a significant change in land use) it will continue to have access to the highway, although it may be restricted to something less than full movement in the future. Also, as traffic increases or a highway improvement project adds lanes, this plan provides guidance on where future traffic signals may be located. In addition, the plan provides opportunities for the creation of alternative access so that most adjacent properties would have direct access to Highway 83 at a signalized location, which will improve safety.

You provided the following comments/questions about the study:

- We moved here four years ago, and the volume of traffic has increased greatly. Within a matter of eight months, I have heard of three people getting killed on 83. The first accident on November 5, 2020, involved a stolen van crossing into oncoming traffic killing two people. High speed, reckless driving was shown to be the case with the driver. On June 29, 2021, a female driver in a truck got killed also crossing into oncoming traffic just south of North Gate Blvd hitting two other trucks and seriously injuring another driver. At least three times someone has headed toward me crossing illegally on 83 because they are too impatient. Has any consideration been given to putting up a guard rail in at least the "Expressway" section?
- That road cannot take the volume of traffic that now accesses it daily, and it's been made worse by the construction on I-25 travelling on Highway 83 instead of the interstate.
- Also, the traffic light at 83 to turn north & North Gate Blvd. seems unusually slow. I was wondering if it has been purposely made longer with the construction currently happening on North Gate Blvd? Cars behind you become impatient, and I'd hate to see someone try to turn left out of desperation. I also think the blinking yellow light at this intersection to turn onto North Gate Blvd. is dangerous.

In response to your comment:

- The purpose of the access study is to determine where access should be allowed on Highway 83. This study does not make recommendations for changing the design of the roadway, to include such items as guardrail to prevent center line crossover by vehicles. However, the Colorado Department of Transportation (CDOT) evaluates highways each year to determine the need for improvements to address safety and operational issues. The section of Highway 83 between Highway 21 and Old North Gate Road is considered an expressway. The addition of safety measures such as guardrail in the median is a possible solution to prevent future cross over

crashes. CDOT must give all highways segments within the region that have expressway designations with an equal level of consideration. From this, CDOT will develop a list of needed improvements and that list will be prioritized to develop a short- and long-range plan for highway improvement projects. Once the list is developed, CDOT must identify necessary funding to implement the appropriate improvements to eliminate or reduce the potential for further incidents.

- CDOT recognizes the significant increase in traffic volumes on State Highway 83 as a result of the GAP project on I-25 and a 17% increase in Colorado's population since 2010. The expectation is for traffic volumes to decrease upon the completion of the I-25 project and other improvements in the area such as the extension of Powers Boulevard to I-25. However, increased development along Highway 83 will continue to result in additional traffic using the highway. Development decisions and planning is not controlled by CDOT but is left to the local jurisdiction, in this case El Paso County.
- CDOT monitors traffic signals to ensure that they operate properly and adjusts the timing when an issue is identified. CDOT appreciates your comments and will investigate and adjust the timing if necessary. The flashing yellow arrow has been implemented across the state at numerous traffic signals because of the proven safety benefits that such a device brings to an intersection.

In summary:

- The purpose of the access study is to determine where access should be allowed on Highway 83. This study does not make recommendations for changing the design of the roadway, to include such items as guardrail to prevent center line crossover by vehicles. State Statutes require that all state highways be open to truck traffic as the state highway system provides regional connectivity to various parts of the State.

Thanks again for your participation and comments. If you require additional communication from the project team, please do not hesitate to contact one of us.

Very Respectfully,

Valerie Vigil
Colorado Department of Transportation, Permits Manager
Valerie.Vigil@state.co.us

Victoria Chavez
El Paso County, Principal Transportation Planner
VictoriaChavez@elpasoco.com

Jennifer Irvine
El Paso County, County Engineer
JenniferIrvine@elpasoco.com

David Sprague, PE
Consultant Project Manager
David.Sprague@atkinsglobal.com

Dear Robert and Linda Hutchinson,

The City of Colorado Springs, El Paso County (County), and the Colorado Department of Transportation (CDOT), would like to thank you for taking the time to participate in the Highway 83 Access Study virtual Open House that recently concluded in July of 2021. We appreciate the time you took to provide feedback and comments on the study. We assure you that we are considering your thoughts and making necessary adjustments to the study's recommendations in order to improve access, mobility, and safety for all users of Highway 83.

This study is a long-term plan. The majority of the recommendations that we have shown will not happen unless there's redevelopment of a property, major changes to the highway, or if multiple property owners and the County decide that they want to work together to create an alternative access—such as creating access to a future signal. Thus, if a property does not redevelop (i.e., experience a significant change in land use) it will continue to have access to the highway, although it may be restricted to something less than full movement in the future. Also, as traffic increases or a highway improvement project adds lanes, this plan provides guidance on where future traffic signals may be located. In addition, the plan provides opportunities for the creation of alternative access so that most adjacent properties would have direct access to Highway 83 at a signalized location, which will improve safety.

You provided the following comments/questions about the study:

- We are concerned about dividing our property and completely ruining it's monetary and aesthetic value. We do understand the need to address safety.
- The speed limit is too high.
- There are no driveway/shoulder turnouts.

In response to your comment:

- The current recommendations include closing your access (#38) only if Arena Road is realigned to pass through your property and connect with High Forest Road. This would require full cooperation from you to provide such easement for the roadway to pass through your property or you would have to sell your property so the future owner could put the roadway through. Should you decide against allowing such easement or if you do not sell your property, then your access (#38) will remain open.
- One of the most frequently heard complaints on this corridor is the speed of traffic. It's a common belief of the public's that lower speed limits are the solution to many crash and traffic problems. Studies have shown that most people will drive the speed at which they perceive the conditions to be safe and thus the Colorado State Statutes control how the speed limits are set on all public roadways. This Statute requires that speed limits shall not be higher or lower than the prima facie speed limits. Prima facie speed limits are those, which "at first appearance" are reasonable and prudent under normal roadway conditions. An appropriate, or "prima facia" speed limit will result in the maximum number of vehicles traveling at about the same speed, thus reducing conflicts caused by speed differentials. CDOT uses the 85th percentile speed, that speed at or below which 85% of the traffic is moving, as widely accepted as being closest to that "prima facia" speed limit.

- The purpose of the access study is to determine where access should be allowed on Highway 83. This study does not make recommendations for changing the design of the roadway, to include auxiliary turn lanes at driveways or intersections. However, the Colorado Department of Transportation (CDOT) evaluates highways each year to determine the need for improvements to address safety and operational issues. The Colorado Department of Transportation (CDOT) uses the proposed Access Control Plan as one of many steps to improving highway safety. Reconfiguring access locations and providing proper auxiliary lanes is a key factor to improving the highway safety. This plan will be used to continually make highway improvements as new development occurs in this portion of El Paso County or as roadway projects emerge from State and County Planning efforts.

In summary:

- The extension of Arena Road through your property would not occur without your willingness to provide the necessary easement for such a road, you sell your entire property, or your property redevelops.
- Your access may be restricted to less than full movement should a safety issue at your driveway arise, a roadway improvement project adds a median to the highway, or if you were to redevelop your property. All of this information is contained in the maps that were displayed during the meeting.
- CDOT uses the 85th percentile speed, that speed at or below which 85% of the traffic is moving, as widely accepted as being closest to that "prima facie" speed limit.
- The purpose of the access study is to determine where access should be allowed on Highway 83. This study does not make recommendations for changing the design of the roadway, to include auxiliary turn lanes at driveways/intersections, road widening, or realignment of the road to eliminate curves.

Thanks again for your participation and comments. If you require additional communication from the project team, please do not hesitate to contact one of us.

Very Respectfully,

Valerie Vigil
Colorado Department of Transportation, Permits Manager
Valerie.Vigil@state.co.us

Victoria Chavez
El Paso County, Principal Transportation Planner
VictoriaChavez@elspasoco.com

Jennifer Irvine
El Paso County, County Engineer
JenniferIrvine@elspasoco.com

David Sprague, PE
Consultant Project Manager
David.Sprague@atkinsglobal.com

Dear Shannon Baker,

The City of Colorado Springs, El Paso County (County), and the Colorado Department of Transportation (CDOT), would like to thank you for taking the time to participate in the Highway 83 Access Study virtual Open House that recently concluded in July of 2021. We appreciate the time you took to provide feedback and comments on the study. We assure you that we are considering your thoughts and making necessary adjustments to the study's recommendations in order to improve access, mobility, and safety for all users of Highway 83.

This study is a long-term plan. The majority of the recommendations that we have shown will not happen unless there's redevelopment of a property, major changes to the highway, or if multiple property owners and the County decide that they want to work together to create an alternative access—such as creating access to a future signal. Thus, if a property does not redevelop (significant change in land use) it will continue to have access to the highway, although it may be restricted to something less than full movement in the future. Also, as traffic increases or a highway improvement project adds lanes, this plan provides guidance on where future traffic signals may be located. In addition, the plan provides opportunities for the creation of alternative access so that most adjacent properties would have direct access to Highway 83 at a signalized location, which will improve safety.

You provided the following comments/questions about the study:

- I own property in Flying Horse (Encore Subdivision) that is alongside CO Highway 83 so am very interested in voicing a recommendation. Studying the information, at access point #6, it would be extremely beneficial to add access on the West side of 83 (at Shoop Road) to the massive dirt fill/landsite. This would provide a much better route for the many commercial dump trucks (regular dump trucks and the very large dirt haulers) to go in and out of this dirt pit off of CO 83 than coming through our residential Flying Horse neighborhoods. Our roads and roundabouts were not built to capacitate the weight and size of these haulers. This heavy commercial traffic is also very dangerous to our neighborhoods. We have families, children, pets, playing in the area (walking, biking, skateboarding) and it's a hazard. The trucks drive fast (we should have speed bumps to slow them down) and are extraordinarily loud. I have a neighbor that has tested the decibel levels of these trucks and he believes they exceed the allowed residential levels. These trucks have also damaged the roads, our beautiful roundabouts, the curbs, sidewalks and even street signs. If you were able to add a better access way for commercial dirt hauling equipment that would improve our residential safety and restore traffic patterns to roadway design specs, that would be extremely helpful. I'll directly quote a fellow neighbor of mine here, " Access point #6 is already a 3-way intersection with a traffic light, and looks to be immediately adjacent to the fill dirt park via a portion of land currently owned or controlled by the State of Colorado".

In response to your comment:

- Although the property west of Highway 83, at Shoop Road, is owned by CDOT, CDOT does not develop local roadways. The development of an additional leg to this intersection that would go west would need to be a local project done by either a developer or the County. At the current time there are no plans to add a fourth leg to the Shoop Road intersection. In addition, the

properly west of Highway 83 has a significant drainage easement that would significantly increase the cost and difficulty in adding a roadway to this property.

In summary:

- Shoup Road will remain a three-leg intersection.

Thanks again for your participation and comments. If you require additional communication from the project team, please do not hesitate to contact one of us.

Very Respectfully,

Valerie Vigil

Colorado Department of Transportation, Permits Manager

Valerie.Vigil@state.co.us

Victoria Chavez

El Paso County, Principal Transportation Planner

VictoriaChavez@elpasoco.com

Jennifer Irvine

El Paso County, County Engineer

JenniferIrvine@elpasoco.com

David Sprague, PE

Consultant Project Manager

David.Sprague@atkinsglobal.com

Dear Susan Gindhart,

The City of Colorado Springs, El Paso County (County), and the Colorado Department of Transportation (CDOT), would like to thank you for taking the time to participate in the Highway 83 Access Study virtual Open House that recently concluded in July of 2021. We appreciate the time you took to provide feedback and comments on the study. We assure you that we are considering your thoughts and making necessary adjustments to the study's recommendations in order to improve access, mobility, and safety for all users of Highway 83.

This study is a long-term plan. The majority of the recommendations that we have shown will not happen unless there's redevelopment of a property, major changes to the highway, or if multiple property owners and the County decide that they want to work together to create an alternative access—such as creating access to a future signal. Thus, if a property does not redevelop (i.e., experience a significant change in land use) it will continue to have access to the highway, although it may be restricted to something less than full movement in the future. Also, as traffic increases or a highway improvement project adds lanes, this plan provides guidance on where future traffic signals may be located. In addition, the plan provides opportunities for the creation of alternative access so that most adjacent properties would have direct access to Highway 83 at a signalized location, which will improve safety.

You provided the following comments/questions about the study:

- I believe those homes with driveways directly off of 83 may be benefited by a shared drive, however, there is no reason for shared drive to my parcel. I access off of Outlook and then Kaessner (at mile marker 24) to get to 83. Don't understand the reasoning to appoint a shared drive from the back of my property when my drive is right off of Outlook. Who do you expect to pay for extending driveways and accessing and maintaining such long driveways? There is also confrontations when sharing drives as to whose expense it is.
- Highway 83 is a real mess especially when traffic is diverted off from I-25 or in the case of the Black Forest fire, as this is the alternate route. It would be helpful to make turn lanes into the already established roadways off of 83. People ride your tail when trying to turn. I could see recommending shared drives for those that are only single driveways directly off of 83, but otherwise it will pose additional problems. Are additional lanes being planned?
- The highway needs to be widened - it is heavily used, and we've seen more and more accidents. This is the alternate route when I-25 is closed or when there is a football game. It gets very congested and is harder to get out of Kaessner (access 25) just to make a right turn because of the heavy traffic. A much-needed traffic light would be beneficial with warning signals prior to the light in both directions.

In response to your comment:

- The shared access on the back of your property is shown in the plan for the purpose of providing options should the adjacent properties redevelop. During the redevelopment process all access options will be investigated and that may include the ability to work with you or the future owner of your property to gain access to Outlook Drive and eventually Kaessner Lane to an intersection with a potential traffic signal. If redevelopment does not occur, then this shared access will not occur. In addition, as long as you own your property and do not prefer to allow

any shared access through your property, then such access will not happen. It should be noted that if and when any shared access is constructed it would be at the expense of the property owners that share the access.

- The purpose of the access study is to determine where access should be allowed on Highway 83. This study does not make recommendations for changing the design of the roadway, to include auxiliary turn lanes at driveways/intersections or for widening the roadway. However, the Colorado Department of Transportation (CDOT) evaluates highways each year to determine the need for improvements to address safety and operational issues. The Colorado Department of Transportation (CDOT) uses the proposed Access Control plan as one of many steps to improving highway safety. Reconfiguring access locations and providing proper auxiliary lanes is a key factor to improving the highway safety. This plan will be used to continually make highway improvements as new development occurs in this portion of El Paso County or as roadway projects emerge from State and County Planning efforts.
- The plan does show that a future traffic signal may be added at the Kaessner Lane intersection and that a new roadway may be constructed on the east side of Highway 83 to align with Kaessner Lane. However, a traffic signal will only be installed if the intersection experiences poor traffic operations, there is a safety issue that can be corrected through the addition of adding a traffic signal, or if a traffic study is performed that indicates a traffic signal is warranted.

In summary:

- Shared access locations are intended to provide options for future property owners should redevelopment occur, or the need arise to provide options in gaining access to Highway 83. As long as you continue to own your property and have no desire to allow such shared access then it will not happen.
- The purpose of the access study is to determine where access should be allowed on Highway 83. This study does not make recommendations for changing the design of the roadway, to include auxiliary turn lanes at driveways/intersections or for widening the roadway.
- A traffic signal will only be installed if the intersection experiences poor traffic operations, there is a safety issue that can be corrected through the addition of adding a traffic signal, or if a traffic study is performed that indicates a traffic signal is warranted.

Thanks again for your participation and comments. If you require additional communication from the project team, please do not hesitate to contact one of us.

Very Respectfully,

Valerie Vigil
Colorado Department of Transportation, Permits Manager
Valerie.Vigil@state.co.us

Victoria Chavez
El Paso County, Principal Transportation Planner
VictoriaChavez@elspasoco.com

Jennifer Irvine
El Paso County, County Engineer

JenniferIrvine@elspasoco.com

David Sprague, PE

Consultant Project Manager

David.Sprague@atkinsglobal.com

E.5. Presentation to Elected Officials

**PROJECT SUMMARY
PRESENTATION
AUGUST 18, 2021**

The purpose/goal of access control

- Recommend a long-range plan for ultimate access conditions that address existing spacing deficiencies
- Provide adequate access to adjacent properties while better utilizing the local roadway system
- Improve mobility while considering safety for all users
- Enhance the highway aesthetics to improve the overall experience of those that reside in the area, visitors, and those conducting business
- Provide the County, City, and CDOT with a tool to help:
 - Make access decisions during development and/or redevelopment
 - Streamline the access permitting process

The access control plan was developed by the Colorado Department of Transportation in collaboration with El Paso County and the City of Colorado Springs.

How the plan was developed

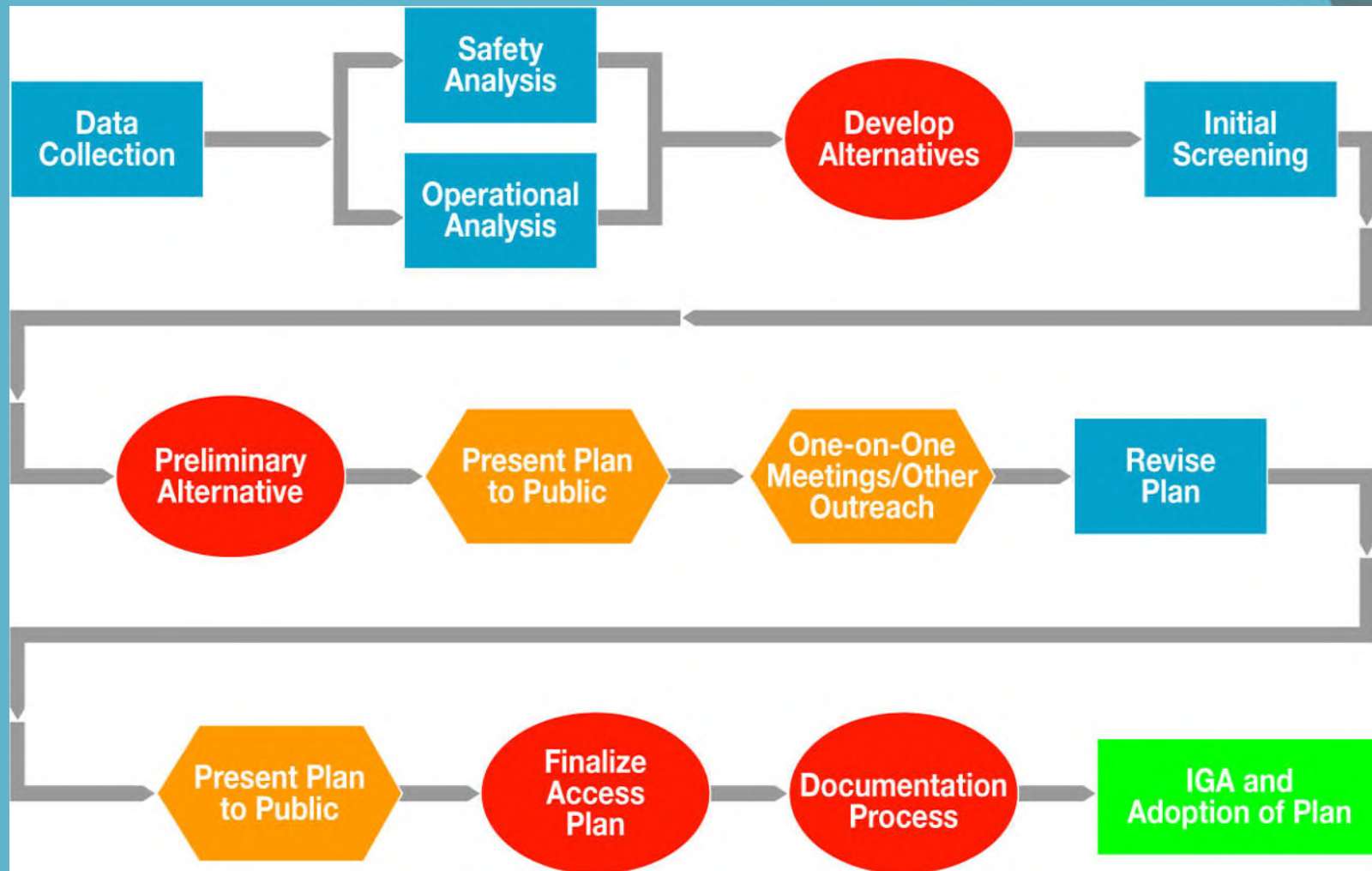

Existing access conditions

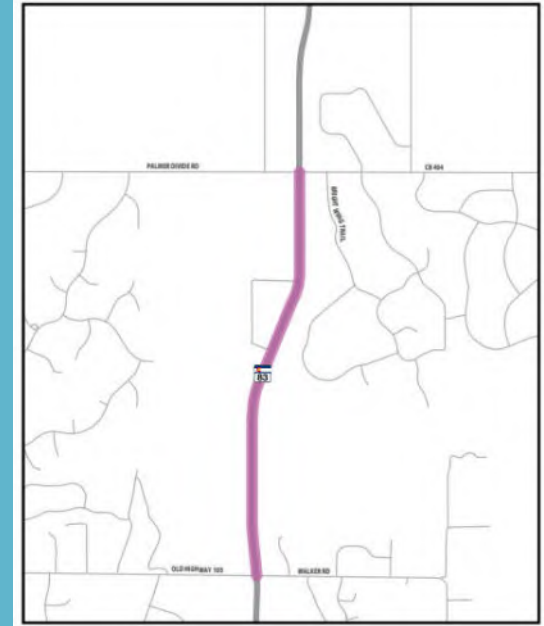

- Study Limits: CO 83 between Powers Boulevard (CO 21) and County Line Road (Palmer Divide Road) or 9.85 miles
- Contains 72 individual access locations (driveways, field accesses, curb cuts, roads)
 - 30% public streets and 70% private driveways
- Most access locations allow full movement (no turn restrictions)

Access categories

- Expressway (Powers Blvd to Old North Gate Rd)
 - Focus on traffic mobility over access to properties
 - Direct access only if alternate is not available
 - Signals spaced at least ½ mile apart
- Regional Highway (Old North Gate Road to County Line Road)
 - Focus on traffic mobility
 - Low priority for direct access to adjacent properties
 - Signals spaced at least ½ mile apart

Safety conditions

- Crashes from 12/31/14 to 12/31/19 (CDOT data for reported crashes)
- 333 crash events involving vehicles
 - No pedestrian or bicycle crashes
 - 1 fatality between Flying Horse Club Drive and North Gate Boulevard

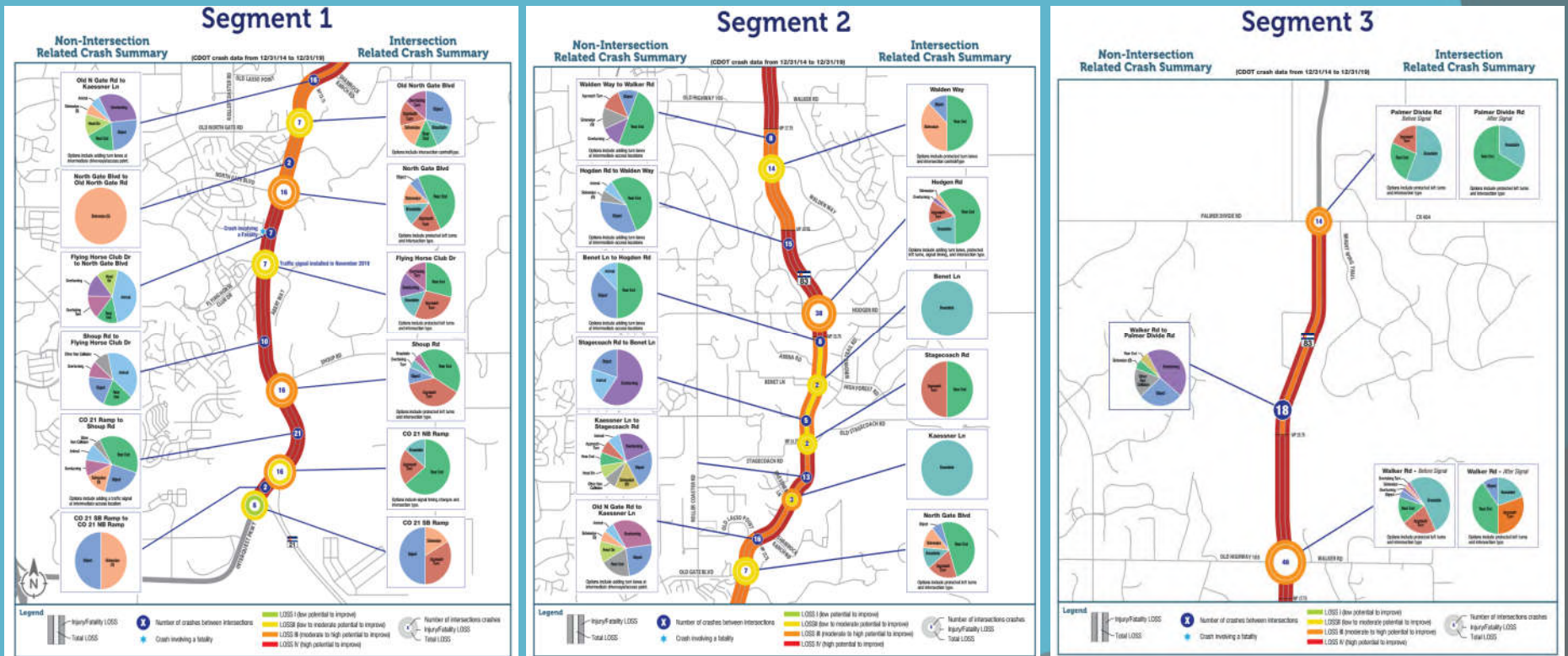

Safety conditions

- Look for crashes that are typically a result of access conditions and identify solutions (For example - broadside, approach turn, rear end, and head-on)
- Some crashes are not a result of access conditions and should be addressed outside the ACP process (For example – animal, object, and overturning)
- Most intersections have a low to moderate potential for safety improvements
- In between intersections, the highway sections typically have a moderate to high potential for safety improvements
- Future safety improvements should be made in line with the recommendations of the ACP
- Traffic growth without access control may result in an increase in the frequency and severity of crashes on CO 83
- Optimization of the number and type of accesses will reduce the number of conflict points and improve safety

Mobility conditions

- Eight intersections in the project limits with existing traffic signals all operate acceptably
- Unsignalized intersections operate acceptably
 - Some difficulty for vehicles attempting to turn onto CO 83 from the side street approaches
- Existing traffic operations are considered good overall
 - No need for immediate changes
 - Conditions are likely to degrade as development occurs and traffic volumes increase
- Future analysis without access control indicates
 - Many intersections will fail
 - Vehicles on side streets will face increased difficulty entering the highway
 - Overall mobility for vehicles will deteriorate
- Supports the need to consider optimizing the number, location, and design of access points on CO 83 for the long term

Develop alternatives

- Methods to optimize access
- Consider current and future development and their access needs
- Consider possible future highway improvement projects
- Look at appropriate spacing of full movement intersections (potential for signals)

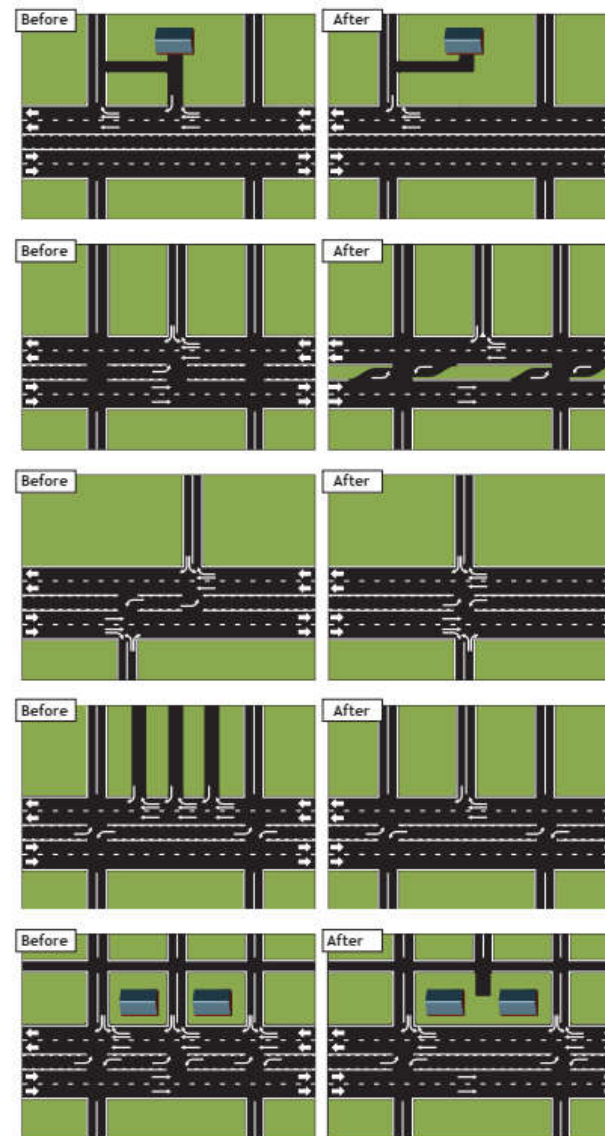

Use Local Streets

- Access to local properties through secondary roads
- Consolidate number of access locations where vehicles may enter or exit the highway
- Reduces the number of conflict points

Addition of Median Treatment

- Limit turning movements to locations with a dedicated left turn lane
- Reduces the number of conflicts between left turning vehicles and through vehicles on the highway

Realignment

- Align opposite approaches
- Creates a more familiar intersection design

Consolidation

- Consolidate adjacent access points into fewer locations
- The number of conflict points are reduced

Alternate Access Route

- Provide access to properties via an improved/new alternate access road
- Reduces the number of access points along the highway

Stakeholder/public outreach efforts

- Monthly project team meetings
 - CDOT, County, and City staff invited to participate
- Conducted two virtual open houses
 - February 2021
 - Present draft plan, receive input from public
 - June 2021
 - Present final plan
 - Received total of 44 comments from public
- One-on-one meetings with property owners
 - Conducted a total of 6 meetings with citizens

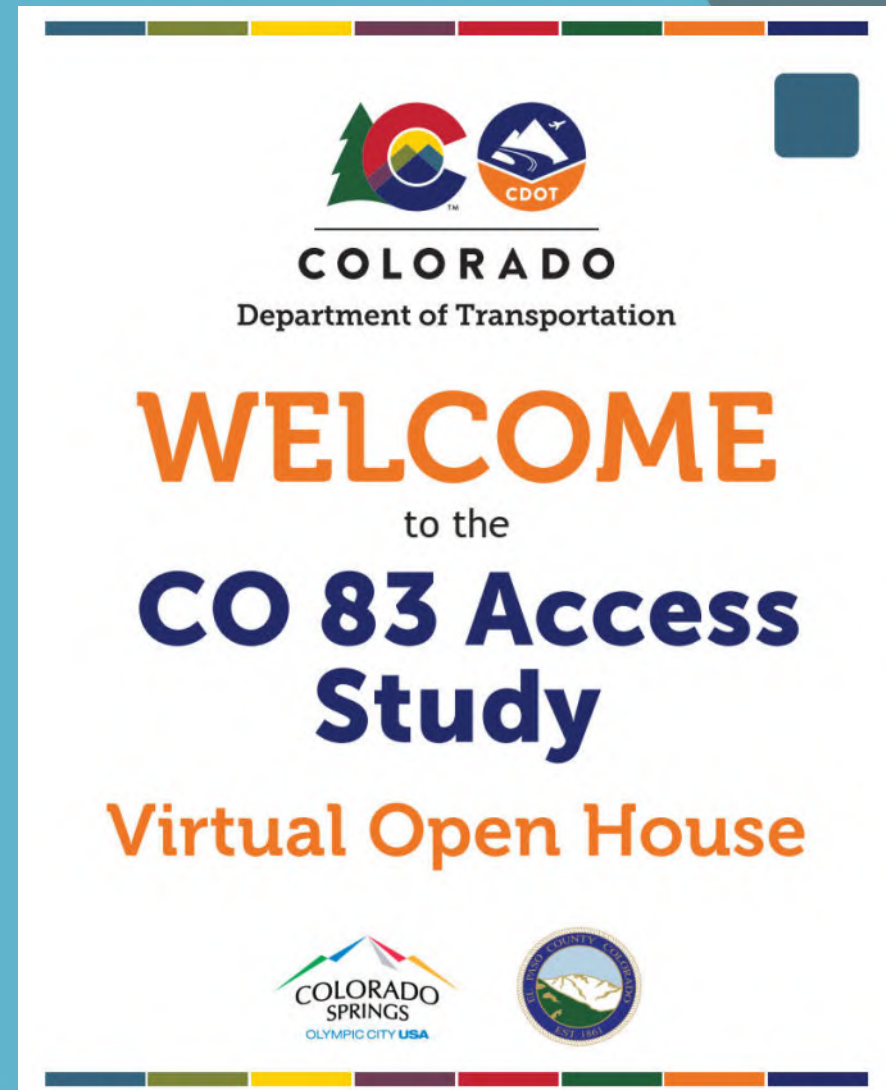

Public comment concerns

- Speed of vehicles
- Noise from large trucks
- Number of large trucks and volume of traffic overall
- Posted speed limit
- Lack of turn lanes
- Safety in the area around the newly constructed Stagecoach Road intersection
- Need for more traffic signals
- Sight distance through curves
- How does process to have shared access work

What the final plan does

- Create a long term (2045 and beyond) plan for access
- Optimize the location, number, and type of access in order to help promote safety and mobility (along and across CO 83)
- Support the long-term plans for CO 83
- Provide the appropriate level of access to adjacent properties
- Meet the requirements of the State Highway Access Code
- Address concerns raised by stakeholders
- Outline the conditions that must be satisfied before a change in access will occur (see example on next slide)

The final plan does not

- Identify specific projects
- Establish a timeline for when changes will occur
- Include design details (such as turn lanes) of potential access, mobility, safety, or capacity improvements within the project limits (done as part of future projects/studies)
- Preclude current projects planned for CO 83 including future widening
- Prohibit future amendments to the plan's final recommendations
- Preclude future development or redevelopment along CO 83

Conditions that must be satisfied for changes to occur

Access Control Plan Table^{1, 2}

Colorado State Highway 83 (El Paso County)

August 5, 2021

Access # (Map #)	Milepost ³	Side of Road	Access Description	Existing Land Use	Existing Configuration	Ultimate Configuration	Notes/Conditions for Change ⁴
11 (4)	22.946	East	Private Driveway	Rural Residential	Full movement (un-signalized)	Closed	<p>Access may be restricted to right-in, right-out or ¾ movement if:</p> <ul style="list-style-type: none"> Adequate improvements have been made to ensure U-turns can be safely completed at nearby intersections, and The adjacent property(ies) redevelops; or An operational and/or safety issues are identified through the completion of a traffic study, or As part of roadway improvement project that adds capacity or a median to CO 83. <p>Access will be closed if:</p> <ul style="list-style-type: none"> A cross access easement is obtained with adjacent property(ies); and Internal connectivity to/from Access #9 or Access #13 is developed.
Milepost 23							
12 (4)	23.124	West	Old North Gate Road	Transportation (Public Roadway)	Full movement (un-signalized)	Full Movement⁵	Access design may be changed to better accommodate U-turns if nearby accesses are restricted to less than full movement.
13 (4)	23.131	East	Private Driveway	Rural Residential	Full movement (un-signalized)	Full Movement⁵	Access design may be changed to better accommodate U-turns if nearby accesses are restricted to less than full movement.

- The current State Highway Access Code shall govern any unresolved discrepancies regarding access decisions.
- All access points are subject to consolidation upon the combining or subdividing of any lots under a single ownership or controlling interest.
- All access locations +/- 50 feet (0.01 mile) unless otherwise noted.
- The type, number, and storage length of lanes may be determined by a separate traffic study to be completed at the time of the actual design and implementation of the access plan and to ensure that the design does not create operational and/or safety issues.
- Full movement access with potential to become/remains signalized or change to other full movement control, such as a roundabout. The design of any intermediate/final intersection control changes will be completed under a separate study to ensure that the design complies with the recommendations of the access control plan and does not create operational and/or safety issues.
- A 3/4 movement configuration means that vehicles can turn right into the access, turn right out of the access, and turn left into the access.

Implementation of the plan

- Phased approach (will not occur as a single project)
 - The plan represents a long-range vision for the highway
 - Currently, there is no identified state or federal funding to implement the improvements
 - There are no identified projects to implement the plan's full recommendations
- Triggers for implementation include:
 - Traffic operational issues
 - Increase in safety concerns
 - As a result of a roadway improvement project
 - Part of the development or redevelopment process

Next steps

- Adopt/sign Intergovernmental Agreement (IGA) between County and CDOT
- Provide County and CDOT with project documentation
- Coordination between the County and CDOT to ensure proper implementation of the plan
- Amend the plan in the future if conditions change, unexpected development occurs, future projects occur, or better solutions are identified

ACCESS STUDY PROCESS



**THANK YOU
QUESTIONS?**

Final Plan Recommendations

CO 83 ACCESS STUDY



CO-83 Access Control Plan Page 1 of 14

0 200 400 800 Feet

Legend

- | | | | |
|--|--|--|--|
| | Milepoints | | Right-In, Right-Out |
| | Parcels | | Emergency Access Only |
| | Full Movement (Signalized or Potential Roundabout) | | Right-In Only |
| | Full Movement (Unsignalized) | | Proposed Cross/Shared Property Access* |
| | Access Closed | | Existing Cross/Shared Property Access* |
| | 3/4 Movement (No Left Out) | | Proposed Future Roadway |

Notes

1. The current State Highway Access Code shall govern any unresolved discrepancies regarding access decisions.
 2. All access points are subject to consolidation upon the combining or subdividing of any lots under a single ownership or controlling interest.
 3. All access locations +/- 50 feet (0.01 mile) unless otherwise noted.
 4. The type, number, and storage length of lanes may be determined by a separate traffic study to be completed at the time of the actual design and implementation of the access plan and to ensure that the design does not create operational and/or safety issues.
 5. Full movement access with potential to become/remain signalized or change to other full movement control, such as a roundabout. The design of any intermediate/final intersection control changes will be completed under a separate study to ensure that the design complies with the recommendations of the access control plan and does not create operational and/or safety issues.
 6. A 3/4 movement configuration means that vehicles can turn right into the access, turn right out of the access, and turn left into the access.
- *Arrows represent two properties that already have shared access or could have shared access in the future. The placement of the arrows in the figure are not meant to identify the location of any future shared access. The location of future shared access would be determined through a cooperative and public effort between the property owners and/or CDOT and the County.

CO 83 ACCESS STUDY



CO-83 Access Control Plan Page 2 of 14

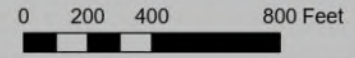

Legend

- | | | | |
|--|--|--|--|
| | Milepoints | | Right-In, Right-Out |
| | Parcels | | Emergency Access Only |
| | Full Movement (Signalized or Potential Roundabout) | | Right-In Only |
| | Full Movement (Unsignalized) | | Proposed Cross/Shared Property Access* |
| | Access Closed | | Existing Cross/Shared Property Access* |
| | 3/4 Movement (No Left Out) | | Proposed Future Roadway |

Notes

1. The current State Highway Access Code shall govern any unresolved discrepancies regarding access decisions.
 2. All access points are subject to consolidation upon the combining or subdividing of any lots under a single ownership or controlling interest.
 3. All access locations +/- 50 feet (0.01 mile) unless otherwise noted.
 4. The type, number, and storage length of lanes may be determined by a separate traffic study to be completed at the time of the actual design and implementation of the access plan and to ensure that the design does not create operational and/or safety issues.
 5. Full movement access with potential to become/remains signalized or change to other full movement control, such as a roundabout. The design of any intermediate/final intersection control changes will be completed under a separate study to ensure that the design complies with the recommendations of the access control plan and does not create operational and/or safety issues.
 6. A 3/4 movement configuration means that vehicles can turn right into the access, turn right out of the access, and turn left into the access.
- *Arrows represent two properties that already have shared access or could have shared access in the future. The placement of the arrows in the figure are not meant to identify the location of any future shared access. The location of future shared access would be determined through a cooperative and public effort between the property owners and/or CDOT and the County.

CO 83 ACCESS STUDY



CO-83 Access Control Plan Page 3 of 14

0 200 400 800 Feet

Legend

- | | | | |
|--|--|--|--|
| | Milepoints | | Right-In, Right-Out |
| | Parcels | | Emergency Access Only |
| | Full Movement (Signalized or Potential Roundabout) | | Right-In Only |
| | Full Movement (Unsignalized) | | Proposed Cross/Shared Property Access* |
| | Access Closed | | Existing Cross/Shared Property Access* |
| | 3/4 Movement (No Left Out) | | Proposed Future Roadway |

Notes

- The current State Highway Access Code shall govern any unresolved discrepancies regarding access decisions.
 - All access points are subject to consolidation upon the combining or subdividing of any lots under a single ownership or controlling interest.
 - All access locations +/- 50 feet (0.01 mile) unless otherwise noted.
 - The type, number, and storage length of lanes may be determined by a separate traffic study to be completed at the time of the actual design and implementation of the access plan and to ensure that the design does not create operational and/or safety issues.
 - Full movement access with potential to become/remain signalized or change to other full movement control, such as a roundabout. The design of any intermediate/final intersection control changes will be completed under a separate study to ensure that the design complies with the recommendations of the access control plan and does not create operational and/or safety issues.
 - A 3/4 movement configuration means that vehicles can turn right into the access, turn right out of the access, and turn left into the access.
- *Arrows represent two properties that already have shared access or could have shared access in the future. The placement of the arrows in the figure are not meant to identify the location of any future shared access. The location of future shared access would be determined through a cooperative and public effort between the property owners and/or CDOT and the County.

CO 83 ACCESS STUDY



CO-83 Access Control Plan Page 4 of 14

0 200 400 800 Feet

Legend

- | | | | |
|--|--|--|--|
| | Milepoints | | Right-In, Right-Out |
| | Parcels | | Emergency Access Only |
| | Full Movement (Signalized or Potential Roundabout) | | Right-In Only |
| | Full Movement (Unsignalized) | | Proposed Cross/Shared Property Access* |
| | Access Closed | | Existing Cross/Shared Property Access* |
| | 3/4 Movement (No Left Out) | | Proposed Future Roadway |

Notes

1. The current State Highway Access Code shall govern any unresolved discrepancies regarding access decisions.
 2. All access points are subject to consolidation upon the combining or subdividing of any lots under a single ownership or controlling interest.
 3. All access locations +/- 50 feet (0.01 mile) unless otherwise noted.
 4. The type, number, and storage length of lanes may be determined by a separate traffic study to be completed at the time of the actual design and implementation of the access plan and to ensure that the design does not create operational and/or safety issues.
 5. Full movement access with potential to become/remain signalized or change to other full movement control, such as a roundabout. The design of any intermediate/final intersection control changes will be completed under a separate study to ensure that the design complies with the recommendations of the access control plan and does not create operational and/or safety issues.
 6. A 3/4 movement configuration means that vehicles can turn right into the access, turn right out of the access, and turn left into the access.
- *Arrows represent two properties that already have shared access or could have shared access in the future. The placement of the arrows in the figure are not meant to identify the location of any future shared access. The location of future shared access would be determined through a cooperative and public effort between the property owners and/or CDOT and the County.

CO 83 ACCESS STUDY

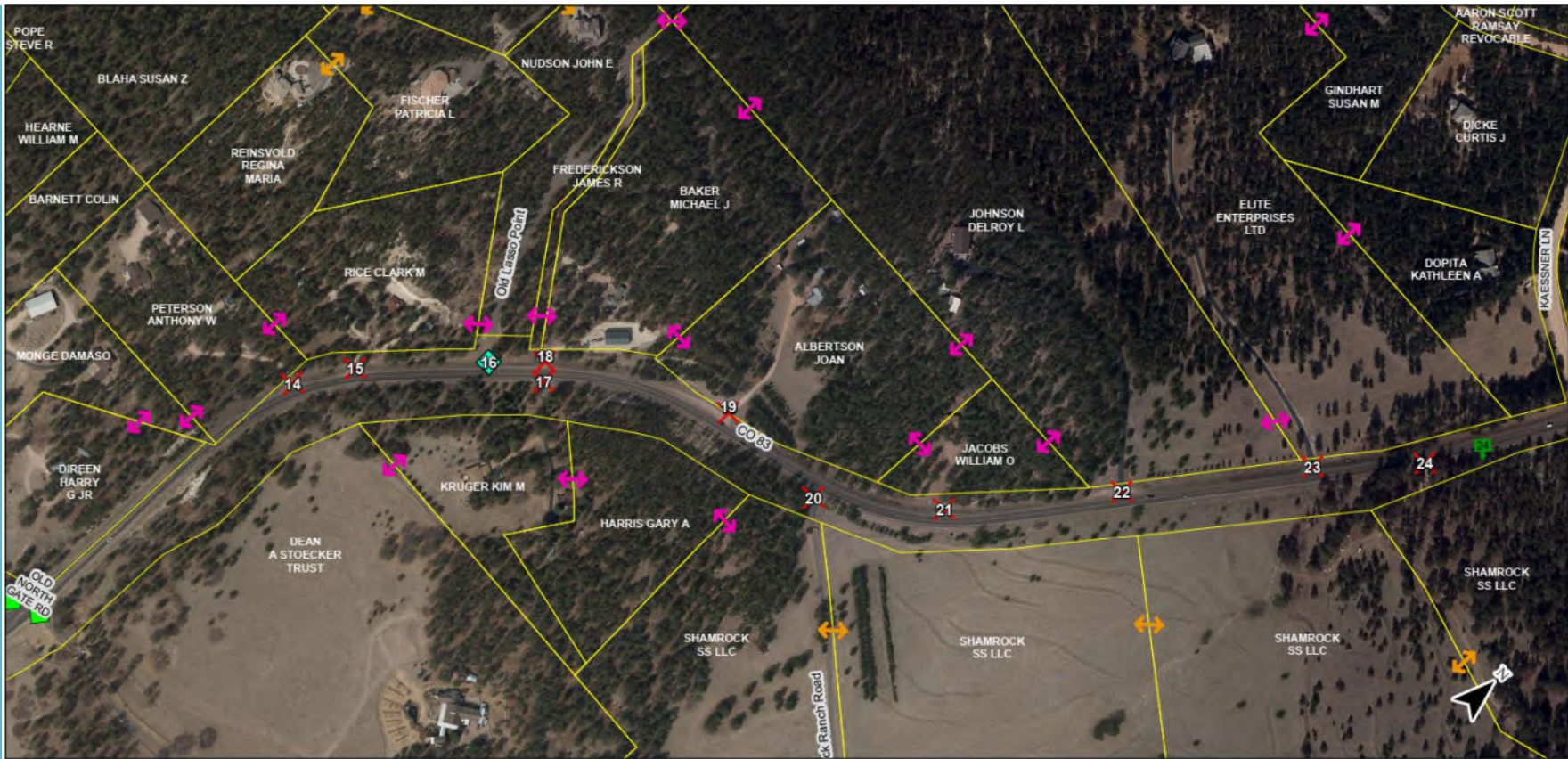

CO-83 Access Control Plan Page 5 of 14

0 200 400 800 Feet

Legend

- | | | | |
|--|--|--|--|
| | Milepoints | | Right-In, Right-Out |
| | Parcels | | Emergency Access Only |
| | Full Movement (Signalized or Potential Roundabout) | | Right-In Only |
| | Full Movement (Unsignalized) | | Proposed Cross/Shared Property Access* |
| | Access Closed | | Existing Cross/Shared Property Access* |
| | 3/4 Movement (No Left Out) | | Proposed Future Roadway |

Notes

1. The current State Highway Access Code shall govern any unresolved discrepancies regarding access decisions.
 2. All access points are subject to consolidation upon the combining or subdividing of any lots under a single ownership or controlling interest.
 3. All access locations +/- 50 feet (0.01 mile) unless otherwise noted.
 4. The type, number, and storage length of lanes may be determined by a separate traffic study to be completed at the time of the actual design and implementation of the access plan and to ensure that the design does not create operational and/or safety issues.
 5. Full movement access with potential to become/remain signalized or change to other full movement control, such as a roundabout. The design of any intermediate/final intersection control changes will be completed under a separate study to ensure that the design complies with the recommendations of the access control plan and does not create operational and/or safety issues.
 6. A 3/4 movement configuration means that vehicles can turn right into the access, turn right out of the access, and turn left into the access.
- *Arrows represent two properties that already have shared access or could have shared access in the future. The placement of the arrows in the figure are not meant to identify the location of any future shared access. The location of future shared access would be determined through a cooperative and public effort between the property owners and/or CDOT and the County.

CO 83 ACCESS STUDY

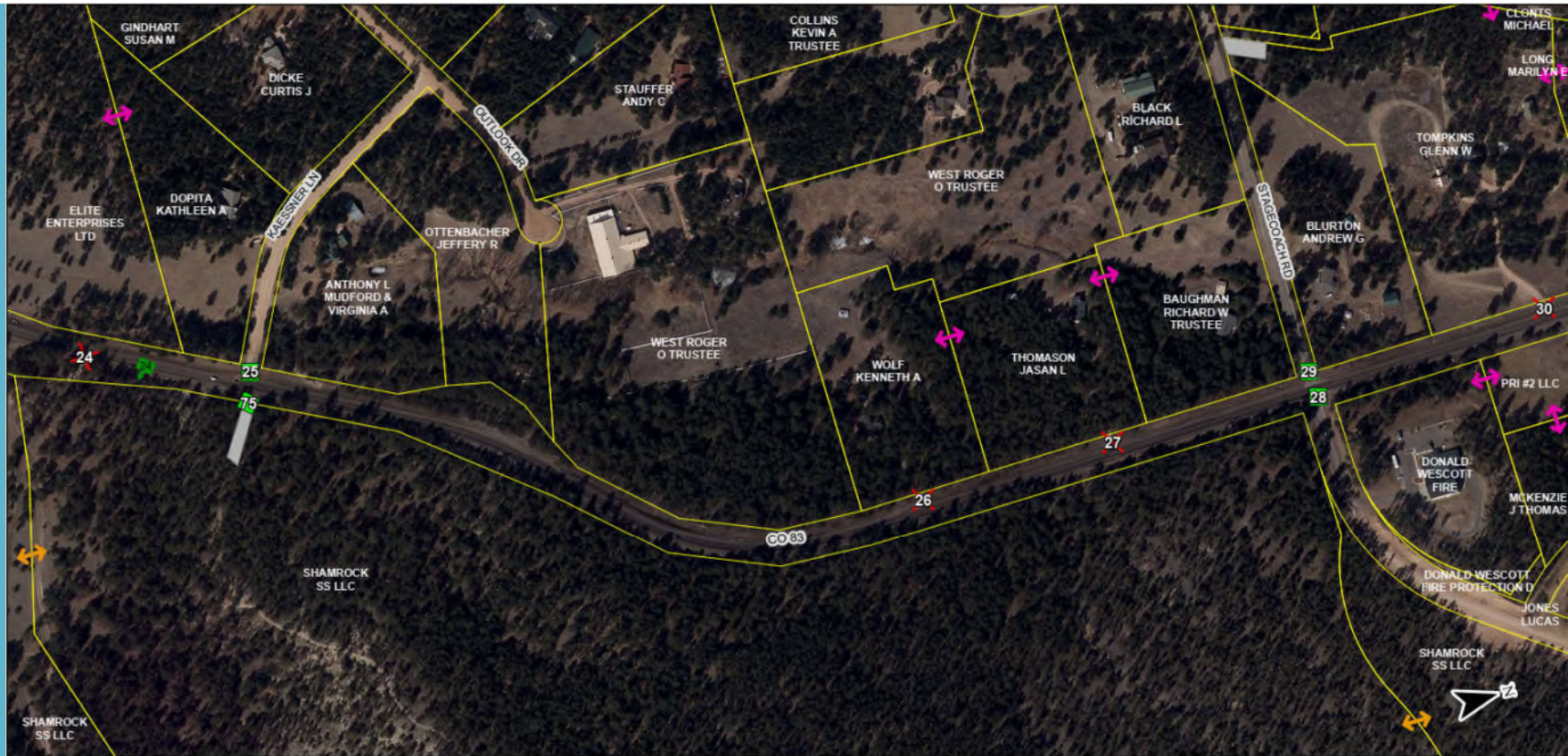

CO-83 Access Control Plan Page 6 of 14

0 200 400 800 Feet

Legend

- | | | | |
|--|--|--|--|
| | Milepoints | | Right-In, Right-Out |
| | Parcels | | Emergency Access Only |
| | Full Movement (Signalized or Potential Roundabout) | | Right-In Only |
| | Full Movement (Unsignalized) | | Proposed Cross/Shared Property Access* |
| | Access Closed | | Existing Cross/Shared Property Access* |
| | 3/4 Movement (No Left Out) | | Proposed Future Roadway |

Notes

1. The current State Highway Access Code shall govern any unresolved discrepancies regarding access decisions.
 2. All access points are subject to consolidation upon the combining or subdividing of any lots under a single ownership or controlling interest.
 3. All access locations +/- 50 feet (0.01 mile) unless otherwise noted.
 4. The type, number, and storage length of lanes may be determined by a separate traffic study to be completed at the time of the actual design and implementation of the access plan and to ensure that the design does not create operational and/or safety issues.
 5. Full movement access with potential to become/remain signalized or change to other full movement control, such as a roundabout. The design of any intermediate/final intersection control changes will be completed under a separate study to ensure that the design complies with the recommendations of the access control plan and does not create operational and/or safety issues.
 6. A 3/4 movement configuration means that vehicles can turn right into the access, turn right out of the access, and turn left into the access.
- *Arrows represent two properties that already have shared access or could have shared access in the future. The placement of the arrows in the figure are not meant to identify the location of any future shared access. The location of future shared access would be determined through a cooperative and public effort between the property owners and/or CDOT and the County.

CO 83 ACCESS STUDY



CO-83 Access Control Plan Page 7 of 14

0 200 400 800 Feet

Legend

- | | | | |
|--|--|--|--|
| | Milepoints | | Right-In, Right-Out |
| | Parcels | | Emergency Access Only |
| | Full Movement (Signalized or Potential Roundabout) | | Right-In Only |
| | Full Movement (Unsignalized) | | Proposed Cross/Shared Property Access* |
| | Access Closed | | Existing Cross/Shared Property Access* |
| | 3/4 Movement (No Left Out) | | Proposed Future Roadway |

Notes

1. The current State Highway Access Code shall govern any unresolved discrepancies regarding access decisions.
 2. All access points are subject to consolidation upon the combining or subdividing of any lots under a single ownership or controlling interest.
 3. All access locations +/- 50 feet (0.01 mile) unless otherwise noted.
 4. The type, number, and storage length of lanes may be determined by a separate traffic study to be completed at the time of the actual design and implementation of the access plan and to ensure that the design does not create operational and/or safety issues.
 5. Full movement access with potential to become/remain signalized or change to other full movement control, such as a roundabout. The design of any intermediate/final intersection control changes will be completed under a separate study to ensure that the design complies with the recommendations of the access control plan and does not create operational and/or safety issues.
 6. A 3/4 movement configuration means that vehicles can turn right into the access, turn right out of the access, and turn left into the access.
- *Arrows represent two properties that already have shared access or could have shared access in the future. The placement of the arrows in the figure are not meant to identify the location of any future shared access. The location of future shared access would be determined through a cooperative and public effort between the property owners and/or CDOT and the County.

CO 83 ACCESS STUDY



CO-83 Access Control Plan Page 8 of 14

0 200 400 800 Feet

Legend

- | | | | |
|--|--|--|--|
| | Milepoints | | Right-In, Right-Out |
| | Parcels | | Emergency Access Only |
| | Full Movement (Signalized or Potential Roundabout) | | Right-In Only |
| | Full Movement (Unsignalized) | | Proposed Cross/Shared Property Access* |
| | Access Closed | | Existing Cross/Shared Property Access* |
| | 3/4 Movement (No Left Out) | | Proposed Future Roadway |

Notes

1. The current State Highway Access Code shall govern any unresolved discrepancies regarding access decisions.
 2. All access points are subject to consolidation upon the combining or subdividing of any lots under a single ownership or controlling interest.
 3. All access locations +/- 50 feet (0.01 mile) unless otherwise noted.
 4. The type, number, and storage length of lanes may be determined by a separate traffic study to be completed at the time of the actual design and implementation of the access plan and to ensure that the design does not create operational and/or safety issues.
 5. Full movement access with potential to become/remainsignalized or change to other full movement control, such as a roundabout. The design of any intermediate/final intersection control changes will be completed upon a separate study to ensure that the design complies with the recommendations of the access control plan and does not create operational and/or safety issues.
 6. A 3/4 movement configuration means that vehicles can turn right into the access, turn right out of the access, and turn left into the access.
- *Arrows represent two properties that already have shared access or could have shared access in the future. The placement of the arrows in the figure are not meant to identify the location of any future shared access. The location of future shared access would be determined through a cooperative and public effort between the property owners and/or CDOT and the County.

CO 83 ACCESS STUDY



CO-83 Access Control Plan Page 9 of 14

0 200 400 800 Feet

Legend

	Milepoints		Right-In, Right-Out
	Parcels		Emergency Access Only
	Full Movement (Signalized or Potential Roundabout)		Right-In Only
	Full Movement (Unsignalized)		Proposed Cross/Shared Property Access*
	Access Closed		Existing Cross/Shared Property Access*
	3/4 Movement (No Left Out)		Proposed Future Roadway

Notes

1. The current State Highway Access Code shall govern any unresolved discrepancies regarding access decisions.
 2. All access points are subject to consolidation upon the combining or subdividing of any lots under a single ownership or controlling interest.
 3. All access locations +/- 50 feet (0.01 mile) unless otherwise noted.
 4. The type, number, and storage length of lanes may be determined by a separate traffic study to be completed at the time of the actual design and implementation of the access plan and to ensure that the design does not create operational and/or safety issues.
 5. Full movement access with potential to become/remain signalized or change to other full movement control, such as a roundabout. The design of any intermediate/final intersection control changes will be completed under a separate study to ensure that the design complies with the recommendations of the access control plan and does not create operational and/or safety issues.
 6. A 3/4 movement configuration means that vehicles can turn right into the access, turn right out of the access, and turn left into the access.
- *Arrows represent two properties that already have shared access or could have shared access in the future. The placement of the arrows in the figure are not meant to identify the location of any future shared access. The location of future shared access would be determined through a cooperative and public effort between the property owners and/or CDOT and the County.

CO 83 ACCESS STUDY



CO-83 Access Control Plan Page 10 of 14

0 200 400 800 Feet

Legend

	Mileposts		Right-In, Right-Out
	Parcels		Emergency Access Only
	Full Movement (Signalized or Potential Roundabout)		Right-In Only
	Full Movement (Unsignalized)		Proposed Cross/Shared Property Access*
	Access Closed		Existing Cross/Shared Property Access*
	3/4 Movement (No Left Out)		Proposed Future Roadway

Notes

1. The current State Highway Access Code shall govern any unresolved discrepancies regarding access decisions.
 2. All access points are subject to consolidation upon the combining or subdividing of any lots under a single ownership or controlling interest.
 3. All access locations +/- 50 feet (0.01 mile) unless otherwise noted.
 4. The type, number, and storage length of lanes may be determined by a separate traffic study to be completed at the time of the actual design and implementation of the access plan and to ensure that the design does not create operational and/or safety issues.
 5. Full movement access with potential to become/remain signalized or change to other full movement control, such as a roundabout. The design of any intermediate/final intersection control changes will be completed under a separate study to ensure that the design complies with the recommendations of the access control plan and does not create operational and/or safety issues.
 6. A 3/4 movement configuration means that vehicles can turn right into the access, turn right out of the access, and turn left into the access.
- *Arrows represent two properties that already have shared access or could have shared access in the future. The placement of the arrows in the figure are not meant to identify the location of any future shared access. The location of future shared access would be determined through a cooperative and public effort between the property owners and/or CDOT and the County.

CO 83 ACCESS STUDY



CO-83 Access Control Plan Page 11 of 14

0 200 400 800 Feet

Legend

- | | |
|--|--|
| Milepoints | Right-In, Right-Out |
| Parcels | Emergency Access Only |
| Full Movement (Signalized or Potential Roundabout) | Right-In Only |
| Full Movement (Unsignalized) | Proposed Cross/Shared Property Access* |
| Access Closed | Existing Cross/Shared Property Access* |
| 3/4 Movement (No Left Out) | Proposed Future Roadway |

Notes

1. The current State Highway Access Code shall govern any unresolved discrepancies regarding access decisions.
 2. All access points are subject to consolidation upon the combining or subdividing of any lots under a single ownership or controlling interest.
 3. All access locations +/- 50 feet (0.01 mile) unless otherwise noted.
 4. The type, number, and storage length of lanes may be determined by a separate traffic study to be completed at the time of the actual design and implementation of the access plan and to ensure that the design does not create operational and/or safety issues.
 5. Full movement access with potential to become/remain signalized or change to other full movement control, such as a roundabout. The design of any intermediate/final intersection control changes will be completed under a separate study to ensure that the design complies with the recommendations of the access control plan and does not create operational and/or safety issues.
 6. A 3/4 movement configuration means that vehicles can turn right into the access, turn right out of the access, and turn left into the access.
- *Arrows represent two properties that already have shared access or could have shared access in the future. The placement of the arrows in the figure are not meant to identify the location of any future shared access. The location of future shared access would be determined through a cooperative and public effort between the property owners and/or CDOT and the County.

CO 83 ACCESS STUDY



CO-83 Access Control Plan Page 12 of 14

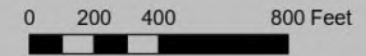

Legend

- | | | | |
|--|--|--|--|
| | Milepoints | | Right-In, Right-Out |
| | Parcels | | Emergency Access Only |
| | Full Movement (Signalized or Potential Roundabout) | | Right-In Only |
| | Full Movement (Unsignalized) | | Proposed Cross/Shared Property Access* |
| | Access Closed | | Existing Cross/Shared Property Access* |
| | 3/4 Movement (No Left Out) | | Proposed Future Roadway |

Notes

1. The current State Highway Access Code shall govern any unresolved discrepancies regarding access decisions.
 2. All access points are subject to consolidation upon the combining or subdividing of any lots under a single ownership or controlling interest.
 3. All access locations +/- 50 feet (0.01 mile) unless otherwise noted.
 4. The type, number, and storage length of lanes may be determined by a separate traffic study to be completed at the time of the actual design and implementation of the access plan and to ensure that the design does not create operational and/or safety issues.
 5. Full movement access with potential to become/remains signalized or change to other full movement control, such as a roundabout. The design of any intermediate/final intersection control changes will be completed under a separate study to ensure that the design complies with the recommendations of the access control plan and does not create operational and/or safety issues.
 6. A 3/4 movement configuration means that vehicles can turn right into the access, turn right out of the access, and turn left into the access.
- *Arrows represent two properties that already have shared access or could have shared access in the future. The placement of the arrows in the figure are not meant to identify the location of any future shared access. The location of future shared access would be determined through a cooperative and public effort between the property owners and/or CDOT and the County.

CO 83 ACCESS STUDY



CO-83 Access Control Plan Page 13 of 14

0 200 400 800 Feet

Legend

- | | | | |
|--|--|--|--|
| | Milepoints | | Right-In, Right-Out |
| | Parcels | | Emergency Access Only |
| | Full Movement (Signalized or Potential Roundabout) | | Right-In Only |
| | Full Movement (Unsignalized) | | Proposed Cross/Shared Property Access* |
| | Access Closed | | Existing Cross/Shared Property Access* |
| | 3/4 Movement (No Left Out) | | Proposed Future Roadway |

Notes

1. The current State Highway Access Code shall govern any unresolved discrepancies regarding access decisions.
 2. All access points are subject to consolidation upon the combining or subdividing of any lots under a single ownership or controlling interest.
 3. All access locations +/- 50 feet (0.01 mile) unless otherwise noted.
 4. The type, number, and storage length of lanes may be determined by a separate traffic study to be completed at the time of the actual design and implementation of the access plan and to ensure that the design does not create operational and/or safety issues.
 5. Full movement access with potential to become/remainsignalized or change to other full movement control, such as a roundabout. The design of any intermediate/final intersection control changes will be completed under a separate study to ensure that the design complies with the recommendations of the access control plan and does not create operational and/or safety issues.
 6. A 3/4 movement configuration means that vehicles can turn right into the access, turn right out of the access, and turn left into the access.
- *Arrows represent two properties that already have shared access or could have shared access in the future. The placement of the arrows in the figure are not meant to identify the location of any future shared access. The location of future shared access would be determined through a cooperative and public effort between the property owners and/or CDOT and the County.

CO 83 ACCESS STUDY



CO-83 Access Control Plan Page 14 of 14

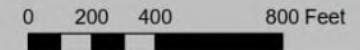

Legend

- | | | | |
|--|--|--|--|
| | Milepoints | | Right-In, Right-Out |
| | Parcels | | Emergency Access Only |
| | Full Movement (Signalized or Potential Roundabout) | | Right-In Only |
| | Full Movement (Unsignalized) | | Proposed Cross/Shared Property Access* |
| | Access Closed | | Existing Cross/Shared Property Access* |
| | 3/4 Movement (No Left Out) | | Proposed Future Roadway |

Notes

1. The current State Highway Access Code shall govern any unresolved discrepancies regarding access decisions.
 2. All access points are subject to consolidation upon the combining or subdividing of any lots under a single ownership or controlling interest.
 3. All access locations +/- 50 feet (0.01 mile) unless otherwise noted.
 4. The type, number, and storage length of lanes may be determined by a separate traffic study to be completed at the time of the actual design and implementation of the access plan and to ensure that the design does not create operational and/or safety issues.
 5. Full movement access with potential to become/remainsignalized or change to other full movement control, such as a roundabout. The design of any intermediate/final intersection control changes will be completed under a separate study to ensure that the design complies with the recommendations of the access control plan and does not create operational and/or safety issues.
 6. A 3/4 movement configuration means that vehicles can turn right into the access, turn right out of the access, and turn left into the access.
- *Arrows represent two properties that already have shared access or could have shared access in the future. The placement of the arrows in the figure are not meant to identify the location of any future shared access. The location of future shared access would be determined through a cooperative and public effort between the property owners and/or CDOT and the County.

This page intentionally left blank.